

2014



STORE FIXTURES & POP COMPONENTS

STORE FIXTURE HARDWARE & POP COMPONENTS

Pgs. 74-131

SLATWALL & SLATWALL SYSTEMS



E-Z Slatwall



Double Sided Aluminum Slatwall Panels

Light Duty PVC Slatwall Panels

Connectors (2, 3 & 4 Way)



Fasteners (Rivets)



Merchandising Strips



SIGN HOLDERS

For Wire



Bendable



Free Standing

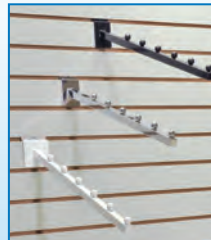

Slatwall Hardware

IMPACT PROTECTION



Fixture & Wall Bumper Guards



Corner Guards

Suction Cups



Brackets & Standards



Steel Tubing & Accessories



REVOLVING TURNTABLES

Metal Lazy Susan

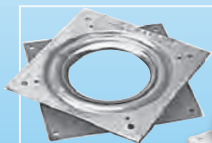

Motorized



Foam Tape (Double Stick)



Acrylic Display Products



ACRYLIC DISPLAY PRODUCTS	96-103	PRICE TAG MOULDINGS		SIGN HOLDERS	
ACRYLIC FABRICATING PRODUCTS	104-106	Aluminum w/Holes	75	Label Holders for Wire	80
BINNING STRIPS	107	Dual Price & Inventory Tickets	76	Price Tag Holders for Wire	80
BRACKETS & STANDARDS	120-121	For Glass, Wood & Metal Shelves	79	Sign Holders for Wire	80
CONNECTORS (2, 3 & 4-Way)	90	For Shelves & Shelf Channels	78	Tubing & Accessories for Sign Holders	81
DUAL LOCK™ FASTENING SYSTEMS	89	For Wire & Cardboard Displays	78	SLATWALL & SLATWALL SYSTEMS	
FASTENERS	86-87	Plastic "C" Channel Ticket Mouldings	76	Double Sided Aluminum Slatwall Panels	110
Rivets	86	Plastic Flat Back (Color/Clear)	74-75, 77	E-Z Slatwall	108-109
FOAM TAPE (Double Stick)	89	Spiral Bound Holders	76	Great Wall Slatwall System	111
GRIDWALL & ACCESSORIES	95, 118-119	Tube Tickets	76	Light Duty PVC Slatwall Panels	110
HANG TABS	84	REVOLVING TURNTABLES/BASES		Slatwall Inserts	112
HOOK & LOOP (Velcro)	88	Aluminum Revolving Turntables	91	Slatwall Text Panels	113
IMPACT PROTECTION		Metal Lazy Susans	91	Wood Slatwall Panels	112
Corner Guards	126, 130-131	Motorized	92-93	SLATWALL ACCESSORIES	94-95
Fixture & Wall Bumper Guards	124-126	Plastic Lazy Susans	91	SLATWALL HARDWARE	114-117
Impact Protection System	127-132	S-HOOKS	81	STEEL TUBING & ACCESSORIES	123
LITERATURE & SIGN HOLDERS	94-95	SHELF GUARDS	81	SUCTION CUPS	84
MAGNETIC STRIPS	85	SIGN HOLDERS		TABLE SKIRTING CLIPS	81
MERCHANDISING STRIPS	81, 122	Bendable Sign Holders	80	TURNTABLES	91
PEG BOARD ACCESSORIES	122	Free Standing/Wall Mount Sign Holders	82-83	VELCRO® HOOK & LOOP	88

SEE PAGES 1007-1023 FOR A - Z INDEX

PLASTIC FLAT BACK PRICE TAG COLOR MOULDINGS

Cut Program Available
SEE PAGE 29 FOR DETAILS

Without Adhesive Backing

Lengths: 12 Ft. • Material: Styrene
Colors Available

*WH - White *BK - Black

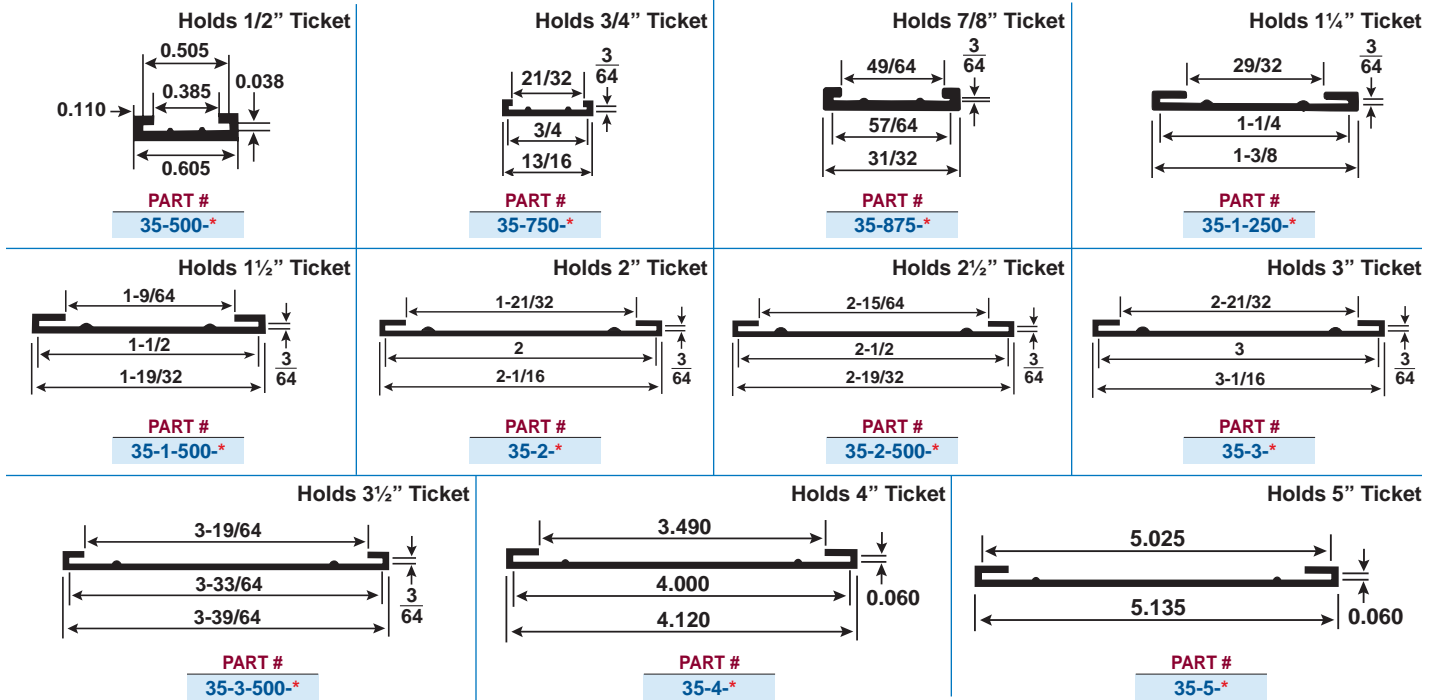

With Adhesive Backing

Lengths: 12 Ft. • Material: Styrene
Colors Available

*WH - White *BK - Black

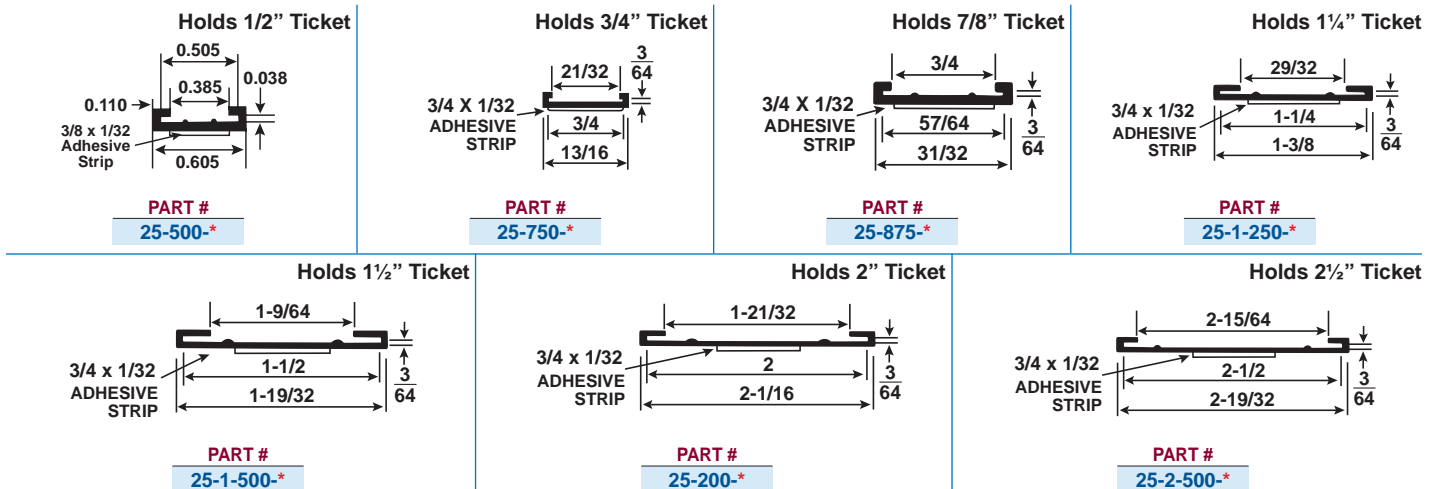

PLASTIC FLAT BACK PRICE TAG CLEAR MOULDINGS

Cut Program Available
SEE PAGE 29 FOR DETAILS

Without Adhesive Backing
Lengths: 12 Ft. • Material: Butyrate • Clear

Holds 1/2" Ticket

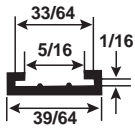

PART #
43-500

Holds 3/4" Ticket

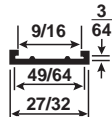

PART #
43-750

Holds 7/8" Ticket

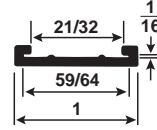

PART #
43-875

Holds 1 1/4" Ticket



PART #
43-1-250

Holds 1-1/2" Ticket

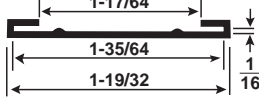

PART #
43-1-500

Holds 2" Ticket

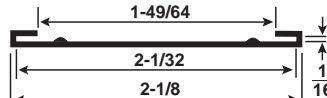

PART #
43-2

Holds 3" Ticket

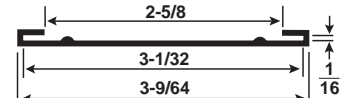

PART #
43-3

With Adhesive Backing

Lengths: 12 Ft. • Material: Butyrate • Clear

Holds 1/2" Ticket

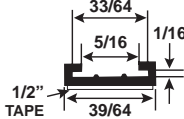

PART #
43A-500

Holds 3/4" Ticket

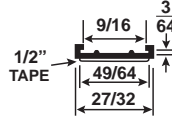

PART #
43A-750

Holds 7/8" Ticket

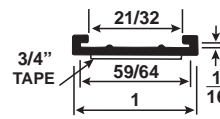

PART #
43A-875

Holds 1" Ticket

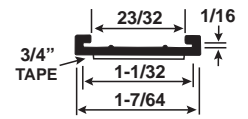

PART #
43A-100

Holds 1 1/4" Ticket

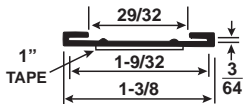

PART #
43A-1-250

Holds 1 1/2" Ticket

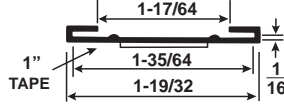

PART #
43A-1-500

Holds 2" Ticket

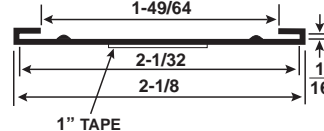

PART #
43A-2

Holds 3" Ticket

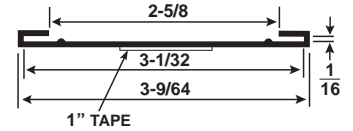

PART #
43A-3

ALUMINUM PRICE TAG MOULDINGS w/HOLES

With counter sunk hole spacing every 7"

For 5/8" Price Tag

PART #	Length
ALU151*	120 Per Ft. 600 Ft.+

With counter sunk hole spacing every 8"

For 1" Price Tag

PART #	Length
ALU157*	120 Per Ft. 600 Ft.+

Lengths: 12 Ft.
Finishes Available

- *P, PH (w/holes) - Polished/Mechanical - Shiny/Mirror Finish
- *BSH (w/holes) - Brushed Satin - Lightly Brushed (Shows Grain) Satin Finish
- *S, SH (w/holes) - Satin/Clear Anodized - Dull Matte Finish

With counter sunk hole spacing every 7"

For 1 1/4" Price Tag

PART #	Length
ALU154*	120 Per Ft. 600 Ft.+

With punched hole spacing every 6"

For 1 1/4" Price Tag

PART #	Length
ALU618*	120 Per Ft. 600 Ft.+

For Universal Price Tag (No Holes)

PART #	Length
ALU1316*	120 Per Ft. 600 Ft.+

TICKET MOULDING FOR SCANNABLE TICKETS

TUBE TICKETS

With Adhesive Backing

Material: Clear Butyrate • Lengths: 12 Ft.

Cut Program Available
SEE PAGE 29 FOR DETAILS

Holds 1/2" Ticket

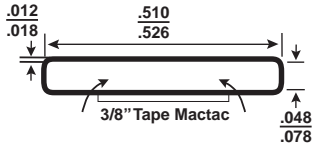

PART #
2050-CL

Holds 3/4" Ticket

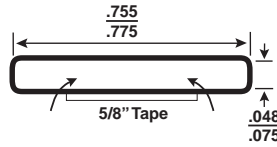

PART #
2051-CL

Holds 1" Ticket

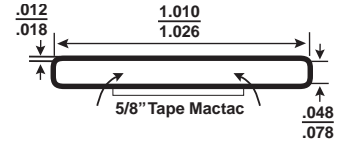

PART #
2052-CL

FOR PRICE AND INVENTORY TICKETS

- Material: Clear PVC/Dual Durometer
- Lengths: 12 ft.
- 1-1/4" ticket with flip up front and white foam tape

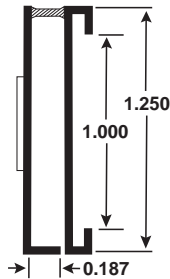

PART #
1125FT

- Material: Clear Styrolux
- Lengths: 8 ft.
- With white foam tape
- Hinged

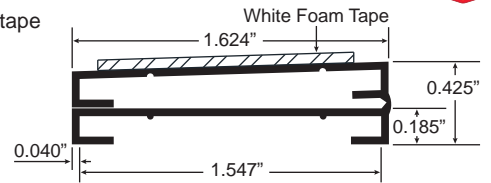

PART #
55-5955

For 1-1/2" Ticket

New

- Material: Clear PVC/Dual Durometer
- Lengths: 4 ft.
- Used as double ticket holder or clips in many fixtures
- Hinged

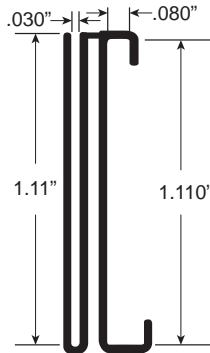

PART #
55-1220

- Material: Clear PVC
- Lengths: 8 ft.
- With white foam tape
- Hinged

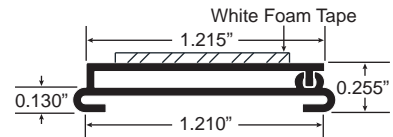

PART #
55-5953

For 1-1/4" Ticket

New

SPIRAL BOUND HOLDERS

Without Adhesive

Material: Styrene • Lengths: 12 Ft.
Available in Black or White

Center Divider



PART #

SBT-CENTER-BK
SBT-CENTER-WH

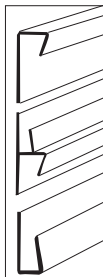

Top / Bottom Cap

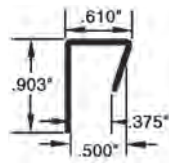

PART #

SBT-CAP-BK
SBT-CAP-WH

- Material: Styrene
- Lengths: 8 ft.
- Available in White or Black, with clear front
- Lets price tag and inventory tag be seen at once

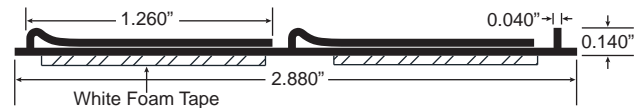

PART # COLOR

55-5950-BK Black

55-5950-WH White

Dual 1-1/4" Tickets

New

PRICE TICKETS FOR SCANNABLE LABELS

FLATBACK TICKETS

With Clear Rubber Based Adhesive for Permanent Installation (*unless otherwise noted*)

- Butyrate Tickets: Provides most clarity
- Styrolux Tickets: Provides more clarity than PVC, but more economical
- PVC Tickets: Most Economical

Colors Available

*CL - Clear *WH - White *BK - Black

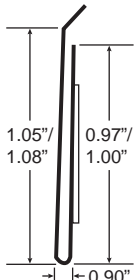
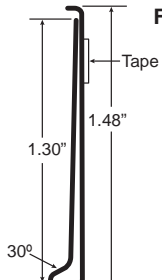
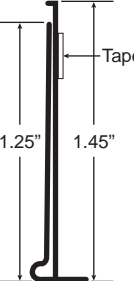
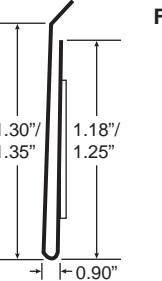
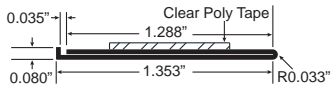
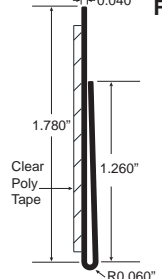
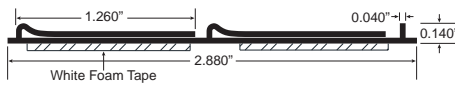
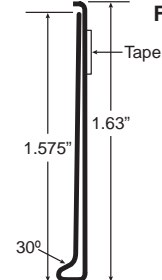
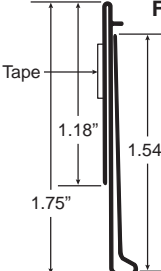
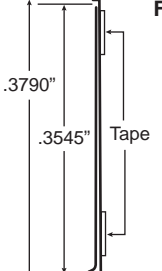
<ul style="list-style-type: none"> • Material: Clear Butyrate • Lengths: 12 ft. <p>PART # 6184-12</p>  <p>Fits 1" Ticket</p>	<ul style="list-style-type: none"> • Material: PVC • Lengths: 4 ft. <p>PART # 55-1250*</p>  <p>Fits 1-1/4" Ticket</p>
<ul style="list-style-type: none"> • Material: PVC • Lengths: 4 ft. • Guide bar aids accurate installation <p>PART # 55-1260*</p>  <p>Fits 1-1/4" Ticket</p>	<ul style="list-style-type: none"> • Material: Clear Butyrate • Lengths: 12 ft. <p>PART # 6186-12</p>  <p>Fits 1-1/4" Ticket</p>
<ul style="list-style-type: none"> • Material: PVC • Lengths: 8 ft. • Anti-tampering closed top <p>PART # 55-5948*</p>  <p>Fits 1-1/4" Ticket</p> <p>New</p>	<ul style="list-style-type: none"> • Material: Clear Styrolux • Lengths: 8 ft. • Apply with adhesive or mechanical fastener <p>PART # 55-5949 55-5949A ^ Without Adhesive</p>  <p>Fits 1-1/4" Ticket</p> <p>New</p>
<ul style="list-style-type: none"> • Material: Styrene Base w/Styrolux cover • Lengths: 8 ft. • Available in White or Black, with clear front • Lets price tag and inventory tag be seen at once <p>PART # COLOR 55-5950-BK Black 55-5950-WH White</p>  <p>Dual 1-1/2" Tickets</p> <p>New</p>	<ul style="list-style-type: none"> • Material: PVC • Lengths: 4 ft. <p>PART # 55-1550*</p>  <p>Fits 1-1/2" Ticket</p>
<ul style="list-style-type: none"> • Material: PVC • Lengths: 4 ft. <p>PART # 55-1551*</p>  <p>Fits 1-1/2" Ticket</p>	<ul style="list-style-type: none"> • Material: PVC • Lengths: 4 ft. • Great for pallet racks <p>PART # 55-3500*</p>  <p>Fits 3-1/2" Ticket</p>

TICKET MOULDING FOR SCANNABLE TICKETS

FOR WIRE AND CARDBOARD DISPLAYS

Cut Program Available

SEE PAGE 29 FOR DETAILS

Colors Available

*CL - Clear *WH - White *BK - Black

- Material: PVC
- Lengths: 4 ft. or pre-cut 2-1/8" pieces
- Snaps on to 1/4" wire



PART # **LENGTH**
55-1270-CL 2-1/8"

PART # **LENGTH**
55-1275-CL 4 ft.

Fits 1-1/4" Ticket

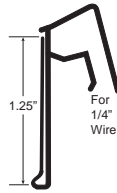

- Material: Butyrate
- Lengths: 4 ft.
- Clips on to cardboard

Fits 1-1/2" Ticket

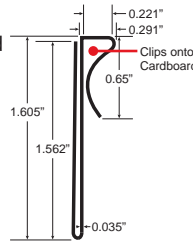

PART #
830-CL

Fits 2" Ticket



- Material: PVC
- Runs to order
- Minimums and color match fees may apply, please inquire.

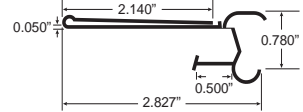

PART #
55-5962*

FOR SHELVES AND SHELF CHANNELS

Colors Available

*CL - Clear *WH - White *BK - Black

- Material: Durable Polypropylene
- Fits 1-1/4" shelving channel
- Signage faces up, down or perpendicular for two-sided viewing

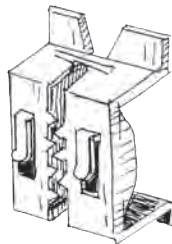

PART #
GTS-01

- Material: Clear PVC with Grip-Tite fingers
- Fits 7/8" to 1-1/4" shelving channel
- Signs display in the flag position
- Can be viewed from either aisle direction
- Holds sign stock to .080"

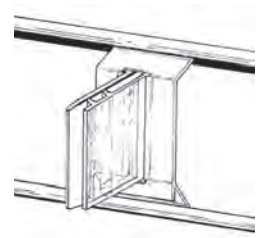

PART #
GTS-15

- Material: Clear PVC with Grip-Tite fingers
- Fits 1-1/4" shelving channel
- Signs display in the flat position
- Holds sign stock to .080"

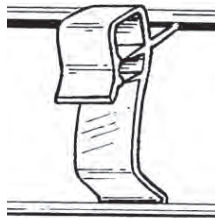

PART #
GTS-14

- Material: PVC
- Lengths: 4 ft.
- Snaps into most 1-1/4" metal shelves

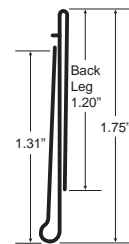

Fits 1-1/4" Ticket

PART #
55-1251*

- Material: Clear Styrolux
- Lengths: 8 ft.
- Fits most shelf channels



PART #
55-5952

Fits 1-1/4" Ticket



- Material: Clear Styrolux with white foam tape
- Lengths: 8 ft.
- Used over shelf with built in shelf guard
- Used under shelf for easy access
- Can be free standing without adhesive

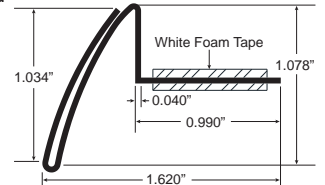

Fits 1-1/4" Ticket



PART #
55-5957A
55-5957

- Material: PVC
- Lengths: 4 ft.
- Attaches to top of shelf with permanent adhesive

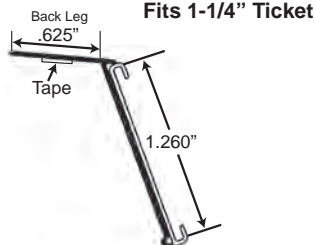

PART #
55-1265*

Fits 1-1/4" Ticket

- Material: Clear Butyrate
- Lengths: 4 ft.
- 2" ticket snaps on to 1-1/4" channel

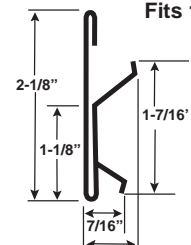

Fits 1-1/4" Ticket

PART #
867-CL

PLASTIC PRICE TAG & SIGN HOLDERS FOR GLASS, WOOD & METAL SHELVES

- Fits 3/16", 1/4", 7/32" glass binning and divider applications
- Material: Clear Butyrate
- Lengths: 2-7/8"
- Holds 7/8" H ticket

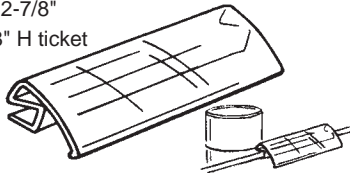

PART #
6148-03

- Fits 3/16"-5/16" glass shelf
- Material: Clear Rigid PVC
- Lengths: 12 ft.
- Holds 1-1/4" H ticket

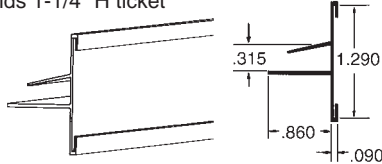

PART #
6165-12

- Fits 7/32"-1/4" glass shelf
- Material: Clear Butyrate
- Holds 3/8" H ticket

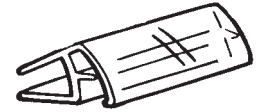

PART # LENGTH
6105-01 1-1/2"
6105-03 3"
6105-05 5-1/2"

- Fits 7/32"-1/4" glass shelf
- Material: Clear Butyrate
- Holds 7/8" H ticket

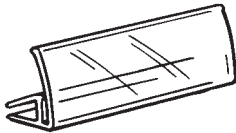

PART # LENGTH
6121-03 2-7/8"
6121-48 48"
6121-60 60"

- Fits 7/32"-1/4" glass binning
- Material: Clear Butyrate
- Lengths: 2-7/8"
- Holds 7/8" H ticket

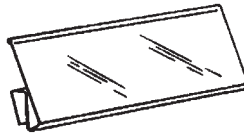

PART #
6119-03

- Fits 1/4" glass shelf
- Material: Clear Butyrate
- Lengths: 12 ft.
- Holds 1/2" ticket or rigid sign



PART #
52-CL

- Fits 1/4" glass shelf
- Material: Styrene
- Lengths: 12 ft.
- Holds 1" H ticket

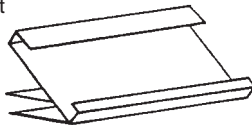

PART # COLOR
40-WH Black
40-BK White

- Fits 1/4" glass shelf
- Material: Clear Butyrate
- Holds rigid sign

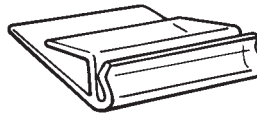

PART # LENGTH
6197-01 1"
6197-48 48"

- Fits 3/8" glass shelf
- Material: Clear Butyrate
- Holds 7/8" H ticket

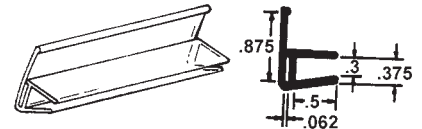

PART # LENGTH
6133-03 2-7/8"
6133-60 60"

- Fits 5/8" thick shelf
- Material: Butyrate
- Lengths: 48"
- Holds 2" H ticket

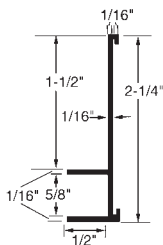

PART # COLOR
1809-BK Black
1809-WH White

- Fits 5/8"-3/4" wood shelf
- Material: Clear Butyrate
- Holds 7/8" H ticket

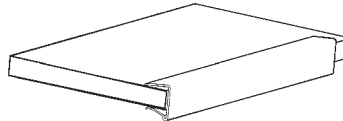

PART # LENGTH
6145-03 2-7/8"
6145-60 60"

- Fits 3/4" metal shelf
- Material: Clear Butyrate
- Lengths: 2-7/8"
- Holds 7/8" H ticket

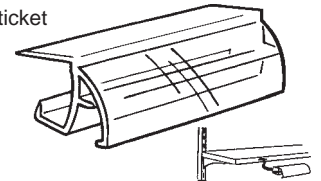

PART #
6136-03

- Fits 3/4" shelf
- Material: Clear Butyrate
- Lengths: 12 ft.
- Holds 5/8"-3/4" H ticket

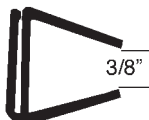

PART #
6762-12

- Fits 3/4"-7/8" shelf
- Material: Clear Rigid PVC
- Lengths: 12 ft.
- Holds 1-1/4" H ticket

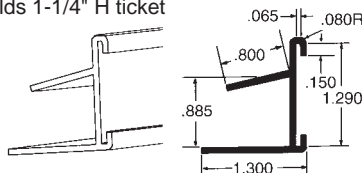

PART #
6135-12

- Fits 1" shelves or tubing
- Material: Clear Butyrate
- Lengths: 2-7/8"
- Holds 1" H ticket

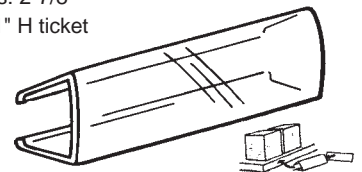

PART #
6140-03

MERCHANDISING ESSENTIALS

SIGN HOLDERS FOR WIRE

GRIP-TITE WIRE BASKET SIGN HOLDER

- Material: Clear PVC
- Fits wire up to 3/8" diameter
- Dual durometer ribs holds material up to 0.080" thick in flush mount position
- Overall dimensions: 1/2" x 1" L

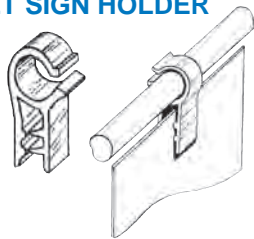

PART #
GTS-18

GRIP-TITE WIRE FLAG SIGN HOLDER

- Material: Clear PVC
- Fits wire up to approximately .200" (3/16") and has gripper ribs to hold securely
- Dual durometer ribs securely holds signage up to .080" thick
- Overall dimensions: 1" L x 11/16" W



PART #
GTS-27

POWER PANEL CLIP

- Material: White PVC
- Works with wire up to 1/4" diameter
- Holds 1/8" - "B" Flute corrugated signage material
- Overall dimensions: 1" W x 2" H



PART #
PPC-16

ALL PURPOSE ADHESIVE CLIP

- Material: White Styrene
- Easily works with wire up to 1/4" with its inside diameter of .300"
- Holds signage up to .187 thick
- Can work two ways: (1) over wire and apply signage to adhesive pad or (2) apply adhesive pad to flat surface
- Overall dimensions: 1" W x 1" L



PART #
APA-105

LABEL HOLDERS FOR WIRE

UPC LOCKING STRAP LABEL HOLDER

- Material: Clear PVC
- Easily attaches to wire/grids up to 1/4" diameter
- Label area is 1-1/4" x 3" and is quipped with label setting guide rail

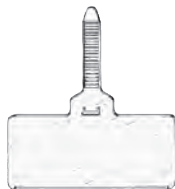

PART #
LH-3

PRICE TAG HOLDERS FOR WIRE

- Material: Clear Butyrate
- Works with 3/16" diameter wire
- Holds 7/8" H ticket
- Overall length: 2-7/8" L

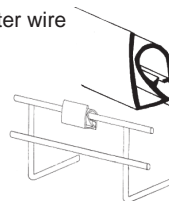

PART # **SIZE**
6152-03 2-7/8" L

- Material: Clear Butyrate
- Work with 1/4" diameter wire
- Holds 1" H ticket

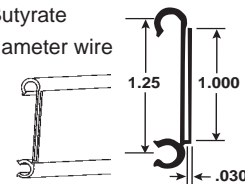

PART # **SIZE**
6125-03 2-7/8" L
PART # **SIZE**
6125-12 1" L

SECURE-LOK LABEL HOLDER

- Material: Clear Polypropylene
- Easily attaches and locks on wire up to 3/8" diameter
- Label area: 1-1/4" x 3-1/2"

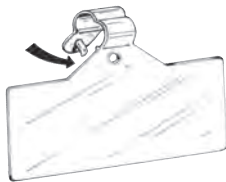

PART #
LH-4

- Material: Clear Butyrate
- Works with 3/16" diameter wire
- Holds 7/8" H ticket
- Overall length: 2-7/8"

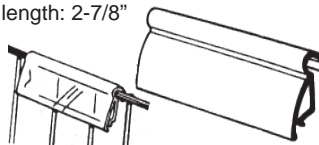

PART # **SIZE**
6153-03 2-7/8" L

- Material: Clear PVC
- This flexible grip works with 3/16" - 1/4" diameter wire
- Holds 1" H ticket

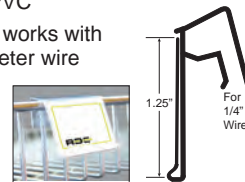

PART # **LENGTH**
55-1270-CL 2-1/8"
PART # **LENGTH**
55-1275-CL 4"

BENDABLE SIGN HOLDERS FOR SMALL LIGHT WEIGHT SIGNAGE

TAPERED WOBBLERS

- Material: Clear PVC
- With adhesive on both ends, this works on a variety of in store fixtures or displays
- Tapered body produces extra motion



PART # **LENGTH**
TW-60 6"
TW-80 8"

SPRING WOBBLER

- Material: White Styrene bases (3/4" x 3/4")
- Metal Spring 1" long
- With adhesive on both sides this can be used virtually anywhere you can imagine
- Metal spring creates attention grabbing action

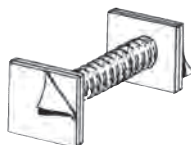

PART #
J2401

FLEXIBLE ALUMINUM SIGN HOLDERS

- Material: Aluminum
- With adhesive on both ends, this too can be just about anywhere you need
- Easily bends and adjusts to any shape you need



PART # **LENGTH**
FSH-33 3"
FSH-36 6"

MERCHANDISING ESSENTIALS

SHELF GUARD

Material: Clear Butyrate

FITS GLASS:

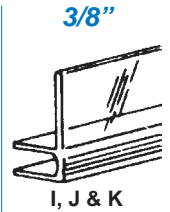
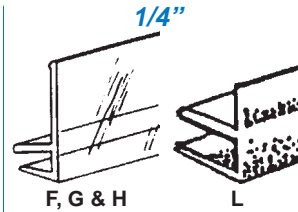
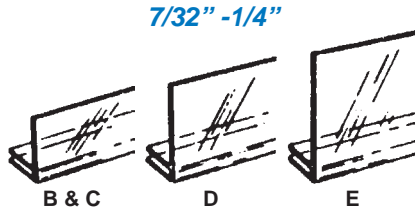
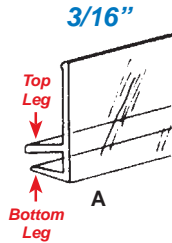
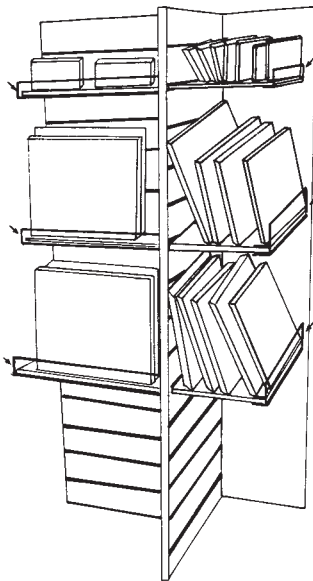

	PART #	FITS GLASS:	HEIGHT	TOP LEG	BOTTOM LEG	LENGTH
A	SE-316-4	3/16"	7/16"	-	-	48"
B	SE/248	7/32"-1/4"	2"	3/8" L	5/16" L	48"
C	SE/260	7/32"-1/4"	2"	3/8" L	5/16" L	60"
D	SE/348	7/32"-1/4"	3"	3/8" L	5/16" L	48"
E	SE/448	7/32"-1/4"	4"	3/8" L	5/16" L	48"
F	SE-14-4	1/4"	3/4"	-	-	48"
G	SE-14-5	1/4"	3/4"	-	-	60"
H	SE-14-6	1/4"	3/4"	-	-	72"
I	SE-38-4	3/8"	7/16"	-	-	48"
J	SE-38-5	3/8"	7/16"	-	-	60"
K	SE-38-6	3/8"	7/16"	-	-	72"
	PART #	FITS GLASS:	HEIGHT	TOP LEG	BOTTOM LEG	LENGTH
L	152-CL	1/4"	1/4"	-	-	12 ft.

PLASTIC TUBING & ACCESSORIES FOR SIGN HOLDERS

WHITE ROUND PLASTIC TUBING



NOTE: White Styrene & White PVC color may not be identical

FOR END CAPS & GLIDES, SEE PAGES 244-252

PART #	O.D.	I.D.	MATERIAL	LENGTH
800R-1	1"	15/16"	Styrene	4 ft.
800R-1-25	1-1/4"	1-3/16"	Styrene	4 ft.
PD125-WH	1-1/4"	1-1/8"	PVC	8 ft.

POLE SIGN CLAMP

Material: Styrene

- Color: White
- For use with 1" tubing
- Excellent for use on cut case display



PART #	TUBE O.D.
PSC-10	1"

POLE TOP SIGN HOLDERS

Material: Styrene

- Color: White
- For use with 1" & 1-1/4" tubing
- Holds signs up to .080" thick

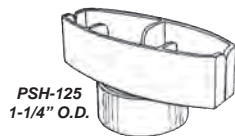
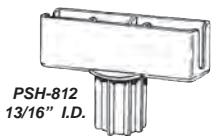

PART #	TUBE O.D.	TUBE I.D.
PSH-812	1"	13/16"
PSH-125	1-1/4"	N/A

TABLE SKIRTING CLIPS

Material: Rigid PVC
Length: 3" Long



Fits
1-1/2"
Board



Fits
3/4"
Board

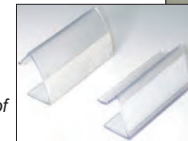

All clips come with strip of velcro® to attach fabric.

PART #	DESCRIPTION	FITS:
TSC-0750	Without Hook	3/4"
TSC-0750H	With Hook	3/4"
TSC-1500H	With Hook	1-1/2"

MERCHANDISING STRIPS

Material: Polypropylene

- Color: White
- 12 Hook strip loads fast and easy
- Product "Loks" on for secure shipment
- Header measures 3" W x 1-3/8" H



PART #	LENGTH	WIDTH	HOOK SPACING
MS-PL24	24-1/2"	1-1/8"	2"
MS-PL30	30"	1-1/8"	2-1/2"

S-HOOKS

Material: Zinc Plated Steel

- .080" • 1-3/4" Long
- Hang from shelf edge or wire fixtures
- Strip Hooks available in "Open Ended" & "Pinched"
 - Open ended for use with all merchandising strips
 - Pinched style assures strip stays on hook



PART #	TYPE
SH-50	Open
SH-75	Pinched

MERCHANDISING ESSENTIALS

FREE STANDING & WALL MOUNT SIGN HOLDERS

MOST CAN BE USED IN HORIZONTAL AND VERTICAL APPLICATIONS

STRAIGHT CENTER MOUNT SIGN/CARD HOLDER

- Material: Clear Styrene
- Holds material up to 1/32" thick
- 1-1/2" W x 1-3/4" L base with 1/4" H secure grip sign holder



PART #	LENGTH
SCH-1	1-3/4"

ANGLED TABLETOP SIGN HOLDER

- Material: Clear Styrene
- Holds material up to 1/32" thick
- 1-9/16" L x 2-3/8" base with 7/16" H slanted sign holder

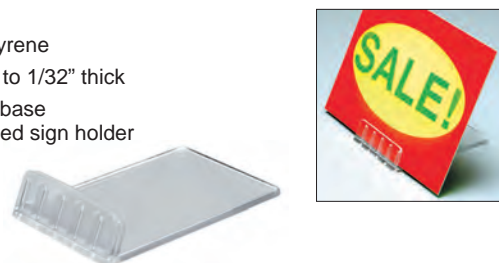

PART #	LENGTH
ACH	1-9/16"

COUNTER TOP SIGN HOLDERS

- Material: Clear Rigid PVC
- Holds material up to 1/8" thick
- Peel and stick adhesive on 1" back
- 1" W x 3" or 6" L base x 3/4" H tension grip sign holder



PART #	LENGTH
GTS-77-3	3"
GTS-77-6	6"

STRAIGHT CENTER MOUNT SIGN HOLDER

- Material: White Styrene
- Holds material 0.60 to 0.70 thick
- Peel and stick foam back
- 1-1/8" L x 1/2" W base x 7/16" H secure grip sign holder

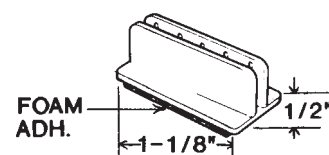

PART #	LENGTH
J2223-3D	1-1/8"

PRICE CHANNEL SIGN HOLDER

- Material: Clear PVC
- Holds material up to .080" thick
- Peel and stick foam back
- 1/2" W x 1" or 3" L base x 7/16" H sign holder w/grip-tate fingers to hold card stock securely

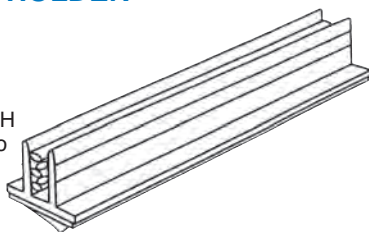

PART #	LENGTH
GTS-16-1	1"
GTS-16-3	3"

GRIP-TITE CHANNEL STRIP SIGN HOLDER

- Material: Clear PVC
- Holds material up to 0.080" thick
- Peel and stick foam back
- 1" or 3" L x 3/4" H mounting base x 1/2" H sign holder w/grip-tate finger to hold signs in flush mount position

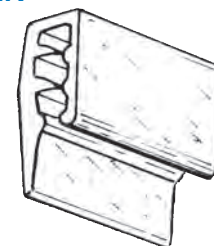

PART #	LENGTH
GTS-17-1	1"
GTS-17-3	3"

PRICE CHANNEL SIGN HOLDER

- Material: Clear PVC
- Holds material up to 0.60" thick
- Peel and stick foam back
- 1" W x 3" or 6" L base x 3/4" H sign holder w/grip-tite fingers and built in moving flexibility for high traffic areas where signs get hit



PART #	LENGTH
GTS-20-3	3"
GTS-20-6	6"

GRIP-TITE CHANNEL STRIP SIGN HOLDER

- Material: Clear PVC
- Holds material up to 0.080" thick
- Peel and stick foam back
- Wide base for extra stability
- 1" W x 1" or 3" L base x 7/16" H sign holder w/grip-tite fingers to hold card stick securely

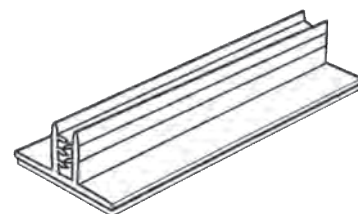

PART #	LENGTH
GTS-25-1	1"
GTS-25-3	3"

MERCHANDISING ESSENTIALS

FREE STANDING & WALL MOUNT SIGN HOLDERS

MOST CAN BE USED IN HORIZONTAL AND VERTICAL APPLICATIONS

COUNTER TOP SIGN HOLDER

- Material: PVC
- Lengths: 12 in.
- Color: Available in Black ***(BK)**, White ***(WH)** & Silver ***(SI)**
- Holds material 1/16" - 1/8" thick
- 3.25" W x 12" L with dual durometer grip



PART #
SNH-325-12*



COUNTER TOP SIGN CHANNEL

- Material: PVC
- Lengths: 8 ft.
- Color: Available in Black ***(BK)**, White ***(WH)** & Silver ***(SI)**
- Holds material 1/16" - 1/8" thick
- 3.25" W x 8" L with dual durometer grip

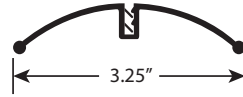

PART #
SNH-325-*



SPECIALTY SIGN HOLDER

- Material: Clear Butyrate
- Holds material up to 0.100" thick
- 1/2" H tension grip sign holder w/ 1-1/4" L x 1" deep curved mounting base to work w/shelving and showcases

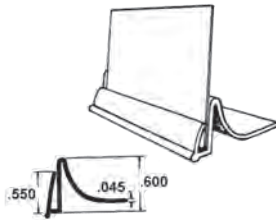

PART #	LENGTH
6201-01	1-1/4"

For quantities less than 100 pieces please inquire.

SIGN CHANNEL PVC/DUAL DUROMETER

- Material: PVC
- Lengths: 8 ft.
- Holds material 1/8" thick
- Peel and stick foam back
- 1/2" W base x 7/16" H with dual durometer grip

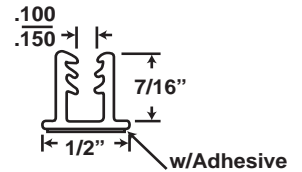

PART #	COLOR
106-4808-BK	Black
106-4808-WH	White

FREE STANDING CARD HOLDER WITHOUT ADHESIVE

- Material: Clear Butyrate
- Lengths: 12 ft.
- Fits material 1/16" & 1/8" thick
- 1-5/16" W base x 1/4" H

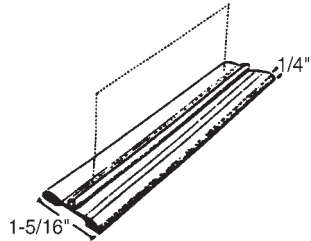

PART #	FITS CARD
32-CL	1/16"
33-CL	1/8"

FREE STANDING CARD HOLDER

- Material: White Styrene
- Lengths: 12 ft.
- Fits material 1/8" and 1/16"-1/4" thick
- 1" or 2" W flat base x 1/2" or 1" H

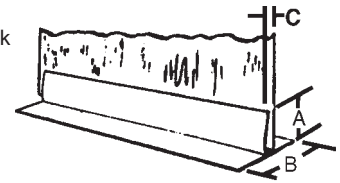

PART #	A	B	FITS CARD
24SM125-WH	1/2"	1"	1/8"
24-WH	1"	2"	1/16"-1/4"

CLEAR/PVC

- Material: Clear PVC
- Lengths: 12 ft.
- Holds material up to .060" thick
- 1-1/2" W base x 3/4" H

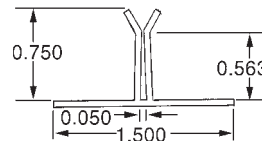

PART #
1255-CL

MERCHANDISING ESSENTIALS

SUCTION CUPS

MADE OF CLEAR UV RESISTANT PVC (Suction Cup Only)

SUPER SUCKER WITH MUSHROOM HEAD

- Sticks to any clean, dry, smooth, non-porous surface
- Accommodates a wide range of self-hanging products



PART #	DESCRIPTION
SC-134S	1-3/4" Diameter cup holds up to approximately 3 lbs.

SUCTION CUP WITH TACK

- Hold sign in place up to 3 lbs.
- Un-assembled



PART #	DESCRIPTION
SC-134T	1-3/4" Diameter cup w/plastic tack holds up to approximately 3 lbs.

MUSHROOM HEAD SUCTION CUP

- Simplified design accommodates a wide range of self-hanging products



PART #	DESCRIPTION
SC-34MH	3/4" Diameter cup holds up to approximately 1/2 lbs.
SC-118MH	1-1/8" Diameter cup holds up to approximately 1 lbs.
SC-134MH	1-3/4" Diameter cup holds up to approximately 3 lbs.
SC-212MH	2-1/2" Diameter cup holds up to approximately 7 lbs.

SUCTION CUP WITH ROTO HOOK

- Great for sign on strings or chains
- Heavyweight capacity is ideal for kitchen and bathroom use. Easily supports cloths, towels, utensils and accessories.



PART #	DESCRIPTION
SC-134RH	1-3/4" Diameter cup w/metal swivel roto hook holds up to approximately 3 lbs.

GRIP-TITE SUCTION CUP WITH VERTICAL SIGN HOLDER

- 1" diameter suction cup with attached sign holder
- Clear 1" Long vertical Grip-Tite sign holder holds material up to .080" thick
- For use on smooth non-porous surfaces



PART #
GTS-22

GRIP-TITE SUCTION CUP WITH FLUSH MOUNT SIGN HOLDER

- 1" diameter suction cup with attached sign holder
- Clear 1" Long flush mount Grip-Tite sign holder holds material up to .080" thick
- For use on smooth non-porous surfaces



PART #
GTS-23

"SNAP & HOLD" SUCTION CUP WITH FLAG SIGN HOLDER

- 1" diameter suction cup with attached flag sign holder
- Natural polypropylene re-usable clip comes with self piercing pin to securely grip signage up to .15" thick

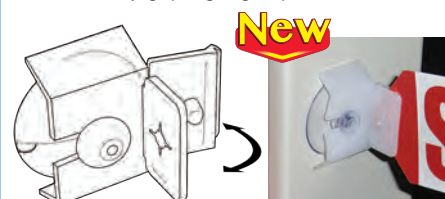

PART #
SPSC-607

HANG TABS

CLEAR HANG TABS WITH STRONG ADHESIVE BLEND WITH ANY PACKAGING

- Increase product exposure by using any variety of these tabs
- Quick and easy solutions to repair damaged packaging
- Speeds up rotation of inventory and allows customer to back shop by removing items from any area of the hook

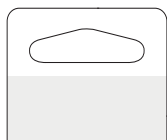

SLOTTED
CFV-7511

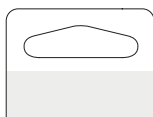

SLOTTED
CFV-6116



SLOTTED
RFV-0104



ROUND STYLE
CFV-6494

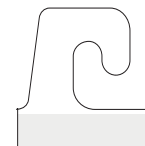

HOOK STYLE
SFV-6323

PART #	DIMENSIONS	HOLDS DISPLAY WEIGHT UP TO:	HOW SOLD:	FULL CASE
CFV-7511	1-3/4" W x 1-1/2" H	18 oz.	Sheet Form	5000
CFV-6116	1-5/8" W x 1-1/4" H	14 oz.	Sheet Form	5000
RFV-0104	1-5/8" W x 1-1/8" H	16 oz.	On Roll	27,000
CFV-6494	7/8"W x 1-1/4"H	11 oz.	Sheet Form	10,000
SFV-6323	1-1/2"W x 1-9/16"H	12 oz.	Sheet Form	5000

MAGNETIC STRIP

WITH ADHESIVE BACKING*



*The adhesive is rubber-based with a protective peel coat resistant to water, detergent and alcohol. It is not recommended for use in contact with solvent such as aliphatic or aromatic hydrocarbons, ketones, esters or chlorinated hydrocarbons.

Other Thicknesses & Widths Available. Special Die Cutting Available
- Minimums Apply - Please Inquire.

.030 THICK - 200 FT. ROLLS WITH ADHESIVE

PART #	WIDTH	FT. PER
		CASE
MSA-1-0500	1/2"	1600 ft.
MSA-1-0750	3/4"	1200 ft.
MSA-1-1000	1"	800 ft.

.060 THICK - 100 FT. ROLLS WITH ADHESIVE

PART #	WIDTH	FT. PER
		CASE
MSA-2-0500	1/2"	800 ft.
MSA-2-0750	3/4"	600 ft.
MSA-2-1000	1"	400 ft.

.120 THICK - 100 FT. ROLLS WITH ADHESIVE

PART #	WIDTH	FT. PER
		CASE
MSA-3-0500	1/2"	600 ft.
MSA-3-0750	3/4"	400 ft.
MSA-3-1000	1"	300 ft.

DIGIMAG® MAGNETIC SHEET

.030" THICK - WITH GLOSS WHITE VINYL COVER

New & Improved

PRODUCT FEATURES:

- Flexible
- Die cut shear cut or punch
- Available in sheet or rolls
- Works with solvent inkjet printers, including Roland, Mutch, Epson, Oce, HP, AGFA, and Minaki - (all registered)
- Screen printable
- Indoor/outdoor use
- Available in matte finish (Please Inquire)

2 FT. x 50 FT. ROLLS

PART #
MAG2450

12" x 24" SHEETS

PART #
MAG1202

VINYL GLOSS COVER

MAGNETIC BACKING



MAGNACLAMP®

THE EFFICIENT WAY OF HANGING SIGNS, BANNERS AND DISPLAY MATERIAL

- Unaffected by frost
- Wash over, squeegee over
- Neat appearance - no unsightly residue
- Leaves no residue if removed

• LASTS FOR YEARS!

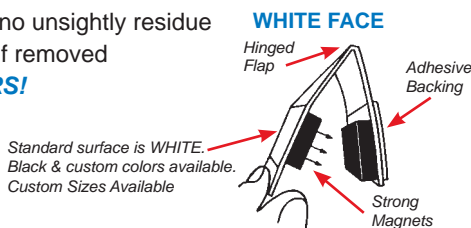

ADHESIVE BACK

PART #	LENGTH
MC-03-WH	3"
MC-06-WH	6"
MC-24-WH	24"
MC-36-WH	36"

MAGNACLAMP II®

THE HARD-SHELL MAGNACLAMP® FOR THE UPSCALE LOOK

- Attaches to a flat surface with permanent adhesive
- Integrated hinge opens to accept signage and clamp shut for a secure hold
- Black or white, 24" long with adhesive



PART #	LENGTH
MCHS-24-BK	24"
MCHS-24-WH	24"

NYLON PANEL FASTENERS

RATCHETING ACTION RIVETS



- For a 2-sided permanent assembly.
- Ideal for signage.
- Rigid design with gripper teeth.
- Provides an outstanding bond between panels.
- Ideal for use with materials such as corrugated cardboard, foam board, styrofoam, cork board or laminate.
- **Available in Natural or Black. Add BK at end of part # for Black.**

PART #	PANEL THICKNESS	HEAD DIA.	HOLE SIZE
RA-4250	7/32"	0.406"	9/32"
RA-4375	11/32"	0.406"	9/32"
RA-4750	1/2"	0.406"	9/32"
RA-4100	3/4"	0.406"	9/32"
RA-7250	7/32"	0.75"	9/32"
RA-7375	11/32"	0.75"	9/32"
RA-7750	1/2"	0.75"	9/32"
RA-7100	3/4"	0.75"	9/32"

TWO-PIECE REMOVABLE RIVETS

REACH, ROHS & LEED COMPLIANT



- For a 1-sided temporary or permanent assembly.
- Commonly used with dividers for retail shelving.
- Nylon rivets incorporates a slot in line with the pin so the pin can be **removed** by inserting a small screw driver or other sharp edge underneath the head of the pin.
- **Available in Natural or Black. Add BK at end of part # for Black.**

PART #	PANEL THICKNESS	HEAD DIA.	HOLE SIZE
RR-1886	1/16"	3/8"	.188"
RR-1882	1/8"	3/8"	.188"
*RR-2500	1/16"	7/16"	.250"
RR-2505	1/8"	7/16"	.250"
RR-2508	3/16"	7/16"	.250"

**In addition to working in a .250 round hole, part #RR-2500 will also fit the .210/.218 square hole found in the "Darling" type shelf commonly used in retail stores.*

NYLON SNAP RIVETS



- For a 1-sided temporary or permanent assembly.
- Ideal for electronic board assembly.
- Designed for assemblies requiring fast, economical, and **removable** fasteners.
- Can be installed without tools.
- Molded in high dielectric nylon.
- **Available in Black only**

PART #	PANEL THICKNESS	HEAD DIA.	HOLE SIZE
NSR-0010BK	.050/.100"	.254"	.123/.127"
NSR-1185BK	.400/.440"	.253"	.123/.127"
NSR-0012BK	.122/.160"	.249"	.127/.131"
NSR-0018BK	.100/.140"	.316"	.160/.164"
NSR-0020BK	.144/.188"	.317"	.160/.164"
NSR-1662BK	.050/.180"	.375"	.162/.166"
NSR-1573BK	.148/.188"	.315"	.162/.166"
NSR-1579BK	.290/.330"	.317"	.162/.166"
NSR-1600BK	.100/.250"	.278"	.165/.169"
NSR-2000BK	.230/.300"	.352"	.203/.207"
NSR-0030BK	.160/.200"	.350"	.205/.209"

TWO PIECE ANCHOR RIVETS

- For a 1-sided permanent assembly.
- Ideal for the building industry. Used predominantly in public areas such as schools & hospitals because the design prohibits easy removal.
- The pin "bites" into the wood as a metal stud.

- Versatile, inexpensive blind fasteners for solid or hollow materials, such as wood, concrete, plaster, metal, plastic, tile block and mortar.
- Fast installation. Simply insert the rivet into a pre-drilled hole and tap with a hammer. The drive pin expands and seats the rivet securely in place.
- **Available in White and Black. Add BK at end of part # for black.**



MUSHROOM HEAD - PLASTIC DRIVE PIN

PART #	PANEL THICKNESS	HEAD DIA.
APM-18075	3/4"	3/16"
APM-25075	3/4"	1/4"
APM-25100	1"	1/4"
APM-25150	1-1/2"	1/4"



MUSHROOM HEAD - STEEL (ZINC PLATED) DRIVE PIN

PART #	PANEL THICKNESS	HEAD DIA.
ASM-18075	3/4"	3/16"
ASM-18100	1"	3/16"
ASM-25075	3/4"	1/4"
ASM-25100	1"	1/4"
ASM-25150	1-1/2"	1/4"



TRUSS HEAD - PLASTIC DRIVE PIN

PART #	PANEL THICKNESS	HEAD DIA.
APT-18075	3/4"	3/16"
APT-25075	3/4"	1/4"
APT-25100	1"	1/4"
APT-25150	1-1/2"	1/4"



TRUSS HEAD - STEEL (ZINC PLATED) DRIVE PIN

PART #	PANEL THICKNESS	HEAD DIA.
AST-18075	3/4"	3/16"
AST-18100	1"	3/16"
AST-25075	3/4"	1/4"
AST-25100	1"	1/4"
AST-25150	1-1/2"	1/4"

OTHER SIZES AVAILABLE ON MOST ITEMS - PLEASE INQUIRE

CONNECTING BOLTS

REACH & ROHS COMPLIANT

STEEL (POZI-DRIVE) NICKEL PLATED

Heavy duty super strength for assembling cabinets, wall units, book-shelves & more. Nickel plated combination head (slot-pozi drive). Bolt is 14mm long.

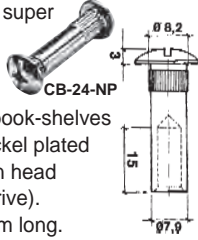

*Requires 8mm (Approx. 5/16") Bore

REACH & ROHS COMPLIANT

ALUMINUM (SLOT DRIVE)

- 13/32" head for 7/32" holes
- Two popular sizes work with most applications

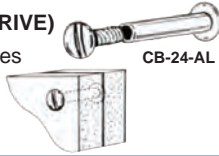

PLASTIC (SLOT DRIVE)

White

- Screw top w/steel bolt
- 1-1/2" closed - 2" open

200 Pcs. Per box

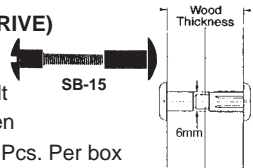

PLASTIC

PART #	OPENING		DIAMETER	
	MAXIMUM	MINIMUM	BARREL	HEAD
SB-15	1-15/16"	1-7/16"	5/16"	5/8"

ALUMINUM

PART #	OPENING		DIAMETER	
	MAXIMUM	MINIMUM	BARREL	HEAD
CB-24-AL	11/16"	1/2"	13/64"	3/8"
CB-75-AL	15/16"	3/4"	13/64"	3/8"

STEEL

PART #	OPENING		DIAMETER	
	MAXIMUM	MINIMUM	BARREL	HEAD
CB-24-NP	1-7/16"	7/8"	5/16"	1/2"
CB-31-NP	1-5/8"	1-3/16"	5/16"	1/2"
CB-37-NP	1-7/8"	1-3/8"	5/16"	1/2"

RATCHET ASSEMBLY POST & SCREW

- Polypropylene
- Simply press together these screws with serrated pins for fast and easy assembly
- Works with flat panels, punched papers, key cases, catalogs, etc.
- Not intended for applications requiring removable/reusable fasteners!
- Usable in corrosive environments
- Will not mark or mar most surfaces



PART #	COLOR	LENGTH
SP-250BK	Black	1/4"
SP-250WH	White	1/4"
SP-375BK	Black	3/8"
SP-375WH	White	3/8"
SP-500BK	Black	1/2"
SP-500WH	White	1/2"
SP-750BK	Black	3/4"
SP-750WH	White	3/4"

VIKING CLIP FASTENERS

- Polycarbonate
- Removable and reusable
- Quick push on assembly
- Screw off wing nut fastener to remove
- Extremely popular for sign and display construction

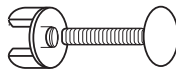

PART #	COLOR	HOLE SIZE	LENGTH	HEAD DIA.	CAPACITY
VKC-875-BK	Black	0.187	7/8" Fully Threaded	9/16"	3/4"
VKC-875-CL	Clear	0.187	7/8" Fully Threaded	9/16"	3/4"
VKC-1500-CL	Clear	0.187	1-1/2" L with a 5/8" Non-Threaded Shoulder	9/16"	1-3/8"

REACH & ROHS COMPLIANT

NATURAL NYLON ARROW CLIPS

- Molded natural nylon fasteners offer an inexpensive fast method to hand assemble metal, wood and plastic composition or any other thin gauge materials
- Reusable
- Specially designed body compresses through a pre-punched hole and springs back to shape, locking the assembled parts securely
- Provides a vibration, abrasion and corrosion resistant connection
- Electrically insulating

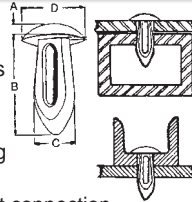

PART #	HOLE SIZE	PANEL THICKNESS RANGE	HEAD DIA. 'D'	HEAD HEIGHT 'A'	LENGTH 'B'	CLIP DIA. 'C'
AC-001	.182/.192	.062/.125	.360	.060	.400	.225
AC-003	.151/.161	.062/.125	.280	.040	.390	.196
AC-006	.182/.192	.310/.330	.370	.060	.540	0.225
AC-009	.250/.260	.125/.187	.484	.060	.575	.290
AC-015	.118/.122	.062/.125	.280	.060	.390	.150
AC-016	.250/.260	.360/.380	.610	.065	.810	0.286

OTHER SIZES AVAILABLE - PLEASE INQUIRE

REACH & ROHS COMPLIANT

PLASTIC FASTENERS

CANOE FASTENERS

CELCON • Black & White



PART #	COLOR	HOLE SIZE	SHAFT	HEAD DIA.	WORK THICKNESS
PF6-20BK	Black	3/16"	5/8"	13/32"	.228
PF6-20WH	White	3/16"	5/8"	13/32"	.228
PF6-31BK	Black	3/16"	5/8"	27/64"	.325
PF6-31WH	White	3/16"	5/8"	27/64"	.325

ROW BOAT FASTENERS

HDPE • Black & White

- Fits hole size 1/4"
- Fits work thickness 1/4"



PART #	COLOR
CF8-20BK	Black
CF8-20WH	White

TREE FASTENERS

NYLON • Black, White & Gray

Used for one-time applications & is purposely difficult to remove



PART #	COLOR	HOLE SIZE	SHAFT	HEAD DIA.	WORK THICKNESS
PF8-16BK	Black	1/4"	1/2"	11/16"	.180-.220
PF8-16WH	White	1/4"	1/2"	11/16"	.180-.220
PF8-20BK	Black	1/4"	5/8"	11/16"	.180-.380
PF8-20WH	White	1/4"	5/8"	11/16"	.180-.380
PF8-20GY	Gray	1/4"	5/8"	11/16"	.180-.380
PF8-24BK	Black	1/4"	3/4"	11/16"	.180-.570
PF8-28BK	Black	1/4"	7/8"	11/16"	.180-.700
PF8-32BK	Black	1/4"	1"	11/16"	.180-.820

HOOK & LOOP



VELCRO® brand woven nylon hook and loop tapes are manufactured by a precise and refined weaving process which ensures uniformity of dimensions and construction.

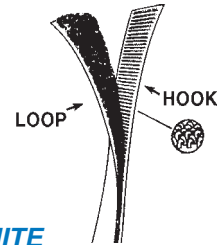
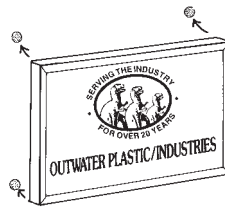
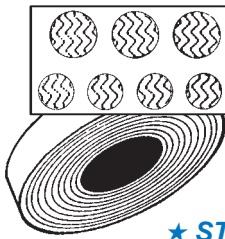

- ★ STOCK COLORS: BLACK (*BK) & (*WH) WHITE
- ★ SOLD IN FULL ROLLS ONLY

STANDARD GRADE

- ★ FOR INDOOR USE ONLY
- ★ RUBBER BASED ADHESIVE

FASTENING COINS

PART #	DESCRIPTION	PCS. PER ROLL
HKDT-12-*	1/2" Hook Coins	1440
LPDT-12-*	1/2" Loop Coins	1440
HKDT-58-*	5/8" Hook Coins	1200
LPDT-58-*	5/8" Loop Coins	1200
HKDT-34-*	3/4" Hook Coins	1028
LPDT-34-*	3/4" Loop Coins	1028
HKDT-78-*	7/8" Hook Coins	900
LPDT-78-*	7/8" Loop Coins	900

SMALL PACK

PART #	DESCRIPTION	PCS. PER ROLL
HC-063-*	5/8" Hook Coins	250
LC-063-*	5/8" Loop Coins	250
HC-088-*	7/8" Hook Coins	250
LC-088-*	7/8" Loop Coins	250

FASTENING TAPES

PART #	DESCRIPTION	ROLL LENGTH
HK-58-*	5/8" Hook	75'
LP-58-*	5/8" Loop	75'
HK-34-*	3/4" Hook	75'
LP-34-*	3/4" Loop	75'
HK-100-*	1" Hook	75'
LP-100-*	1" Loop	75'
HK-150-*	1-1/2" Hook	75'
LP-150-*	1-1/2" Loop	75'
HK-200-*	2" Hook	75'
LP-200-*	2" Loop	75'

PREMIUM GRADE

- ★ FOR INDOOR / OUTDOOR USE
- ★ ACRYLIC BASED ADHESIVE

FASTENING COINS

PART #	DESCRIPTION	PCS. PER ROLL
VCH-500-*	1/2" Velcro Hook	1440
VCL-500-*	1/2" Velcro Loop	1440
VCH-625-*	5/8" Velcro Hook	1200
VCL-625-*	5/8" Velcro Loop	1200
VCH-750-*	3/4" Velcro Hook	1028
VCL-750-*	3/4" Velcro Loop	1028
VCH-875-*	7/8" Velcro Hook	900
VCL-875-*	7/8" Velcro Loop	900

FASTENING TAPES

PART #	DESCRIPTION	ROLL LENGTH
VH-625-*	5/8" Velcro Hook	75'
VL-625-*	5/8" Velcro Loop	75'
VH-750-*	3/4" Velcro Hook	75'
VL-750-*	3/4" Velcro Loop	75'
VH-1000-*	1" Velcro Hook	75'
VL-1000-*	1" Velcro Loop	75'
VH-1500-*	1-1/2" Velcro Hook	75'
VL-1500-*	1-1/2" Velcro Loop	75'
VH-2000-*	2" Velcro Hook	75'
VL-2000-*	2" Velcro Loop	75'

NOTE: OTHER SIZES/LENGTHS & DIE-CUTTING AVAILABLE - PLEASE INQUIRE



BLACK and CLEAR - SOLD IN 50 YARD ROLLS



Dual Lock™ fasteners are continuous plastic (Polyolefin) strips with mushroom shaped stems. The interlocking design provides re-closable fastening for a wide range of applications.

Premium Performance Adhesive

Used to meet stringent fastening requirements in automotive, aircraft and electronic equipment applications, especially when temperature range is large (-20°F to 200°F). High Bonds can be achieved to a variety of surfaces, including paint, metal, and most plastics (except polypropylene and polyethylene).

General Purpose Adhesive

Used in dynamic and static applications where temperatures do not exceed 120°. When applied under normal conditions, high adhesive bonds can be achieved to a wide variety of clean dry surfaces including difficult surfaces like polyethylene and polypropylene.

Type 250 - Clear Only

- Stem pattern 250/in²
- Mates with itself for universal applications
- Mates with type 400 for higher strength applications
- Clarity provides color compatibility

Type 400 - Black Only

- Stem pattern 400/in²
- Mates with itself for high strength or flexible applications

BLACK GENERAL PURPOSE

(with a white rubber based adhesive)

TYPE	PART #	WIDTH
400	SJ-3541-0500	1/2"
400	SJ-3541-1000	1"

CLEAR PREMIUM PERFORMANCE

(with clear VHB acrylic adhesive)

TYPE	PART #	WIDTH
250	SJ-3560-0500	1/2"
250	SJ-3560-1000	1"

BLACK PREMIUM PERFORMANCE

(with white VHB acrylic adhesive)

TYPE	PART #	WIDTH
400	SJ-3551-0500	1/2"
400	SJ-3551-1000	1"

DOUBLE STICK FOAM TAPE WITH PROTECTIVE COVER

Our rubber-based Double Stick Foam Tape works well on most surfaces including: glass, metals, painted metal, paper, finished wood and plastics (including low surface energy polyethylene and polypropylene). It is not recommended for plasticized vinyl, materials contaminated with internal or surface lubricants and surfaces that are not clean and dry. Removing the tape is best accomplished by "thumbing" it off gradually. Solvents such as MEK, lacquer thinner and turpentine will degrade the adhesive, but are hazardous to work with and can damage the surface being cleaned as well.

POLYETHYLENE FOAM TAPE

ROLLS

- Available 1/32" or 1/16" thick
 - 1/2", 3/4" or 1" Wide
 - White (*WH) or Black (*BK)
 - 216 Ft. Rolls



1/32" THICK

PART #	WIDTH	ROLLS PER CASE
RFT1-0500*	1/2"	24
RFT1-0750*	3/4"	16
RFT1-1000*	1"	12

1/16" THICK

PART #	WIDTH	ROLLS PER CASE
RFT2-0500*	1/2"	24
RFT2-0750*	3/4"	16
RFT2-1000*	1"	12

DOTS

- Available 1/32" or 1/16" thick
 - 1/2", 3/4" or 1" Wide
 - White Only



1/32" THICK

PART #	DIA.
RFT1-120	1/2"
RFT1-340	3/4"
RFT1-100	1"

1/16" THICK

PART #	DIA.
RFT2-120	1/2"
RFT2-340	3/4"
RFT2-100	1"

CLEAR FILM TAPE

- .5mil polyester film with 2mil adhesive
- Rubber based adhesive not recommended for direct UV exposure applications
- Application temperature: 65°F-100°F
- Service temperature: -20°F-150°F
- Roll core: 3" Diameter -180 Ft.

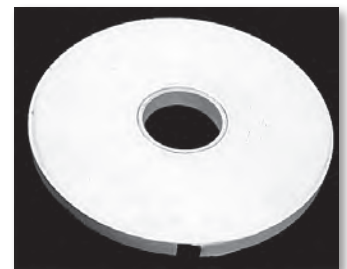

PART

DK-0500
DK-0750
DK-1000

CONNECTORS

CLIPMASTER - CLEAR LEXAN • FOR 3/16" PANELS

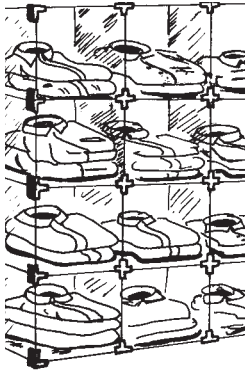

2-WAY

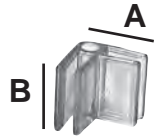

PART #	A	B
CM200	1"	1-1/4"

3-WAY

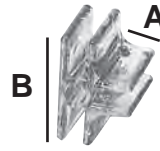

PART #	A	B
CM300	1/2"	1-1/2"

4-WAY

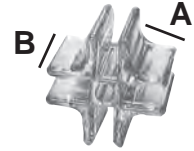

PART #	A	B
CM400	3/4"	1-1/4"

METAL CONNECTOR CLIPS WITH NYLON CONNECTION SCREW - FOR 3/16" MATERIAL

BRITE CHROME FINISH

2-WAY 90° MC-200



3-WAY 90° MC-300

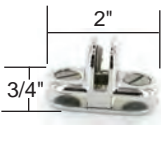

4-WAY 90° MC-400



HASP (w/o pin) MC-HASP



HINGE MC-HIN



PART #	DESCRIPTION
MC-200-BC	2-Way
MC-300-BC	3-Way
MC-400-BC	4-Way
MC-HIN-BC	Hinge w/Pin
MC-HASP-BC	Hasp w/o Pin

ALL METAL FURNITURE & DISPLAY CONNECTORS - FOR 3/16" TO 3/4" THICK PANELS

POLISHED ALUMINUM - BRASS, CHROME & BLACK

These connectors can be used with glass, marble, wood, rattan, plastic or metal panels for etageres, tables, displays, shelving, etc. Screws included.

2 WAY 180°

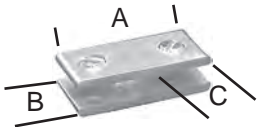

PANEL PART #	THICKNESS	A	B	C
206S-	3/16"-1/4"	1-7/8"	7/8"	13/16"

2 WAY 90°

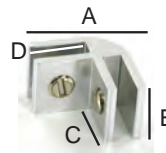

PANEL PART #	THICKNESS	A	B	C	D
206-	3/16"-1/4"	1-1/4"	1-1/4"	7/8"	13/16"
210-	5/16"-3/8"	1-5/8"	1-5/8"	1-1/2"	13/16"
212-	1/2"	1-7/8"	1-7/8"	1-1/2"	1"
219-	5/8"-3/4"	2-1/4"	2-1/4"	1-1/2"	1-1/8"

3-WAY T

PANEL PART #	THICKNESS	A	B	C	D
306T-	3/16"-1/4"	2"	1-1/8"	7/8"	13/16"
310T-	5/16"-3/8"	2-1/2"	1-5/8"	1-1/2"	13/16"
312T-	1/2"	3-1/2"	2-1/4"	1-1/2"	1"
319T-	5/8"-3/4"	3-1/2"	2-3/8"	1-1/2"	1-1/8"

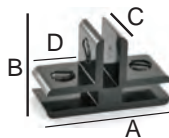

3-WAY Y

PANEL PART #	THICKNESS	A	B	C	D
306Y-	3/16"-1/4"	2"	1-3/4"	7/8"	13/16"
310Y-	5/16"-3/8"	2-1/4"	2"	1-1/2"	13/16"
312Y-	1/2"	2-3/4"	2-1/4"	1-1/2"	1"
319Y-	5/8"-3/4"	3-1/2"	3-1/8"	1-1/2"	1-1/8"

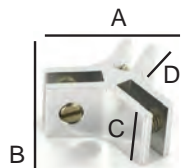

4 WAY

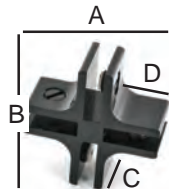

PANEL PART #	THICKNESS	A	B	C	D
406-	3/16"-1/4"	2"	2"	7/8"	13/16"
410-	5/16"-3/8"	2-3/8"	2-3/8"	1-1/2"	13/16"
412-	1/2"	3"	3"	1-1/2"	1"
419-	5/8"-3/4"	3-3/8"	3-3/8"	1-1/2"	1-1/8"

WALL MOUNT SHELF BRACKET



PANEL PART #	THICKNESS
106S-	3-1/6"-1/4"
110S-	5/16"-3/8"

CONNECTOR



PANEL PART #	THICKNESS
DC-R10-	5-1/6"-3/8"

WALL BRACKET



PANEL PART #	THICKNESS
DC-112U-	1/2"

CLEAR PLASTIC SPACER

Used as a support for table tops and shelving



PANEL PART #	THICKNESS
TF06	1/4"
TF10	3/8"
TF12	1/2"

REVOLVING DISPLAY BASES

ROUND

BLACK, WHITE or CLEAR - STYRENE

- Attractive and colorful.
- A variety of sizes and colors to choose from.
- Easily cemented to plastic or wood displays.
- Excellent way of displaying merchandise.



PART #	SIZE	COLOR	LOAD CAPACITY
S8-T44BK	4-1/4" Dia. x 9/16" Thick	Black	50 lbs.
S8-T44CL	4-1/4" Dia. x 9/16" Thick	Clear	50 lbs.
S8-T66BK	5-1/2" Dia. x 9/16" Thick	Black	75 lbs.
S8-T66CL	5-1/2" Dia. x 9/16" Thick	Clear	75 lbs.
S8-T99BK	9" Dia. x 1/2" Thick	Black	150 lbs.
S8-T99WH	9" Dia. x 1/2" Thick	White	150 lbs.
S8-T99CL	9" Dia. x 1/2" Thick	Clear	150 lbs.

ROUND SLOPING BASE

BLACK or CLEAR - STYRENE

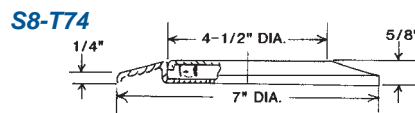

PART #	COLOR	LOAD CAPACITY
S8-T74BK	Black	100 lbs.

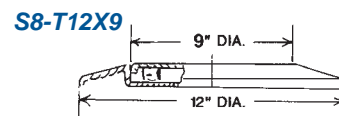

PART #	COLOR	LOAD CAPACITY
S8-T12X9BK	Black	100 lbs.
S8-T12X9CL	Clear	100 lbs.

ROUND LOW PROFILE

BLACK or WHITE - STYRENE

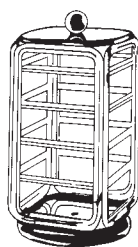
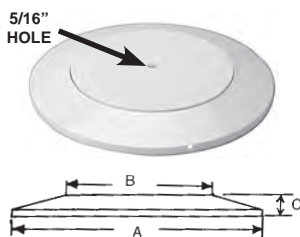

PART #	COLOR	OVERALL DIA. "A"	ROTATING DIA. "B"	UNIT HEIGHT "C"	LOAD CAPACITY
S8-L15BK	Black	14-1/2"	11"	3/4"	200+ lbs.
S8-L15WH	White	14-1/2"	11"	3/4"	200+ lbs.

LAZY SUSAN STEEL REVOLVING TURNTABLES

- Only 5/16" Thick (Can be recessed into surfaces for 1/8" thickness).
- Large, Full Ball Race For Maximum Stability & Smooth Gliding Rotation.
- 360° Interlock Prevents Separation.
- Electro Zinc Coated For Rust Resistance.
- Orders for less than the carton quantity are subject to a broken box fee.
- Made in the USA.

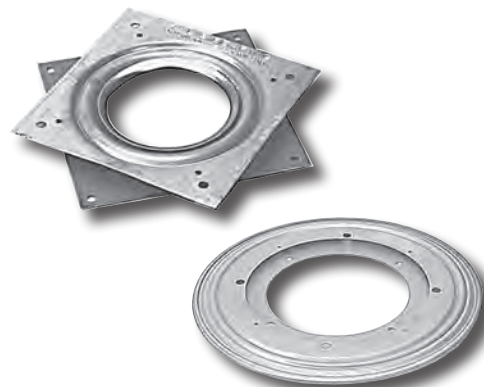

PART #	SIZE	CENTER HOLE DIA.	WEIGHT CAPACITY	APPROX. TOP DIA.	CARTON QUANTITY
S8-300C	3" Sq.	1-1/4"	200 lbs.	Up to 18"	100
S8-400C	4" Sq.	2-5/32"	300 lbs.	12" - 25"	100
S8-600C	6" Sq.	4-11/16"	500 lbs.	15" - 30"	100
S8-900C	9" Dia.	4-1/2"	700 lbs.	17" - 35"	25
S8-1200C	12" Dia.	6-9/32"	1000 lbs.	20" & Over	25

ALUMINUM REVOLVING TURNTABLES

SOLID ALUMINUM BALL BEARING SWIVELS CONTAIN LOCK SCREW FOR STATIONARY APPLICATION OR FOR SHIPPING



For Larger Applications

PART #	SIZE	WEIGHT CAPACITY
S8-1300C	13" Dia.	220 lbs.
S8-1600C	16" Dia.	250 lbs.
S8-1800C	17-3/8" Dia.	330 lbs.
S8-2400C	24" Dia.	700 lbs.

PART #	SIZE	WEIGHT CAPACITY	*APPROX. TOP DIA.
S8-1700C	17-3/8" Dia.	330 lbs.	24"

*Nonskid feet on upper & lower rail. Drill holes on upper & lower rail.

COMPACT BATTERY POWERED MOTORS

TOP PLATE VERSION

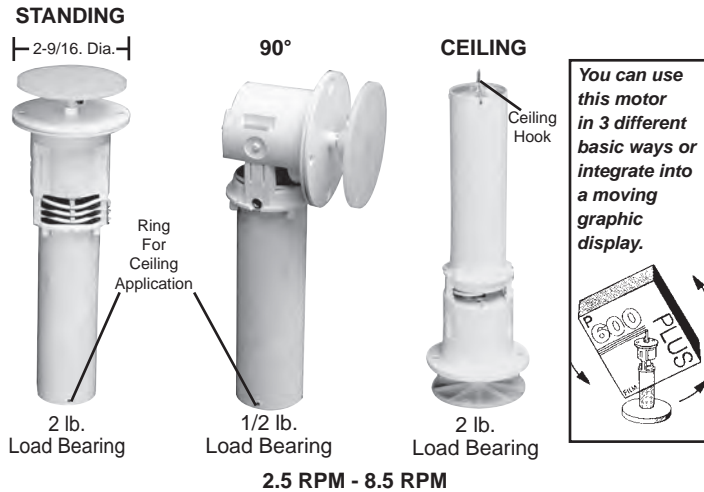

PART #	RPM'S	BATTERIES	OVERALL HEIGHT
BMP-1D	2.5	1 "D" CELL	5-1/4"
BMP-2D	5.5	2 "D" CELL	6-3/4"
BMP-3D	8.5	3 "D" CELL	10"

"S" VERSION

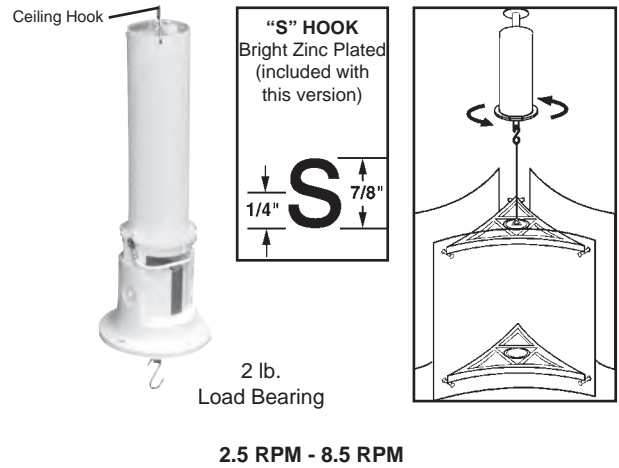

PART #	RPM'S	BATTERIES	OVERALL HEIGHT
BMH-1D	2.5	1 "D" CELL	5-1/4"
BMH-2D	5.5	2 "D" CELL	6-3/4"
BMH-3D	8.5	3 "D" CELL	10"

PENDULUM VERSION

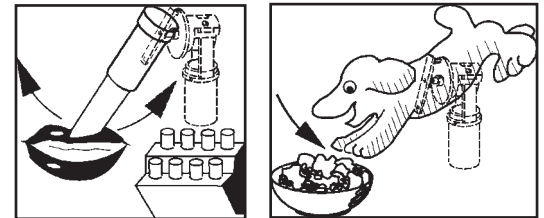
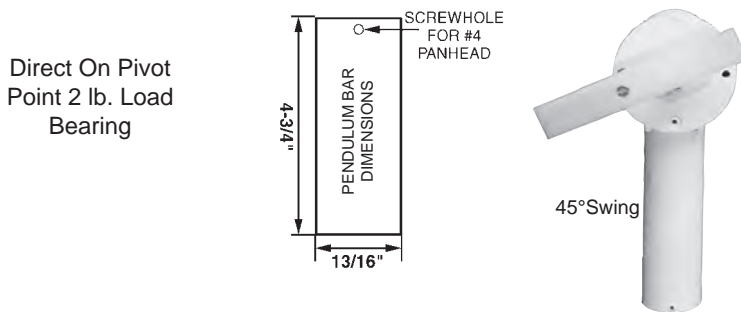

PART #	RPM'S	BATTERIES
BMS-1D	9	1 "D" CELL
BMS-2D	20	2 "D" CELL
BMS-3D	30	3 "D" CELL

MOTOR BASES

BATTERY POWERED

USES 2 "D" CELL BATTERIES (NOT INCLUDED)
COLOR - WHITE Overall Height - 2"

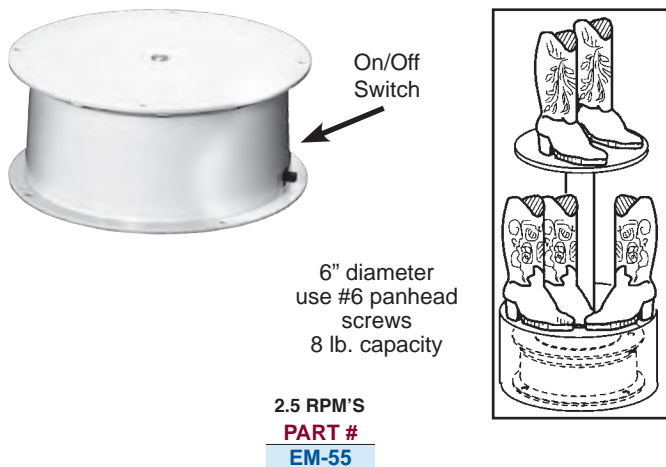

SLIMLINE BATTERY POWERED MOTOR



- Uses 2 AA batteries
- Load capacity: 800 grams
- 2-3/4" Wide x 4.7" Long x 1" High
- 2.5 RPM

PART #
SBM-2AA

ELECTRIC POWERED MOTOR BASES

Produced with UL Power Cord & Plug

6" Diameter - 10 Lb. Capacity - 2.5 RPMs

110V WHITE
use #6 panhead screws

6 Ft. Power Cord

PART #	OVERALL HEIGHT
EM-50	2"

9" Diameter - Medium Duty - 100 Lb. Capacity - 3 RPMs

Flange holes accept a 5/16" dia. screw - 8 FT. CORD

PART #	OVERALL HEIGHT
EM-150	4"

PART #	OVERALL HEIGHT
EM-150-L	4"

WITH COLLECTING RING TO WIRE LIGHTING
4 amp 480 watts

Metal 5" Diameter 22 Lb. Capacity - 2.5 RPMs

110V
- Flange holes accept a #4 panhead screw - 8 FT. CORD

PART #	OVERALL HEIGHT
EM-100	2-13/16"

PART #	OVERALL HEIGHT
EM-100-L	2-13/16"

WITH COLLECTING RING TO WIRE LIGHTING
4 amp 480 watts

15-3/4" Diameter - Heavy Duty - 220 Lb. Capacity - .80 RPMs

Flange holes accept a 5/16" dia. screw - 8 FT. CORD

PART #	OVERALL HEIGHT
EM-220	4-1/4"

PART #	OVERALL HEIGHT
EM-220-L	4-1/4"

WITH COLLECTING RING TO WIRE LIGHTING
4 amp 480 watts

COMPACT ELECTRIC POWERED MOTORS

Produced with UL Power Cord & Plug - 110V WITH 8 FT. CORD - WHITE ONLY (All flanges accept a #5 pan head screw)

TOP PLATE VERSION

FOR VERTICAL OR HORIZONTAL APPLICATIONS

8 Ft. Cord

"Screw holes for wall application"

2 lbs. Load Bearing (Central)

Top Plate accepts #6 pan screw

PART #	RPM'S
CEM-TP	2.5

PENDULUM VERSION

8 Ft. Cord

"Screw holes for wall application"

.50 lbs. Load Bearing (Pivot Point)

12 MOTIONS PER MINUTE

PART #
CEM-PD

PULLEY WHEEL VERSION

8 Ft. Cord

"Screw holes for wall application"

Load Bearing Can Lift Up To About 6 oz.

Tie knot in string to utilize up & down feature!

PART #	RPM'S
CEM-WHL	20

PREMIUM SLATWALL ACCESSORIES

• MAN MADE IN U.S.A. • FLAME POLISHED EDGES • .100 THICK ACRYLIC

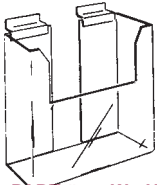

LITERATURE HOLDERS

CLEAR ACRYLIC - nominal 1/8" material
**WIDTH ALLOWS CLEARANCE FOR SIZES SHOWN

PACKED 12 PCS. PER CARTON *

PACKED 5 PCS. PER CARTON *

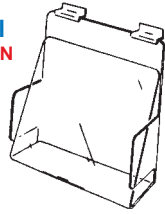

PART #	W x H
47SL-1	8-1/2" x 7"
47SL-2	4" x 7"
47SL-3	4-7/8" x 7"
47SL-5	8-1/2" x 9"

PART #	W x H
48SL-8	8-3/4" x 9"

For more Literature Holders, see pages 154-155.

SIGN HOLDERS

CLEAR ACRYLIC - nominal 1/8" material

PACKED 6 PCS. PER CARTON *

PART #	W x H
516-SL	5-1/2" x 7"
517-SL	7" x 5-1/2"
520-SL	8-1/2" x 11"
521-SL	11" x 8-1/2"
522-SL	11" x 14"
523-SL	14" x 11"

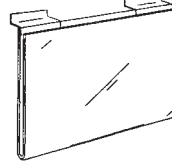

SHELVES

CLEAR ACRYLIC - nominal 1/8" material

Front Lip
Excepts
2" High
Sign Strip

PACKED 12 PER CARTON *
PART # WIDTH LENGTH

685-S	4"	9"
-------	----	----

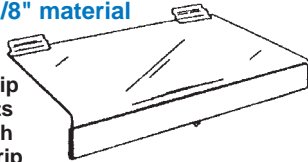

CLEAR ACRYLIC - nominal 1/8" material

PACKED 12 PER CARTON *

PART #	WIDTH	HEIGHT
662-SL	4"	16"
663-SL	4"	20"
664-SL	4"	24"
665-SL	6"	16"



CLEAR ACRYLIC - 45° SLANT

PACKED 6 PER CARTON *

PART #	DEPTH	WIDTH
855-SL	12"	12"
856-SL	12"	16"
857-SL	12"	18"

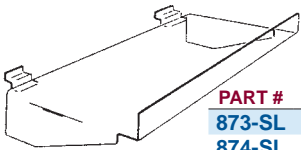
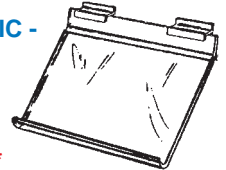

CLEAR ACRYLIC - 3/16" THICK
WITH HEAT BENT GUSSETS
FOR EXTRA SUPPORT

PART #	WIDTH	LENGTH
873-SL	8"	24"
874-SL	8"	36"
878-SL	10"	24"
879-SL	10"	36"

PACKED 6 PER CARTON *

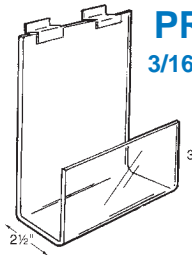

PREMIUM SHELF

3/16" THICK CLEAR ACRYLIC BOOK SHELF

PART #	W x H
705-SL	5-7/8" x 8"
711-SL	11-7/8" x 8"
715-SL	15-7/8" x 8"

PACKED 6 PCS. PER CARTON *

PREMIUM FREE STANDING

• MAN MADE IN U.S.A. • FLAME POLISHED EDGES • .100 THICK ACRYLIC

LITERATURE HOLDERS

CLEAR ACRYLIC - nominal 1/8" material
** WIDTH ALLOWS CLEARANCE FOR SIZES SHOWN

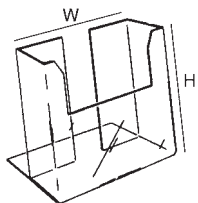

FREE
STANDING
HOLDER

PACKED 12 PCS. PER CARTON*

PART #	** W x H
47FS-2	4" x 7"
47FS-3	4-7/8" x 7"
47FS-5	8-1/2" x 9"

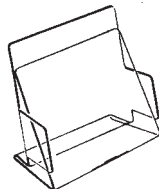

FREE
STANDING
TENSION
HOLDER

PACKED 5 PCS. PER CARTON*

PART #	** W x H
48FS-8	8-3/4" x 9"

FREE STANDING SIGNS

CLEAR ACRYLIC - nominal 1/8" material

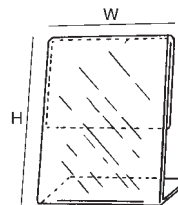

PACKED 12 PCS. PER CARTON*

PART #	W x H
SH-12A	7" x 5-1/2"
SH-13A	5-1/2" x 7"
SH-14A	11" x 7"
SH-15A	7" x 11"
SH-16A	11" x 8-1/2"
SH-17A	8-1/2" x 11"

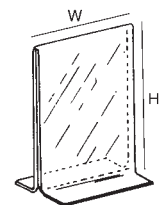

PACKED 12 PCS. PER CARTON*

PART #	W x H
SH-12C	7" x 5-1/2"
SH-13C	5-1/2" x 7"
SH-14C	11" x 7"
SH-15C	7" x 11"
SH-16C	11" x 8-1/2"
SH-17C	8-1/2" x 11"

PREMIUM SLATWALL SCREW MOUNT ACCESSORIES

• MAN MADE IN U.S.A • FLAME POLISHED EDGES • .100 THICK ACRYLIC

LITERATURE HOLDERS

CLEAR ACRYLIC: nominal 1/8" material

** WIDTH ALLOWS CLEARANCE FOR SIZES SHOWN

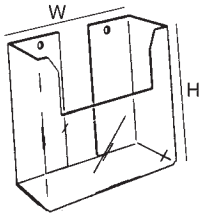

SCREW MOUNT HOLDER

PACKED 12 PCS.
PER CARTON *

USE #8 PANHEAD
SCREWS

PART #	** W x H
47SM-1	3-1/2" x 7"
47SM-2	4" x 7"
47SM-3	4-7/8" x 7"
47SM-5	8-1/2" x 9"

SCREW MOUNT TENSION LITERATURE HOLDER

USE #8 PANHEAD SCREWS

PACKED 5 PCS.
PER CARTON *

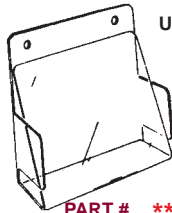

PART #	**W x H
48SM-8	8-3/4" x 9"

For more Literature Holders, see pages 154-155.

SIGN HOLDERS

CLEAR ACRYLIC: nominal 1/8" material

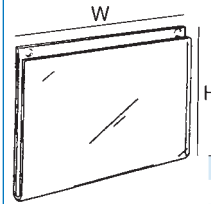

SCREW MOUNT

PACKED 6 PCS.
PER CARTON *

USE #8 PANHEAD
SCREWS

PART #	W x H
506-SM	5-1/2" x 7"
507-SM	7" x 5-1/2"
509-SM	11" x 7"
510-SM	8-1/2" x 11"
511-SM	11" x 8-1/2"
512-SM	11" x 14"
513-SM	14" x 11"

ECONOMY SLATWALL

CLEAR ACRYLIC: 4 FT. LENGTHS
THICKNESS - 3/32"

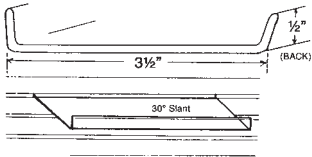

PART #
DM350-CL

CLEAR ACRYLIC: 4 FT. LENGTHS

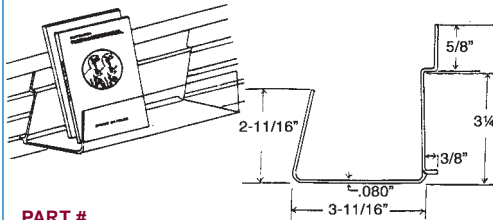

PART #
587-CL

STYRENE -
1/8" x 4" x 10"



Holds 1-1/4" Ticket

PART #	COLOR
821CL	Clear

STYRENE -
1/8" x 4" x 10"



PART #	COLOR
820CL	Clear



2-1/2" Deep Front Ticket Holds
Up To 1/8" Thick Material

BLACK & CLEAR
4 FT. LENGTHS

PART #	COLOR
DM351-CL	Clear
DM351-BK	Black

GRIDWALL / ACCESSORIES

STYRENE - CLEAR ONLY

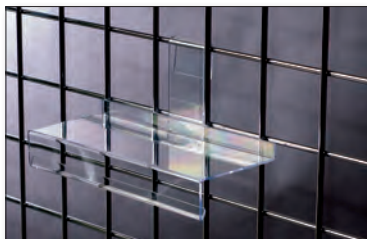

4" x 10" Shelf
Holds 1-1/4" Ticket

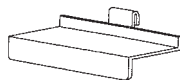

FEATURE SHELF

PART #	FINISH
GW821CL	Clear Styrene

STYRENE - CLEAR ONLY

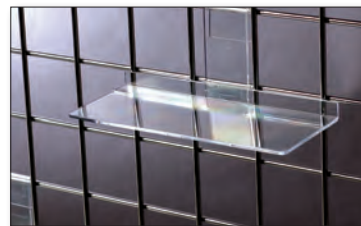

4" x 10" Shelf



STANDARD SHOE SHELF

PART #	FINISH
GW820CL	Clear Styrene

CLASSIC STYLE ACRYLICS EASEL

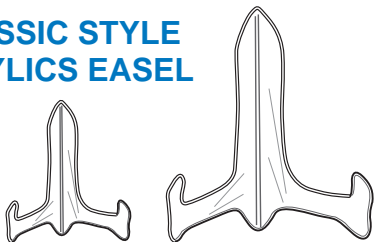

PART #	DIMENSIONS
AA-CE-1	3"H
AA-CE-2	4-1/2"H
AA-CE-3	6"H
AA-CE-4	7-1/2"H
AA-CE-5	9"H

HEAVY DUTY ACRYLIC EASEL

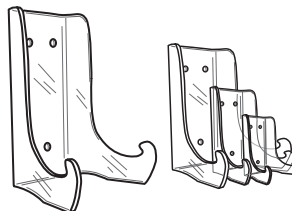

PART #	HOLDS PLATES	DIMENSIONS
AA-HE-1	3" - 5"	3-3/8"W x 2-1/4"D x 4-1/2"H
AA-HE-2	5" - 8"	4"W x 3-1/4"D x 6-1/2"H
AA-HE-3	7" - 10"	6-3/8"W x 4-1/4"D x 7-1/2"H
AA-HE-4	10" - 12"	6-3/4"W x 5-1/4"D x 9"H
AA-HE-5	12" - 15"	8-1/2"W x 6-3/4"D x 12"H
AA-HE-6	15" - 20"	10-1/4"W x 8-3/4"D x 15"H
AA-HE-7	20" - 24"	14"W x 10-1/4"D x 18"H

DEEP EASELS

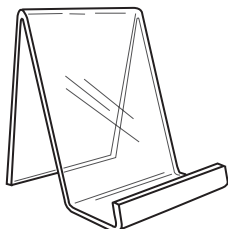

3" opening for thick boxed items such as games or computer software.

PART #	DIMENSIONS
AA-DE-1	3-1/2"W x 5"H
AA-DE-2	5-1/2"W x 6"H
AA-DE-3	7-1/2"W x 8"H

BOOK EASELS

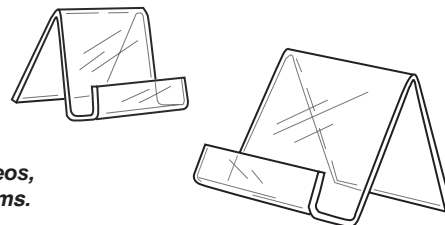

For displaying books, videos, software and other flat items.

PART #	DIMENSIONS
AA-BE-1	3-1/2"W x 1"D x 4"H
AA-BE-2	5-1/2"W x 1"D x 6"H
AA-BE-3	7-1/2"W x 1-3/4"D x 8"H
AA-BE-4	9"W x 1-3/4"D x 11"H

CELL PHONE EASEL

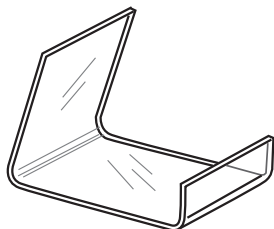

Perfect for small electronics such as cell phones, portable music players, etc.

PART #	DIMENSIONS
AA-CP-1	2"W x 3"D x 2"H

PHONE PEDESTALS

Perfect for small electronics such as cell phones, portable music players, etc.

PART #	DIMENSIONS
AA-CP-2	4"H
AA-CP-3	5"H
AA-CP-4	6"H
AA-CP-S1	Set of 3

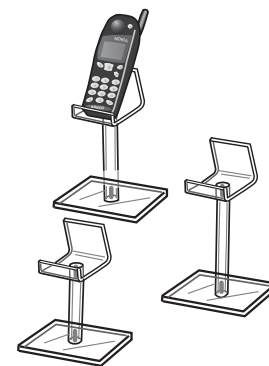

SLATWALL BINS

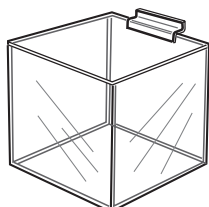

Perfect for holding merchandise of various sizes on slatwall, made from heavy 3/16" acrylic.

PART #	DIMENSIONS
AA-TD-14-SL	4" Square
AA-TD-15-SL	6" Square
AA-TD-16-SL	8" Square
AA-TD-17-SL	10" Square
AA-TD-18-SL	12" Square

5 PEDESTAL GROUPING

Pedestals:

2 ea. - 3"H 2 ea. - 6"H 1 ea. - 9"H



PART #	DIMENSIONS
AA-CP-6	12" Semi-Circle

SQUARE CUBES

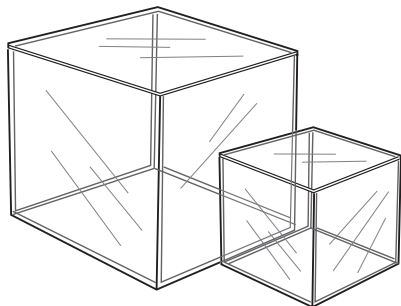

- Five sided acrylic cubes to cover and protect.
- Keep your collectibles free of dust and damage under our display boxes.
- Several sizes are available in either economy 1/8" acrylic or a thicker 3/16" thick acrylic.

1/8" Thick Acrylic Square Cube

PART #	DIMENSIONS
AAD-SC-1	4"W x 4"D x 4"H
AAD-SC-2	6"W x 6"D x 6"H
AAD-SC-3	8"W x 8"D x 8"H
AAD-SC-4	10"W x 10"D x 10"H

3/16" Thick Acrylic Square Cube

PART #	DIMENSIONS
AAD-SC-1T	4"W x 4"D x 4"H
AAD-SC-2T	6"W x 6"D x 6"H
AAD-SC-3T	8"W x 8"D x 8"H
AAD-SC-4T	10"W x 10"D x 10"H
AAD-SC-5T	12"W x 12"D x 12"H
AAD-SC-6T	14"W x 14"D x 14"H
AAD-SC-7T	15"W x 15"D x 15"H
AAD-SC-8T	16"W x 16"D x 16"H
AAD-SC-9T	18"W x 18"D x 18"H

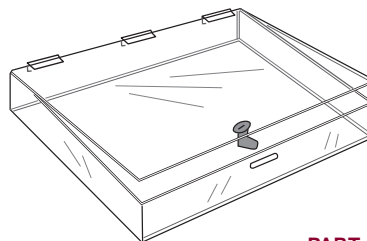

FLAT ACRYLIC SHOWCASE

Perfect for jewelry, knives, trading cards, etc.

PART #	DIMENSIONS
AAD-AS-1	24"W x 3"D x 18"H With Locking Top

LOCKING ACRYLIC SHOWCASES

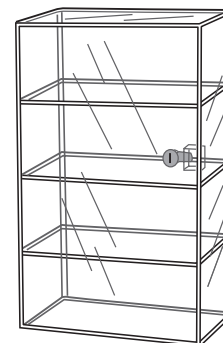

PART #	DIMENSIONS
AAD-AS-2	13"W x 7-1/2"D x 21"H With 4 Flat Shelves

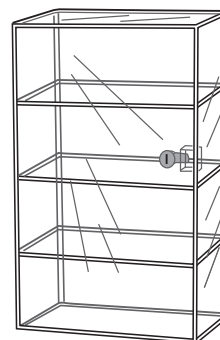

LARGE LOCKING ACRYLIC SHOWCASES

PART #	DIMENSIONS
AAD-AS-3	15-1/2"W x 8-1/2"D x 24"H With 4 Flat Shelves

LOCKING DOUBLE DOOR SHOWCASES

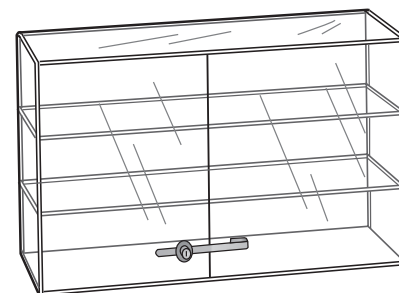

PART #	DIMENSIONS
AAD-AS-4	21"W x 7-1/2"D x 13"H With 3 Flat Shelves

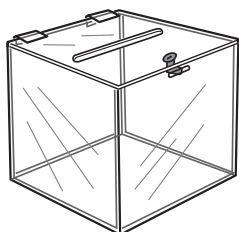

LOCKING BALLOT BOX

Locking clear acrylic ballot box. Perfect for raffles & drawings. Comes with key lock

PART #	DIMENSIONS
AAD-BB-1	8"W x 8"D x 8"H
AAD-BB-2	10"W x 10"D x 10"H

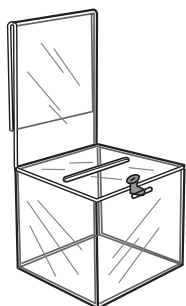

LOCKING BALLOT BOX WITH SIGN HOLDER

Easily display contest rules or your company's advertising information in attached sign holder.

PART #	DIMENSIONS
AAD-BB-3	8-1/2"W x 8-1/2"D x 8-1/2"H Box With 8-1/2"W x 11"H Sign Holder

ACRYLIC PRODUCTS

1/8" CLEAR ACRYLIC RISERS

AAD-AR1-S2

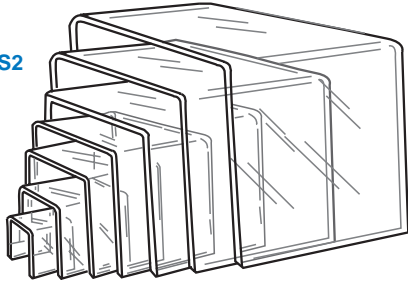

AAD-AR1-S3

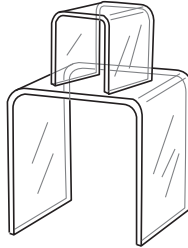

AAD-AR1-S1

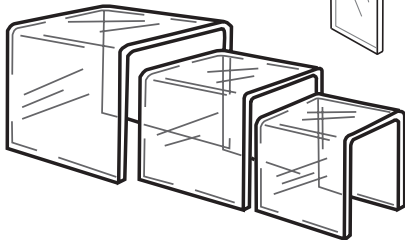

PART #	DIMENSIONS
AAD-AR1-1	2"W x 2"D x 2"H
AAD-AR1-2	3"W x 3"D x 3"H
AAD-AR1-3	4"W x 4"D x 4"H
AAD-AR1-4	5"W x 5"D x 5"H
AAD-AR1-5	6"W x 6"D x 6"H
AAD-AR1-6	7"W x 7"D x 7"H
AAD-AR1-7	8"W x 8"D x 8"H

SETS

PART #	DIMENSIONS
AAD-AR1-S1	Set of 3 Acrylic Risers: 3"W x 3"D x 3"H, 4"W x 4"D x 4"H, 5"W x 5"D x 5"H
	Set of 7 Acrylic Risers: 2"W x 2"D x 2"H, 3"W x 3"D x 3"H, 4"W x 4"D x 4"H, 5"W x 5"D x 5"H, 6"W x 6"D x 6"H, 7"W x 7"D x 7"H, 8"W x 8"D x 8"H
	Set of 3 Acrylic Risers: 2"W x 2"D x 2"H, 3"W x 3"D x 3"H, 4"W x 4"D x 4"H
AAD-AR1-S2	
AAD-AR1-S3	

3/16" CLEAR ACRYLIC RISERS

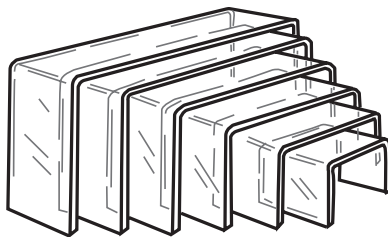

AAD-AR2-S1

For medium weight items.

PART #	DIMENSIONS
AAD-AR2-1	3-3/4"W x 4"D x 3-1/4"H
AAD-AR2-2	4-1/2"W x 4"D x 3-3/4"H
AAD-AR2-3	5-1/4"W x 4"D x 4-1/4"H
AAD-AR2-4	6"W x 4"D x 4-3/4"H
AAD-AR2-5	6-3/4"W x 4"D x 5-1/4"H
AAD-AR2-6	7-1/2"W x 4"D x 5-3/4"H

SET

PART #	DIMENSIONS
AAD-AR2-S1	Set of 6 Acrylic Risers: 3-3/4"W x 4"D x 3-1/4"H, 4-1/2"W x 4"D x 3-3/4"H, 5-1/4"W x 4"D x 4-1/4"H, 6"W x 4"D x 4-3/4"H, 6-3/4"W x 4"D x 5-1/4"H, 7-1/2"W x 4"D x 5-3/4"H

1/4" CLEAR ACRYLIC VARIETY RISERS

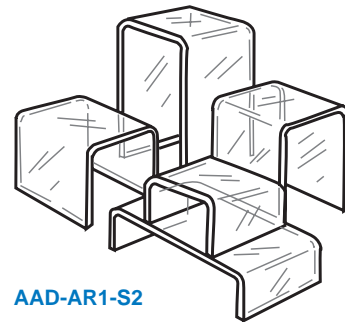

AAD-AR1-S2

PART #	DIMENSIONS
AAD-AR3-1	6"W x 6"D x 3"H
AAD-AR3-2	6"W x 6"D x 9"H
AAD-AR3-3	6"W x 6"D x 12"H
AAD-AR3-4	12"W x 6"D x 3"H
AAD-AR3-5	6"W x 6"D x 6"H

SET

PART #	DIMENSIONS
AAD-AR3-S1	Set of 5 Acrylic Risers: 6"W x 6"D x 3"H, 6"W x 6"D x 9"H, 6"W x 6"D x 12"H, 12"W x 6"D x 3"H, 6"W x 6"D x 6"H

SHELF STAIRWAY

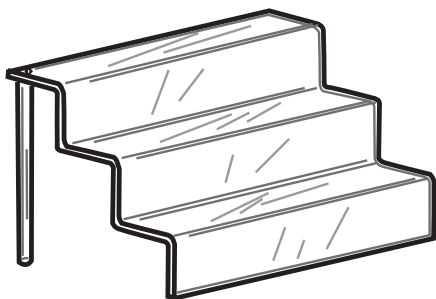

2" Deep Shelf Stairway

PART #	DIMENSIONS
AAD-SR-1	4"W x 2"D x 6-3/4"H
AAD-SR-2	6"W x 2"D x 6-3/4"H
AAD-SR-3	12"W x 2"D x 6-3/4"H

3" Deep Shelf Stairway

PART #	DIMENSIONS
AAD-SR-4	6"W x 3"D x 9-3/4"H
AAD-SR-5	12"W x 3"D x 9-3/4"H
AAD-SR-6	18"W x 3"D x 9-3/4"H

4" Deep Shelf Stairway

PART #	DIMENSIONS
AAD-SR-7	12"W x 4"D x 12-1/2"H
AAD-SR-8	18"W x 4"D x 12-1/2"H

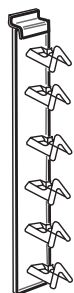

EYEWEAR DISPLAYS

PART #	DIMENSIONS
AAD-EW-6	23-1/4"H- Holds 6 pair (Slatwall)



COUNTERTOP MIRRORS

PART #	DIMENSIONS
AAD-DM-2	9"W x 12"H

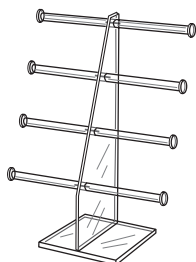

TIERED JEWELRY DISPLAY

Four tiered acrylic bracelet display.

PART #	DIMENSIONS
AAD-NT-4	10-1/2"W x 13-1/2"H

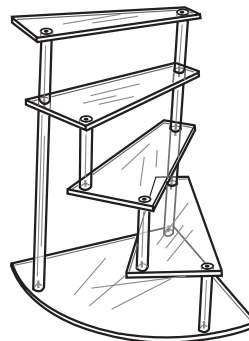

SPIRAL STAIRWAY

PART #	DIMENSIONS
AAD-SR-9	4 x 12" Shelves, 17-1/4"H

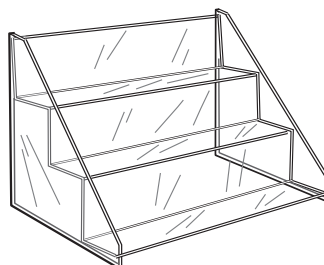

REVERSIBLE 3 TIER COUNTER DISPLAY

Can be used with 2"D shelves or reversed for 3"D shelves.

PART #	DIMENSIONS
AAD-SR-10	15"W x 7"D x 10"H



ACRYLIC SLATWALL & GRIDWALL MIRROR

Unique design can be hung onto either slatwall or gridwall.

PART #	DIMENSIONS
AAD-DM-1	9"W x 12"H

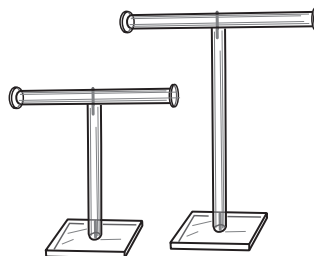

NECKLACE T-BARS

PART #	ROD SIZE	DIMENSIONS
AAD-NT-1	3/4" dia.	11-1/2"W x 8"H
AAD-NT-2	1" dia.	15-1/2"W x 15"H
AAD-NT-3	1" dia.	15-1/2"W x 18"H

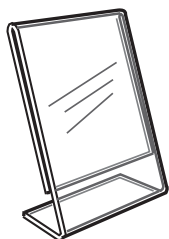

SLANTBACK COUNTERTOP SIGN HOLDERS

Standard sign holders have polished edges and are made from 1/8" acrylic.
Economy sign holders feature unpolished edges and thinner acrylic.

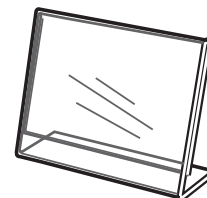

VERTICAL

PART #	DIMENSIONS
AAD-SH-1V-SB	2"W x 3-1/2"H
AAD-SH-2V-SB	2-1/2"W x 3-1/2" H
AAD-SH-3V-SB	3-1/2"W x 5-1/2"H
AAD-SH-4V-SB	4"W x 6"H
AAD-SH-5V-SB	5"W x 7"H
AAD-SH-6V-SB	5-1/2"W x 7"H
AAD-SH-7V-SB	7"W x 11"H
AAD-SH-8V-SB	8"W x 10"H
AAD-SH-9V-SB	8-1/2"W x 11"H

HORIZONTAL

PART #	DIMENSIONS
AAD-SH-1H-SB	3-1/2"W x 2"D
AAD-SH-2H-SB	3-1/2"W x 2-1/2"H
AAD-SH-3H-SB	5-1/2"W x 3-1/2"H
AAD-SH-4H-SB	6"W x 4"H
AAD-SH-5H-SB	7"W x 5"H
AAD-SH-6H-SB	7"W x 5-1/2"H
AAD-SH-7H-SB	11"W x 7"H
AAD-SH-8H-SB	10"W x 8"H
AAD-SH-9H-SB	11"W x 8-1/2"H

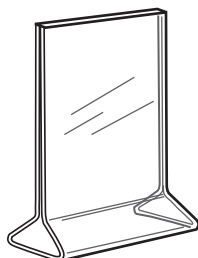

TOP LOADING SIGN HOLDERS

Standard sign holders have polished edges and are made from 1/8" acrylic.
Economy sign holders feature unpolished edges and thinner acrylic.

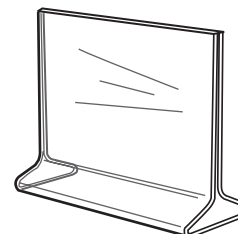

VERTICAL

PART #	DIMENSIONS
AAD-SH-3V-TL	3-1/2"W x 5-1/2"H
AAD-SH-6V-TL	5-1/2"W x 7"H
AAD-SH-7V-TL	7"W x 11"H
AAD-SH-9V-TL	8-1/2"W x 11"H
AAD-SH-10V-TL	11"W x 14"H

HORIZONTAL

PART #	DIMENSIONS
AAD-SH-3H-TL	5-1/2"W x 3-1/2"H
AAD-SH-6H-TL	7"W x 5-1/2"H
AAD-SH-7H-TL	11"W x 7"H
AAD-SH-9H-TL	11"W x 8-1/2"H
AAD-SH-10H-TL	14"W x 11"H

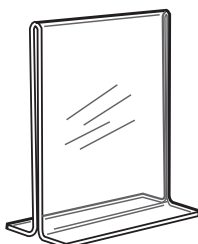

BOTTOM LOADING SIGN HOLDERS

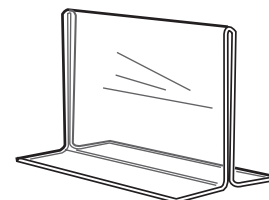

VERTICAL

PART #	DIMENSIONS
AAD-SH-3V-BL	3-1/2"W x 5-1/2"H
AAD-SH-5V-BL	5"W x 7"H
AAD-SH-6V-BL	5-1/2"W x 7"H
AAD-SH-7V-BL	7"W x 11"H
AAD-SH-9V-BL	8-1/2"W x 11"H
AAD-SH-10V-BL	11"W x 14"H
AAD-SH-11V-BL	11"W x 17"H

HORIZONTAL

PART #	DIMENSIONS
AAD-SH-3H-BL	5-1/2"W x 3-1/2"H
AAD-SH-5H-BL	7"W x 5"H
AAD-SH-6H-BL	7"W x 5-1/2"H
AAD-SH-7H-BL	11"W x 7"H
AAD-SH-9H-BL	11"W x 8-1/2"H
AAD-SH-10H-BL	14"W x 11"H
AAD-SH-11H-BL	17"W x 11"H

ACRYLIC PRODUCTS

SIGN HOLDER w/ BROCHURE POCKET

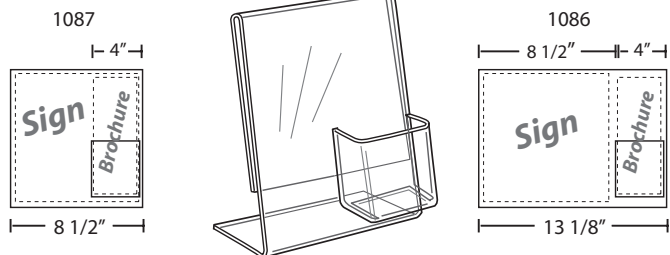

Increase effectiveness by adding brochure a pocket to any brochure or sign holder. Pocket accommodate a 4"W x 9"H Tri-Fold Brochure

PART #	DIMENSIONS
AAD-SH-BP1-SB	13-1/8"W x 11"H
AAD-SH-BP2-SB	8-1/2"W x 11"H

LARGE HANGING SIGN HOLDERS

Great for posters!

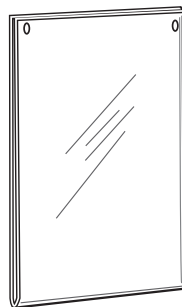

PART #	DIMENSIONS
AAD-SH-12V-SM	14" x 22"
AAD-SH-13V-SM	22" x 28"

COUNTERTOP EYEWEAR DISPLAYS

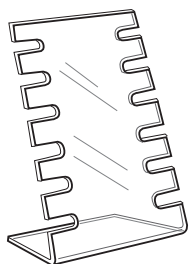

PART #	DIMENSIONS
AAD-EW-5	16" H- Holds 6 pair

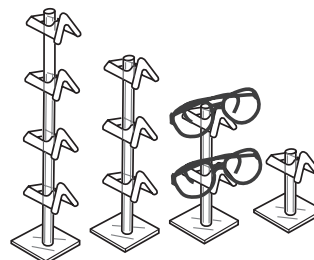

FREE STANDING EYEWEAR POSTS

PART #	DIMENSIONS
AAD-EW-1	3"H- Holds 1 pair
AAD-EW-2	6"H- Holds 2 pair
AAD-EW-3	9"H- Holds 3 pair
AAD-EW-4	12"H- Holds 4 pair

WALLMOUNT SIGN HOLDERS



VERTICAL

PART #	DIMENSIONS
AAD-SH-1V-SM	2"W x 3-1/2"H
AAD-SH-3V-SM	3-1/2"W x 5-1/2"H
AAD-SH-6V-SM	5-1/2"W x 7"H
AAD-SH-7V-SM	7"W x 11"H
AAD-SH-9V-SM	8-1/2"W x 11"H
AAD-SH-10V-SM	11"W x 14"H
AAD-SH-11V-SM	11"W x 17"H

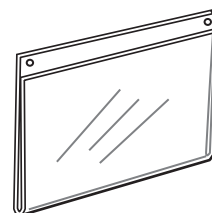

HORIZONTAL

PART #	DIMENSIONS
AAD-SH-1H-SM	3-1/2"W x 2"H
AAD-SH-3H-SM	5-1/2"W x 3-1/2"H
AAD-SH-6H-SM	7"W x 5-1/2"H
AAD-SH-7H-SM	11"W x 7"H
AAD-SH-9H-SM	11"W x 8-1/2"H
AAD-SH-10H-SM	14"W x 11"H
AAD-SH-11H-SM	17"W x 11"H

3 TIER BROCHURES HOLDERS

New improved design.
Can be used on counter or wall mounted.

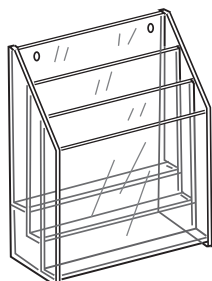

PART #	POCKETS	DIMENSIONS
AAD-BH1-1	3	4"W x 9"H
AAD-BH1-2	6	4"W x 9"H
AAD-BH1-3	9	4"W x 9"H
AAD-BH1-4	12	4"W x 9"H
AAD-BH2-1	3	8-1/2"W x 11"H
AAD-BH2-2	6	8-1/2"W x 11"H
AAD-BH2-3	9	8-1/2"W x 11"H

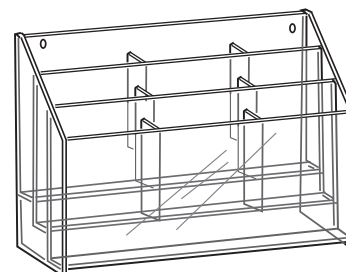

ACRYLIC PRODUCTS

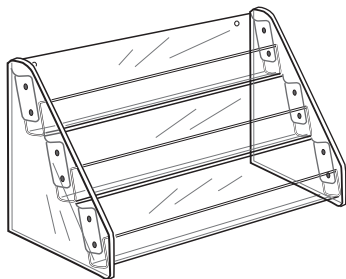

TILT BACK CARD RACKS

- Each shelf is 21"W x 1-3/4"D x 4"H inside.
- Shipped knocked down for easy assembly.
- Countertop or Wallmount.

PART #	DIMENSIONS
AAD-CD-2T	21"W x 8"D x 13-1/2"H

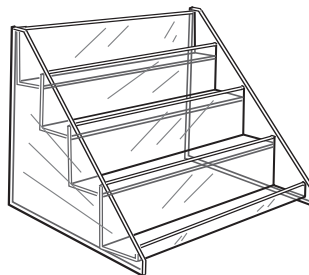

4 TILT BACK CARD RACKS

- Each shelf is 21"W x 1-3/4"D x 4"H inside.
- Shipped knocked down for easy assembly.
- Countertop or Wallmount.

PART #	DIMENSIONS
AAD-CD-4T	21"W x 10-1/2"D x 17-1/2"H

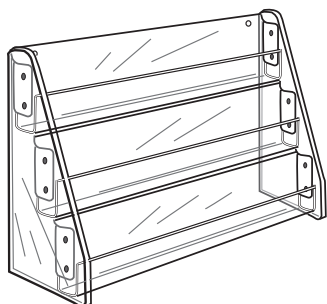

3 TIER CARD & VIDEO RACK

- Each shelf is 21"W x 1-3/4"D x 4"D inside.
- Shipped knocked down for easy assembly.
- Countertop or Wallmount.

PART #	DIMENSIONS
AAD-CD-1T	21"W x 6"D x 14-1/2"H

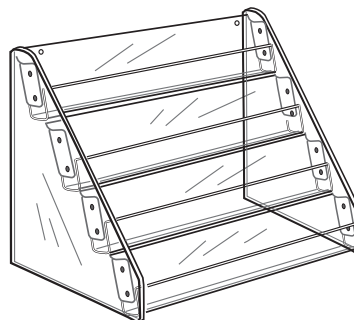

4 TIER DISPLAY

- 1/4" thick acrylic with a 3/4" front lip.
- For wallets, leather goods, etc.

PART #	DIMENSIONS
AAD-CD-3T	15-1/2"W x 11"D x 12-3/4"H

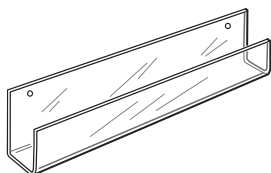

WALLMOUNT CARD RACKS

These racks slope downward and are perfect for displaying greeting cards, books, videos and software.

PART #	DIMENSIONS
AAD-CD-1-WM	11-3/4"W- Open End
AAD-CD-2-WM	23-3/4"W- Open End
AAD-CD-3-WM	35-3/4"W- Open End
AAD-CD-4-WM	47-3/4"W- Open End

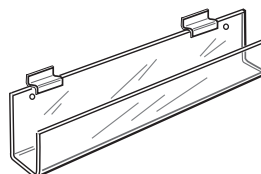

SLATWALL CARD RACKS

PART #	DIMENSIONS
AAD-CD-1-SL	11-3/4"W- Open End
AAD-CD-2-SL	23-3/4"W- Open End
AAD-CD-3-SL	35-3/4"W- Open End
AAD-CD-4-SL	47-3/4"W- Open End

SINGLE AND MULTIPLE TRAY DISPLAYS

- Ideal for displaying gems, beads, and other small items in a compact space.
- Order trays individually or as multi bin racks. Bins may be mixed and matched to make the perfect display for you items.
- For tiered displays, specify the trays that would best suit your needs.

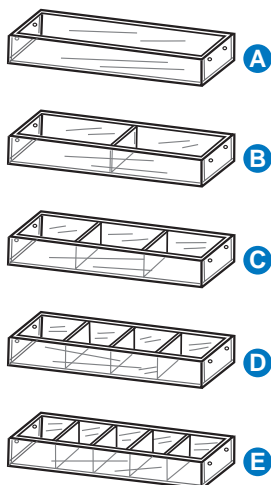

GRIDWALL

	PART #	COMPARTMENTS	DIMENSIONS
A	AAD-TD-1-C	1	16"W x 4"D x 3"H
B	AAD-TD-2-C	2	16"W x 4"D x 3"H
C	AAD-TD-3-C	3	16"W x 4"D x 3"H
D	AAD-TD-4-C	4	16"W x 4"D x 3"H
E	AAD-TD-5-C	5	16"W x 4"D x 3"H

SLATWALL

	PART #	COMPARTMENTS	DIMENSIONS
A	AAD-TD-1-SL	1	16"W x 4"D x 3"H
B	AAD-TD-2-SL	2	16"W x 4"D x 3"H
C	AAD-TD-3-SL	3	16"W x 4"D x 3"H
D	AAD-TD-4-SL	4	16"W x 4"D x 3"H
E	AAD-TD-5-SL	5	16"W x 4"D x 3"H

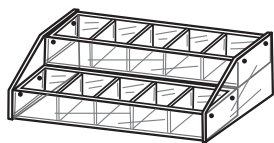

TWO TRAY RACK

Choose any combination of divided trays to make the best display for you.

PART #	DIMENSIONS
AAD-TD-1T	16-1/2"W x 8"D x 6-1/2"H



THREE TRAY RACK

Choose any combination of divided trays to make the best display for you.

PART #	DIMENSIONS
AAD-TD-2D	16-1/2"W x 12"D x 9-1/2"H

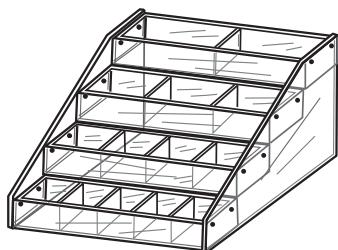

FOUR TRAY RACK

Choose any combination of divided trays to make the best display for you.

PART #	DIMENSIONS
AAD-TD-3D	16-1/2"W x 16"D x 12-1/2"H

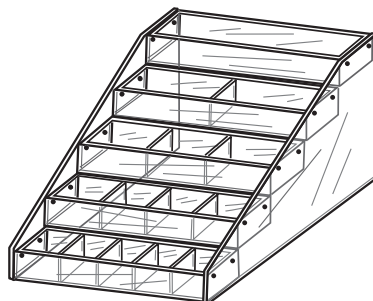

FIVE TRAY RACK

Choose any combination of divided trays to make the best display for you.

PART #	DIMENSIONS
AAD-TD-4T	16-1/2"W x 20"D x 15-1/2"H

DELUXE SLATWALL SHELVES

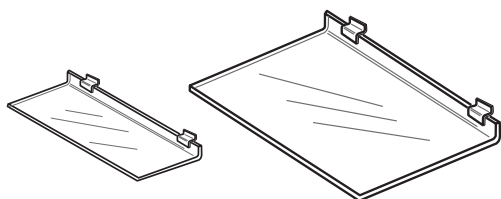

PART #	DIMENSIONS
AAD-SS-1	8"W x 4"D
AAD-SS-2	10"W x 4"D
AAD-SS-3	12"W x 4"D
AAD-SS-4	12"W x 6"D
AAD-SS-5	16"W x 6"D
AAD-SS-6	12"W x 8"D
AAD-SS-7	16"W x 8"D
AAD-SS-8	24"W x 8"D
AAD-SS-9	16"W x 12"D
AAD-SS-10	24"W x 12"D

EXTRA HEAVY DUTY SLATWALL SHELVES

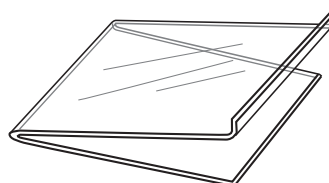

- Design disperses the weight on this shelf over two slatwall grooves making this the strongest and most stable acrylic slatwall shelf available.
- Stable even if bumped and all exposed corners are rounded for safety.

PART #	DIMENSIONS
AAD-SS-1HD	11-3/4" x 9"D

BRACED SLATWALL SHELVES

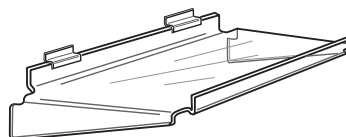

- Braced shelves are perfect for heavy loads.
- 1" high front lip keeps items from falling off shelves.

PART #	DIMENSIONS
AAD-SS-1B	16"W x 10"D
AAD-SS-2B	24"W x 14"D

ACRYLIC SLATWALL TRAYS

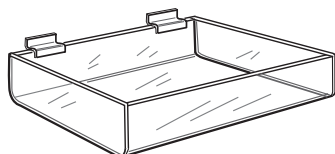

Great for candy, stationery, and other small packaged items.

PART #	DIMENSIONS
AAD-TD-6-SL	8"W x 4"D x 2"H
AAD-TD-7-SL	12"W x 4"D x 2"H
AAD-TD-8-SL	12"W x 8"D x 2"H
AAD-TD-9-SL	16"W x 8"D x 2"H
AAD-TD-10-SL	24"W x 8"D x 2"H
AAD-TD-11-SL	12"W x 6"D x 4"H
AAD-TD-12-SL	16"W x 8"D x 4"H
AAD-TD-13-SL	24"W x 8"D x 4"H

PACKAGED PRODUCT DISPLAYS



A

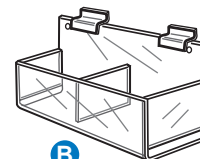

B

PART #	DIMENSIONS
A AAD-TD-19-SL	7-3/4"W x 4-3/4"D
B AAD-TD-20-SL	15-1/2"W x 4-3/4"D

HINGES

CLEAR FLAT HINGES

.086 Thick - PVC
100 Ft. Coils -
Clear with White Web

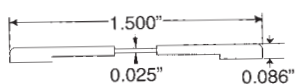

PART #
P4169-CL

CLEAR ACRYLIC/PVC
5 Ft. Lengths

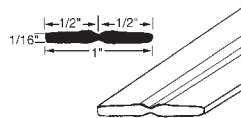

PART #
696H

CLEAR P.E.T.G./PVC
with glue groove
5 Ft. Lengths

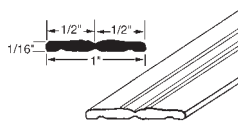

PART #
9888H

CLEAR URETHANE
& ACRYLIC
4 Ft. Lengths
U.V. Stabilized for Outdoor Use!

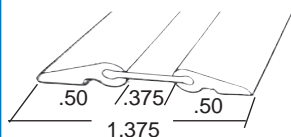

PART #
F2000-CL

CLEAR ECONOMY ACRYLIC HINGE

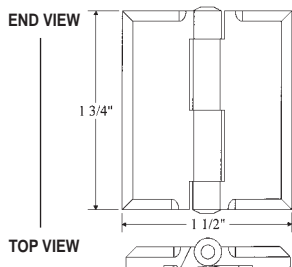

PART #
EC175-150

MONSTER HINGE™

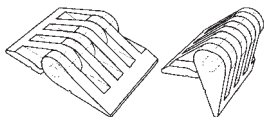

Material: Acrylic DR101 (Clear), ABS (Black)

Indestructible: New "patent pending" design makes this hinge virtually unbreakable!

Ribbed: We have eliminated the barrel section, the weakest part of a hinge, and replaced with large ribbed sections for incredible strength! Larger pin diameter (.190" dia.) too!

PART #	DESCRIPTION
MONSTER-HINGE-CL	Clear Acrylic 1-5/16" L x 2" W x 1/2" Thick Hinge
MONSTER-HINGE-BK	Black ABS 1-5/16" L x 2" W x 1/2" Thick Hinge

PIANO HINGE

Clear or Black
12" Long x 1-3/4" Wide

- Outer bonding surface is wide for added bonding strength.

PART #	MATERIAL
PH-175-12CL	Acrylic
PH-175-12BK	ABS

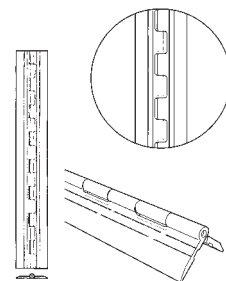

CLEAR ACRYLIC HINGE

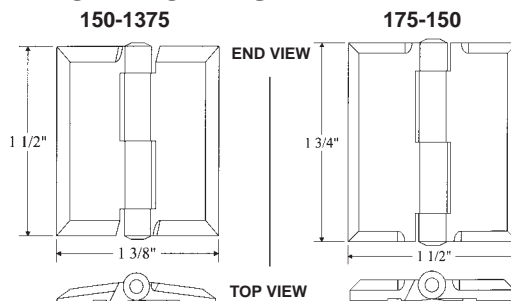

PART #
150-1375
175-150

POLYPROPYLENE HINGE

Black or White
Screw Size Recommended
#10 Countersunk (not included)

PART #	COLOR
200-200-WH	White
200-200-BK	Black

Won't Rust - Quiet - Long Life

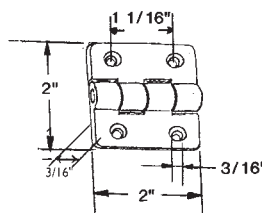

HANGERS

SAWTOOTH HANGER

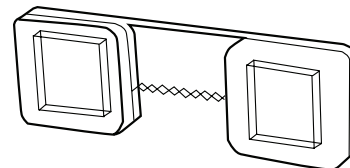

Material: Clear Acrylic

PART #	DESCRIPTION
SAWTOOTH-HANGER	Clear Acrylic 2-1/4" W x 3/4" H x 1/4" D Sawtooth Hanger

KEYHOLE HANGER

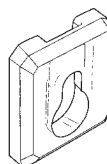

CLEAR
ACRYLIC

1" W x 1-1/8" H
x 1/4" Thick

PART #
KH-100-CL

ACRYLIC FABRICATING PRODUCTS

LOCKS

DECO-HASP

Material: Acrylic DR101 (Clear), ABS (Black)

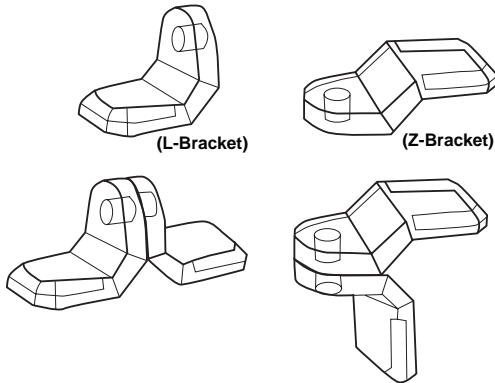

Innovative locking hasp designed for corner or flat applications. No moving parts reduce breakage in the field. Solvent bonds to acrylic, polycarbonate, ABS and styrene.

PART #	DESCRIPTION
DECO-HASP-LCL	Clear Acrylic 7/8" L x 3/4" W x 3/4" H Flat Mount Hasp
DECO-HASP-LBK	Black ABS 7/8" L x 3/4" W x 3/4" H Flat Mount Hasp
DECO-HASP-ZCL	Clear Acrylic 1-3/8" L x 3/4" W x 7/16" H Corner Mount Hasp
DECO-HASP-ZBK	Black ABS 1-3/8" L x 3/4" W x 7/16" H Corner Mount Hasp

ACRYLIC HASP

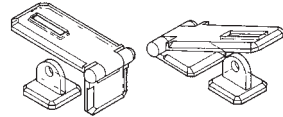

- Color: Clear, Black or White
- 2-3/8" Long x 1-1/16" Wide x 1/8" Thick

Bottom section of hasp is reversible for either corner or flat mounting.
Pre-determine assembly before inserting pin completely!

PART #	COLOR
HSP-110-CL	Clear
HSP-110-BK	Black
HSP-110-WH	White

SLIDING GLASS SHOWCASE DRAWER LOCK

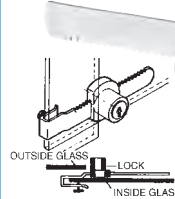

- Material: Metal construction
- Chrome plated finish
- Size: 5-1/2" Ratchet bar
- Drawer Thickness: From 3/16" to 1/4" glass panel
- Keyed alike only

PART #
RA710-CHR-KA

Spare Keys for RA710-CHR-KA
#KY-035...set of two

CAM LOCK



- Material: Metal construction
- Chrome plated finish
- Size: 7/8"
- Drawer Thickness: Up to 5/8" panel
- Keyed alike only

PART #
RA709-CHR-KA

Spare Keys for RA709-CHR-KA
#KY-135...set of two

CATCHES MAG-CATCH™ with Strike Plate

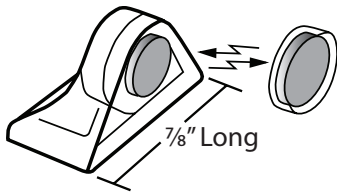

- Material: Acrylic DR101 (Clear), ABS (Black)
- Pull Force: 1 lb.
- Size: 7/8" L x 1/2" H x 3/8" W
- Adhesive mount

Adhesive mount solvent bonds to acrylic, polycarbonate, ABS and styrene. Eliminates unsightly screws or hardware.

PART #	DESCRIPTION
MC-SM-CL	Acrylic Magnetic Door Catch
MC-SM-BK	Black ABS Magnetic Door Catch

SHELF PILASTERS SHELF TRACKER™

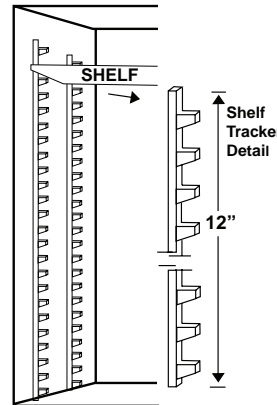

- Material: Clear Acrylic
- Length: 12" long
- For up to 1/4" thick shelves with 1/2" adjustment
- Easily mates for longer applications
- Solvent bonds to Acrylic, ABS, Polycarbonate and Styrene
- Size: 12" L x 5/16" W x 3/8" T (305mm x 87mm x 9.5mm)

PART #	DESCRIPTION
ST-CL	Clear Acrylic Shelf Tracker

DOOR CATCH with Strike Plate



- Material: Clear Acrylic
- Size: 5/8" L x 1-5/16" W
- Adhesive mount

PART #
DC-100-CL

BUSINESS CARD HOLDER

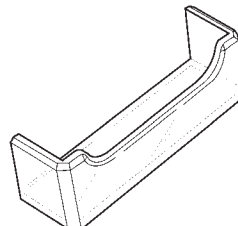

- Material: Clear Acrylic
- Size: 3-5/8" W x 3/4" D x 7/8" H

PART #
BC-200-CL

ACRYLIC FABRICATING PRODUCTS

"Z" & "W" BAR

632Z, 9881Z
4 FT. Lengths

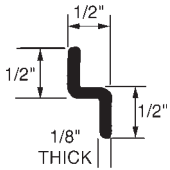

635Z, 9882Z
4 FT. Lengths

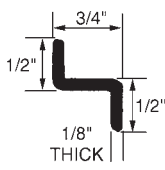

634W, 9885W
4 FT. Lengths

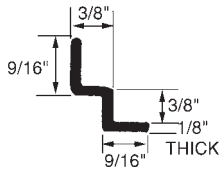

633W, 9884W
4 FT. Lengths

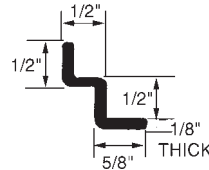

ALUZ5-M, ALUZ75-M
8 FT. Lengths

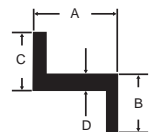

PART#	A	B	C	D
ALUZ5-M	1/2"	1/2"	1/2"	3/32"
ALUZ75-M	3/4"	3/4"	3/4"	1/8"

Material: Clear Acrylic- 25% DR

- PART #**
632Z-4
635Z-4
633W-4
634W-4

Material: Clear Acrylic- 100% DR

- PART #**
632Z-100-4
635Z-100-4
633W-100-4
634W-100-4

Material: Clear P.E.T.G.

- PART #**
9881Z-4
9882Z-4
9884W-4
9885W-4

Material: Aluminum With Mill Finish (M)

- PART#**
ALUZ5-M
ALUZ75-M

CLEAR POLYESTER HOOKS

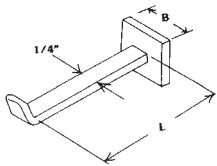

Perfect For Jewelry Displays -
Just Glue Them On!
1/4" Flat

PART #	L	B
QFH-48	1-1/2"	5/8" SQ.

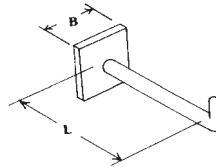

1/8" ROUND

PART #	L	B
RH-32	1"	1/2" sq.
RH-48	1-1/2"	5/8" sq.
RH-64	2"	5/8" sq.

CLEAR ACRYLIC "J" BAR FOR GRIDWALL

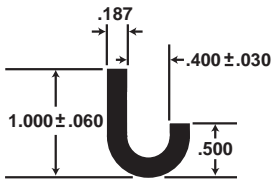

1" Leg and .400" Gap
4 FT. Lengths

- PART #**
636J

ACRYLIC SIGN CHANNEL

Make Your Own Sign!

Now you can easily design and manufacture multi-track changeable signs in any width you desire with our Acrylic Sign Channel. The acrylic sign channels have 1/4" wide adhesion surfaces. Adhesive sold separately.

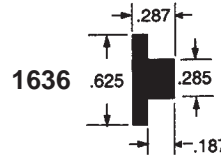
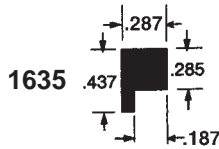

CLEAR • 6 FOOT LENGTHS

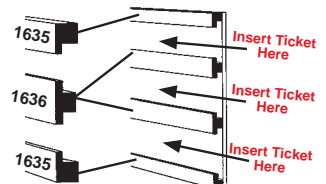

- PART#**
1635
1636

VISION WARE RESTS



CLEAR ACRYLIC
Glue Onto 5/8" Rod

- PART #**
R21-1



CLEAR ACRYLIC
Glue Onto Flat Surface

- PART #**
R21-2



CLEAR POLYCARBONATE
For Slatwall

- PART #**
R21-3



CLEAR ACRYLIC
For 1/4" Pegboard

- PART #**
R21-4

1/2" ADJUSTABLE MERCHANDISING HOOK SYSTEM

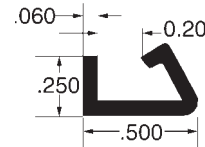

CLEAR ACRYLIC
6 FT. LENGTHS

- PART #**
EA-20CL

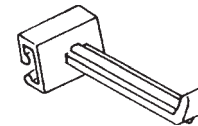

(1-1/2" ribbed clip hook)

- PART #**
RCH-48

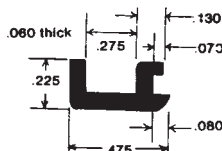

6 FT. LENGTHS

- PART #**
EA-30CL

BINNING STRIPS

OUR BINNING STRIP MAKES IT EASY TO ADJUST SPACING & ACCOMMODATE YOUR NEEDS

Material: Ivory, White, Black & Clear Styrene

Versatile plastic band strip can be installed on counters, tables, cabinets, in drawers - anywhere. Accepts various types of dividers. Economical yet easily installed.

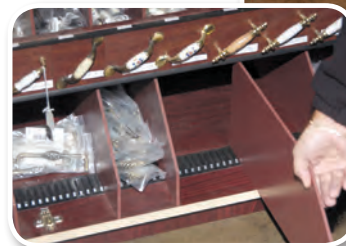

STANDARD BABY BINNING STRIP

FOR 1/4" DIVIDER

Works independently of standard binning strip

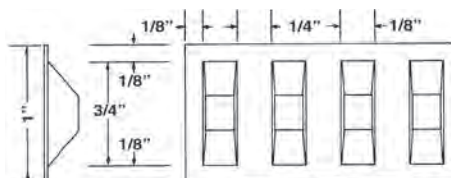

PART #	DESCRIPTION
292-BK-60	60"-Black-No adhesive
292-CL-60	60"-Clear-No adhesive
292-IV-60	60"-Ivory-No adhesive
292-WH-60	60"-White-No adhesive
292A-BK-60	60"-Black-w/adhesive
292A-CL-60	60"-Clear-w/adhesive
292A-IV-60	60"-Ivory-w/adhesive
292A-WH-60	60"-White-w/adhesive

STANDARD BINNING STRIP

FOR 1/4" DIVIDER

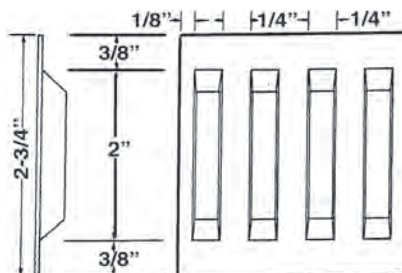
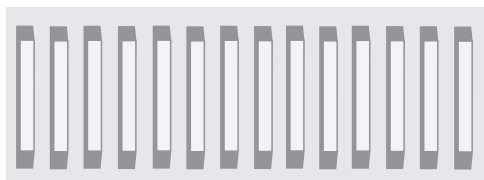

PART #	DESCRIPTION
282-CL-48	48"-Clear-No adhesive
282-CL-60	60"-Clear-No adhesive
282-IV-48	48"-Ivory-No adhesive
282-IV-60	60"-Ivory-No adhesive
282-WH-48	48"-White-No adhesive
282-WH-60	60"-White-No adhesive
282-BK-60	60"-Black-No adhesive
282A-CL-48	48"-Clear-w/adhesive
282A-CL-60	60"-Clear-w/adhesive
282A-IV-48	48"-Ivory-w/adhesive
282A-IV-60	60"-Ivory-w/adhesive
282A-WH-48	48"-White-w/adhesive
282A-BK-48	48"-Black-w/adhesive
282A-WH-60	60"-White-w/adhesive
282A-BK-60	60"-Black-w/adhesive

STANDARD BINNING STRIP

FOR 1/8" DIVIDER

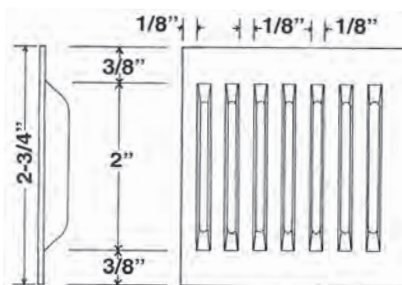
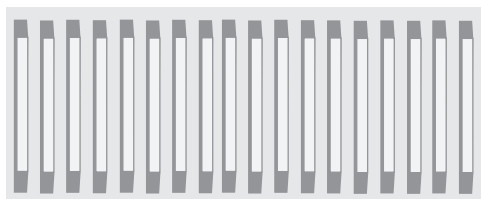

PART #	DESCRIPTION
182-CL-60	60"-Clear-No adhesive
182-IV-60	60"-Ivory-No adhesive
182-WH-60	60"-White-No adhesive
182-BK-60	60"-Black-No adhesive
182A-CL-60	60"-Clear-w/adhesive
182A-IV-60	60"-Ivory-w/adhesive
182A-WH-60	60"-White-w/adhesive
182A-BK-60	60"-Black-w/adhesive

SLATWALL

E-Z SLATWALL

World's Best Looking Slatwall

Material: HIGH DENSITY POLYSTYRENE
Length: 8' x 3"
3" on center

Interlocking Slatwall can be mixed/matched with any color combination

AVAILABLE IN 8 FINISHES



- The 1st 100% Recycled Slatwall
- Super Lightweight but **STRONG!**
- Panel 13/16" thick
- Holds 20 lbs. per sq. ft.
- 8 ft. Lengths; runs horizontal
- Can be screwed, nailed or glued into place
- Installed with standard tools
- Furniture grade quality
- Grooves are pre-finished
- Color through material
- Free samples available - please inquire

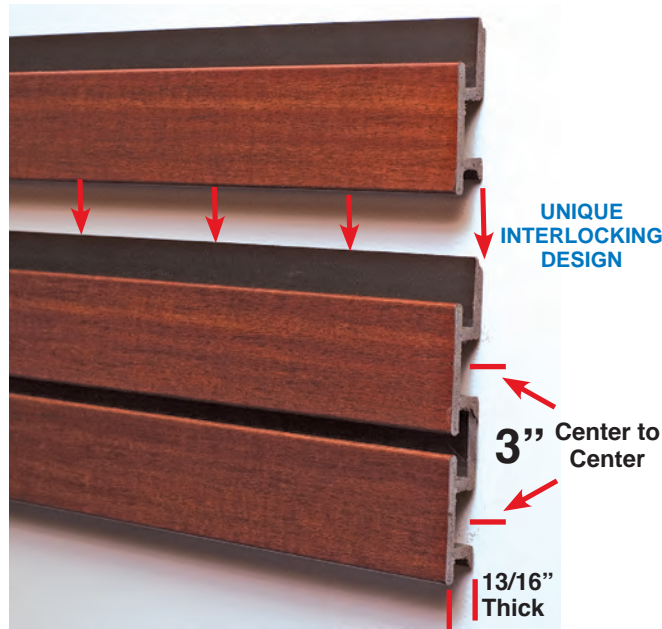

See pages 383-387 for Garage Accessories



FITS ALL STANDARD HOOKS, BASKETS & BRACKETS

PART#	FINISH
EZ-SLAT3-01	Stainless Steel
EZ-SLAT3-02	Ebony/Black
EZ-SLAT3-03	Cherry/Mahogany
EZ-SLAT3-04	Oil Rubbed Bronze
EZ-SLAT3-05	Walnut/Chestnut
EZ-SLAT3-06	Burnished Copper
EZ-SLAT3-07	Eggshell White
EZ-SLAT3-08	Silver

E-Z SLATWALL



**ANYONE
CAN DO!**

Material: HIGH DENSITY POLYSTYRENE

Length: 8' x 3"

3" on center

- Turn barren walls into money making opportunities
- World Best Looking Slatwall
- Available In 8 Finishes
- Create More Selling Opportunities
- Quickly Remodel
- Cut With Hand Saw & Screw



**Window
Display**



Mill Finish
Slatwall Insert
8' Long



**PART #
ALU710-M**

*For more Slatwall Inserts,
see page 112*



MP-25-ADH
The "Original" Hybrid Formula

MP-25-ADH is a high performance, one component, permanently flexible, easy to use, multi-purpose fast cure modified polyurethane sealant. MP-25-ADH cures rapidly when exposed to atmospheric moisture to form a durable bond.

- Use as adhesive or filler
- Eco-friendly, low VOC's
- Fast cure
- Paintable
- Non-yellowing

**PART #
MP-25-ADH**



- 16 sq. ft. per box
- 8 pieces per box
- 17 lbs. per box
- Ships UPS - No crating fee

LIGHT DUTY PVC SLATWALL PANELS

Material: RIGID PVC
Length: 6" x 48"
1" on Center

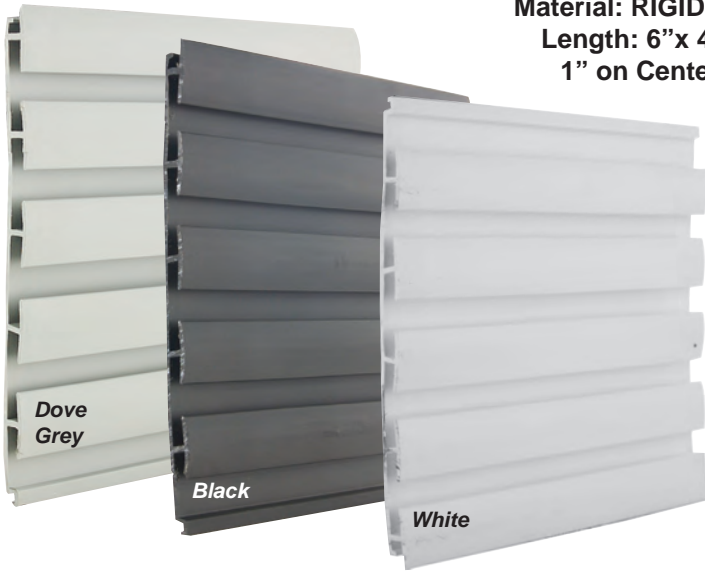

- Panel 5/16" Thick
- 4-5 lbs per square ft load capacity
- Easy To Install
- Light Weight Yet Strong
- Acid & Alkali Resistant

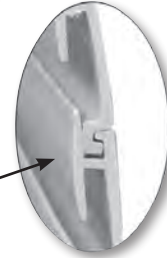
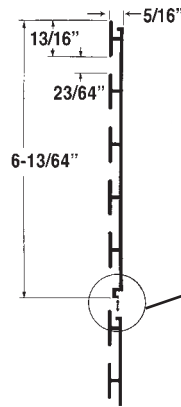

Unique Interlocking Design

PART #	COLOR
SLAT648	White
SLAT648BK	Black
SLAT648DG	Dove Grey

DOUBLE SIDED ALUMINUM SLATWALL PANELS

Material: Aluminum
Length: 5" x 12'
1-1/2" on center

- Panel 1/2" Thick
- 100 Lbs per Square Foot Load Capacity

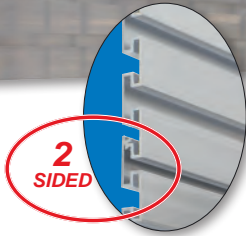
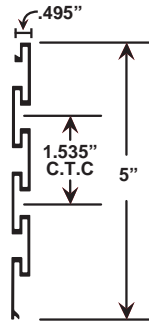

Innovative design: Allows for use of both sides of the panel.

END CHANNEL FOR EDGES

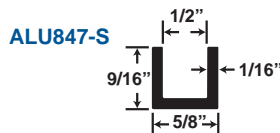

PART #	FINISH	DESCRIPTION
ALU847-M	Mill	12' Long
ALU847-S	Clear Anodized	12' Long

Other colors available. Minimums apply. Please inquire.

For use with all accessories in the Slatwall Hardware section except the following
 SWB/1266*, SWB/12124* & SWB/12244*

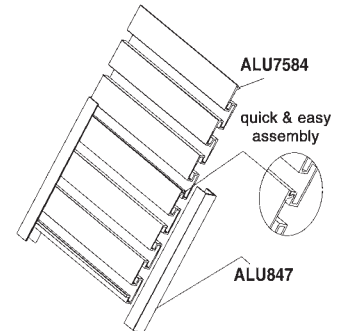

Finishes available: CLEAR ANODIZED & MILL

PART #	FINISH	DESCRIPTION	PER CTN.
ALU7584-M	Mill	5" x 12' Long Slatwall	16 pcs.
ALU7584-S	Clear Anodized	5" x 12' Long Slatwall	6 pcs.

STANDARD DUTY PANELS

Material: PVC

Lengths: 1' x 4' and 1' x 8'
3" on center

- Panel 11/16" Thick
- 25 Lbs. per Sq. Ft. Load Capacity

PART #	DESCRIPTION
GRW-1X4-WH	1' x 4' White Great Wall Panel
GRW-1X4-BK	1' x 4' Black Great Wall Panel
GRW-1X4-AL	1' x 4' Almond Great Wall Panel
GRW-1X4-MP	1' x 4' Maple Great Wall Panel
GRW-1X8-WH	1' x 8' White Great Wall Panel
GRW-1X8-BK	1' x 8' Black Great Wall Panel
GRW-1X8-AL	1' x 8' Almond Great Wall Panel
GRW-1X8-MP	1' x 8' Maple Great Wall Panel

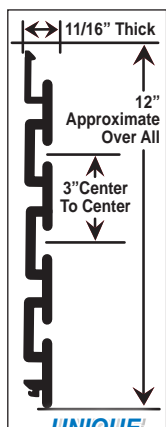

UNIQUE INTERLOCKING DESIGN SECURELY FITS TOGETHER

** Must be ordered in full boxes of 8 pcs. x 4 ft. or 4 pcs. x 8 ft.*



MIX & MATCH

HERCULES HEAVY DUTY

New

Material: Aluminum

Length: 6" x 8"
3" on center

- Panel 11/32" Thick
- 300 Lbs. per Sq. Ft. Load Capacity
- Aluminum Slatwall designed to interlock with Standard Duty PVC Slatwall when extra strength is needed.

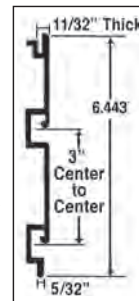

PART #	FINISH
ALU6969-S	Satin
ALU6969-M	Mill

FOR USE WITH ALL ACCESSORIES IN THE SLATWALL HARDWARE SECTION

HIGH DENSITY HEAVY DUTY PANELS

Material: PVC

Lengths: 1' x 4' and 1' x 8'
3" on center

- Panel 11/16" Thick
- 100 Lbs. per Sq. Ft. Load Capacity

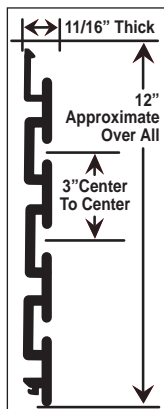

PART #	DESCRIPTION
GRW-HD1X4-WH	1' x 4' White Great Wall Panel
GRW-HD1X4-BK	1' x 4' Black Great Wall Panel
GRW-HD1X4-AL	1' x 4' Almond Great Wall Panel
GRW-HD1X4-MP	1' x 4' Maple Great Wall Panel
GRW-HD1X8-WH	1' x 8' White Great Wall Panel
GRW-HD1X8-BK	1' x 8' Black Great Wall Panel
GRW-HD1X8-AL	1' x 8' Almond Great Wall Panel
GRW-HD1X8-MP	1' x 8' Maple Great Wall Panel

** Must be ordered in full boxes of 8 pcs. x 4 ft. or 4 pcs. x 8 ft.*

COLOR MATCH MOULDINGS

Material: PVC

See Pgs. 383-387 For Garage Hardware

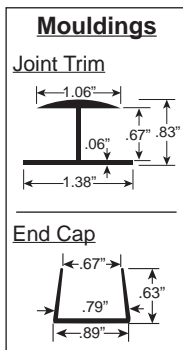

PART #	DESCRIPTION
GRW-JNR8-WH	8' White Joint Trim For Great Wall
GRW-JNR8-BK	8' Black Joint Trim For Great Wall
GRW-JNR8-AL	8' Almond Joint Trim For Great Wall
GRW-JNR8-MP	8' Maple Joint Trim For Great Wall
GRW-END8-WH	8' White End Cap For Great Wall
GRW-END8-BK	8' Black End Cap For Great Wall
GRW-END8-AL	8' Almond End Cap For Great Wall
GRW-END8-MP	8' Maple End Cap For Great Wall

COLOR MATCH SCREWS

Material: Steel

PART #	DESCRIPTION
GRW-2500SCR-WH	2-1/2"-L White Screw For Great Wall
GRW-2500SCR-BK	2-1/2"-L Black Screw For Great Wall
GRW-2500SCR-AL	2-1/2"-L Almond Screw For Great Wall
GRW-2500SCR-MP	2-1/2"-L Maple Screw For Great Wall

** Screws packed 100 pcs. per box*

SLATWALL & SLATWALL SYSTEMS

WOOD SLATWALL PANELS

WITH AND WITHOUT INSTALLED ALUMINUM INSERTS

Length: 4' x 8'
3" on center

- Low Pressure Laminate
- With Unfinished Grooves
- Grooves Run in 8 Ft. Direction

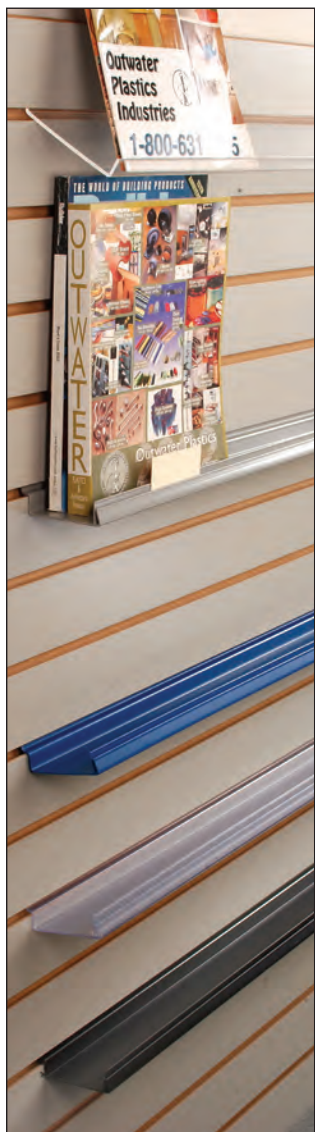

WOOD SLATWALL PANELS ONLY

PART #	DESCRIPTION
SW48-WH	White LPM
SW48-FG	Fog Gray LPM
SW48-AL	Almond LPM
SW48-OAK	Oak Woodgrain LPM
SW48-MP	Maple Woodgrain LPM
SW48-PT	Paint Grade MDF
SW48-ALU	Brushed Aluminum LPL
SW48-MAH	Mahogany Woodgrain LPL
SW48-PE	Pearwood Woodgrain LPL
SW48-MIR	Clear Mirror Acrylic

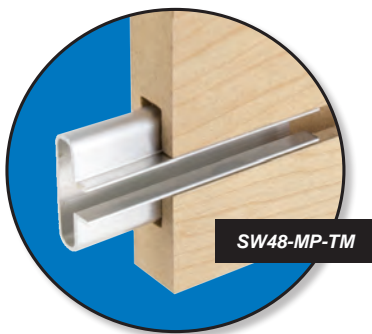

WOOD SLATWALL PANELS w/ALUMINUM INSERTS INSTALLED

Mill Finish • 8 Ft. Lengths

For Added Strength & Durability and Superior Appearance

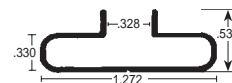

PART #	DESCRIPTION
SW48-WH-TM	White LPM
SW48-FG-TM	Fog Gray LPM
SW48-AL-TM	Almond LPM
SW48-OAK-TM	Oak Woodgrain LPM
SW48-MP-TM	Maple Woodgrain LPM
SW48-PT-TM	Paint Grade MDF
SW48-ALU-TM	Brushed Aluminum LPL
SW48-MAH-TM	Mahogany Woodgrain LPL
SW48-PE-TM	Pearwood Woodgrain LPL
SW48-MIR-TM	Clear Mirror Acrylic

ALL ORDERS MUST SHIP VIA FREIGHT

SLATWALL INSERTS

ALUMINUM INSERT FOR SLATWALL

Fits Marlite Brand Slatwall
Mill Finish • 8 Ft. Lengths

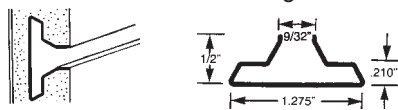

PART #
ALU710-M

VINYL INSERT FOR WOOD SLATWALL

Fits the SW48 Wood and Marlite Brand Slatwall
8 Ft. Lengths

PART#	COLOR
SLAT-J-BK	Black
SLAT-J-WH	White
SLAT-J-LG	Light Gray
SLAT-J-IV	Ivory

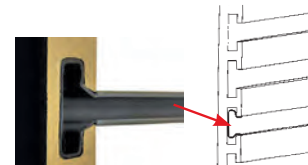

SLATWALL TEXT PANELS

Material: A polymer plastic surface with an MDF back

Length: 2' x 8' Sheets

6" on center

Our Slat Text Panels are a one of a kind innovation for the display market, allowing stores to transform ordinary merchandise setups into a themed decor. They are made from a solid MDF board that is designed to accept slate wall shelving and fixtures.

FEATURES

- Custom colors are available upon request.
- All panels are reinforced with inserts.
- Horizontal configuration only.

Our 3 DIMENSIONAL SLATTEX Panels are unrivaled in realism.

If you're looking to break from the traditional laminate slatwall, this is for you.

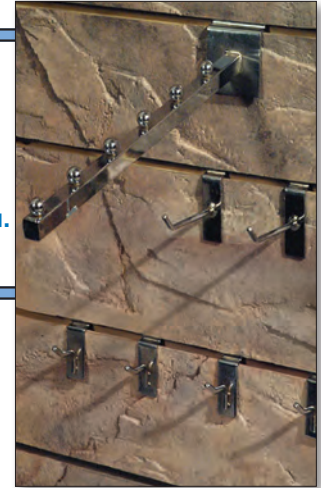

Slatwall accessories available, See pgs. 114-117

BRICK



SWP-10 Sandstone



SWP-15 Red Brick

BARNWOOD



SWP-20 Natural

SLATE



SWP-30 Natural

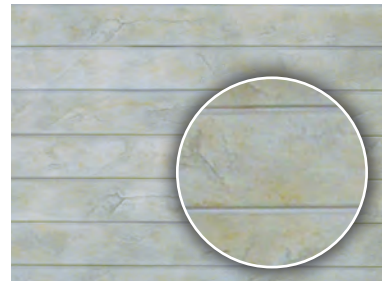

SWP-35 White

METAL



SWP-40 Rust



SWP-45 Gray

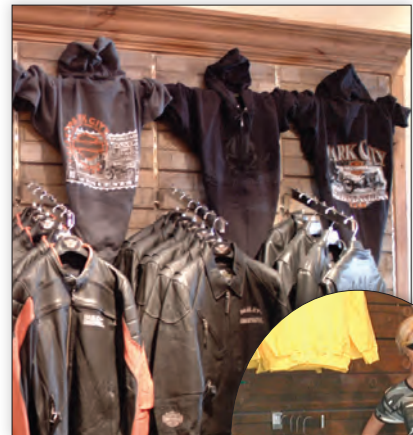

Additional panels available

- High profile dimensional surface
- Tough, impact resistant surface
- Multiple "Themed" textures
- Fade resistant colored surface
- Easy to install and expand

SLATWALL HARDWARE

METAL DISPLAY ARMS

HANGRAIL BRACKET WITH RETURN TO FIT 3" O.C. SLATWALL

BRIGHT CHROME STEEL

10" Long, with "O" cup for 1-1/4" diameter tubing



PART #
SW/RHR12-BC

KNIFE BRACKET

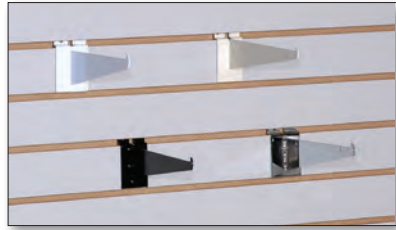

BLACK (BK), ALMOND*(AL), WHITE (WH) or BRIGHT CHROME (BC)

** Almond not available in SW10KB, SW12KB & SW16KB*

PART #

- SW8KB-BC
- SW8KB-AL
- SW8KB-BK
- SW8KB-WH
- SW10KB-BC
- SW10KB-BK
- SW10KB-WH
- SW12KB-BC
- SW12KB-WH
- SW12KB-BK
- SW14KB-BC
- SW14KB-AL
- SW14KB-BK
- SW14KB-WH
- SW16KB-BC
- SW16KB-BK
- SW16KB-WH

HEAVY DUTY SUPPORT ARM FOR SLATWALL

Heavy Duty Steel Support Arms are for use with both knife & hangrail brackets on slatwall. 3/8" dia. arm with "U" shaped cup & screws to secure cup to bracket.

BRIGHT CHROME ONLY STEEL

HD/SW-S is recommended for brackets 8"-12" long.

HD/SW-L is recommended for brackets 12" or longer.

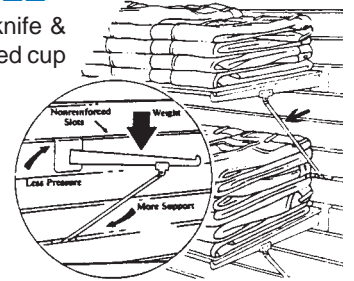
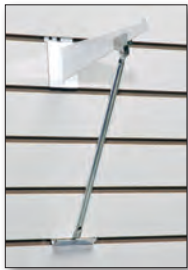

CLEAR ROUND SHELF BUMPERS



Works with the wood shelf brackets and clear polycarbonate

PART #
BH100CL

VISION WARE REST

Polycarbonate



PART #
R21-3

SLATWALL SHELF BRACKET

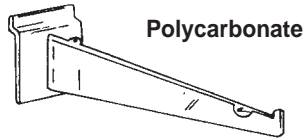
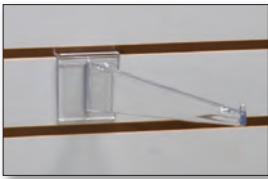

PART #	SIZE
4PKB/SW-CL	4"
6PKB/SW-CL	6"
8PKB/SW-CL	8"
10PKB/SW-CL	10"
12PKB/SW-CL	12"
14PKB/SW-CL	14"

SLATWALL ADAPTER CLIP

Styrene Material

- Attaches signs, literature holders & lightweight displays flush up against slatwall.
- 1" clip fits most standard slatwall.

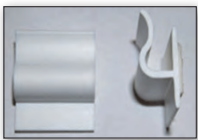

Adhesive holds sign or display

PART # COLOR
SWA-10 White

"Z" BAR SLATWALL ADAPTER

Crystal Clear PVC

- Holds signs and lightweight literature holders to slatwall.
- 1-1/2" wide adapter.
- Permanent foam tape self adhesive included.

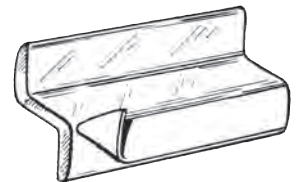

PART #
ZB-20

Other sizes available, please go to page 106 for more details.

SLATWALL HARDWARE

HOOKS

*WHITE (WH), *BLACK (BK) or
*FASHION GRAY (FG) GLASS FILLED NYLON



PART #	SIZE
SW/H2*	2"
SW/H4*	4"
SW/H6*	6"
SW/H8*	8"
SW/H10*	10"

BRIGHT CHROME METAL

1/4" DIA. HOOK
WITH 30° UPTURN



PART #	SIZE
SW/H1-BC	1"
SW/H4-BC	4"
SW/H6-BC	6"
SW/H8-BC	8"
SW/H10-BC	10"
SW/H12-BC	12"

CLEAR POLYCARBONATE HANGER



PSW/HF
3/8"L

PART #
PSW/HF
PSW/H1

PSW/H1
5/8"L
w/90°upturn



BRIGHT CHROME
METAL HANGER

PART #
SW/HF



METAL DISPLAY ARMS - Black (BK), White (WH) or Bright Chrome Steel (BC)

SQUARE DOWN SLANT WITH BALLS



16" Long,
3/4" square
tubular arm
with six balls

PART #
SW/6B-

RECTANGULAR DOWN SLANT
WITH CUBES



16" Long,
1/2" x 1-1/2"
tubular arm
with seven
cubes

*Not available
in White*

PART #
SW/R7B-BC
SW/R7B-BK

SQUARE DOWN SLANT
WITH HOOKS

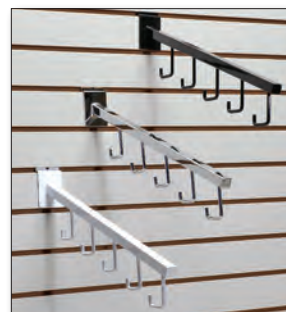

16" Long,
3/4" square
tubular arm
with five
hooks

*Not available
in White*

PART #
SW/5H-

RECTANGULAR DOWN SLANT
WITH HOOKS



16" Long,
1/2" x 1-1/2"
tubular arm
with five
hooks

*Not available
in White*

PART #
SW/R5H-

SQUARE STRAIGHT OUT



12" Long,
3/4" square
tubular arm
with ball end
stop

PART #
SW/12-

RECTANGULAR STRAIGHT OUT



12" Long,
1/2" x 1-1/2"
tubular arm
with flat end
stop

PART #
SW/R12-BC
SW/R12-BK
SW/R12-WH

SLATWALL HARDWARE

HANGBAR ACCESSORIES

BRIGHT CHROME SLATWALL HANGBAR

24" long x 12" depth
Made with 1-1/4" round tube



PART #
SW/HB-BC

SLATWALL SCARECROW

BLACK, CHROME, WHITE

Adjustable from 26-3/4" to 34-3/4"



PART #	COLOR
SW/SCW-BC	Bright Chrome
SW/SCW-BK	Black
SW/SCW-WH	White

WIRE BASKET ACCESSORIES - Black or White

NARROW BASKET

12"W x 6"D x 6"H



PART #	COLOR
SWB/1266-BK	Black
SWB/1266-WH	White

SMALL BASKET

12"W x 12"D x 4"H



PART #	COLOR
SWB/12124-BK	Black
SWB/12124-WH	White

DEEP BASKET

12"W x 12"D x 8"H



PART #	COLOR
SWB/12128-BK	Black
SWB/12128-WH	White
SWB/12128-CH	Chrome

SHALLOW BASKET

24"W x 12"D x 4"H

PART #	COLOR
SWB/12244-BK	Black
SWB/12244-WH	White



HEAVY DUTY BASKET

CHARCOAL



PART #	SIZE	CTN. QTY.
SWB-BSKT-312	3"D x 12"W	6 Pcs.
SWB-BSKT-812	8"D x 12"W	4 Pcs.
SWB-BSKT-1218	12"D x 18"W	4 Pcs.
SWB-BSKT-1224	12"D x 24"W	4 Pcs.

SLATWALL ACCESSORIES

TICKET HOLDER

CLEAR BUTYRATE -
12 FT. LENGTHS
Fits 1-1/4" Ticket

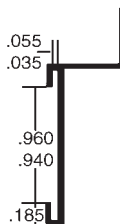

PART #
62-CL

ALUMINUM SLATWALL SHELF SUPPORT BRACKET

AVAILABLE IN 1', 2', 4' OR 8' LENGTHS*
Made of Clear Anodized Aluminum
HOLDS UP TO 12" D SHELF x 1/4" OR 3/4" THICK
(SCREWS INCLUDED FOR 3/4" THICK ONLY)

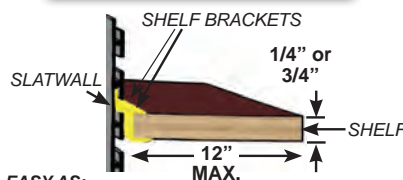

EASY AS:
1 - PICK SHELF LENGTH
2 - INSERT SHELF INTO EXTRUSION
3 - HANG ON SLATWALL

	PART #	LENGTH
1/4" THICK SHELF	51790-1	1'
	51790-2	2'
	51790-4	4'

	PART #	LENGTH
3/4" THICK SHELF	41790-1	1'
	41790-2	2'
	41790-4	4'
	41790-8	8'

* THE LENGTH OF THE BRACKET IS 1/4" LESS THAN THE SUGGESTED SHELF LENGTH

SLATWALL HARDWARE

"Z" & "W" BAR

632Z, 9881Z

4 FT. Lengths

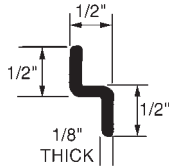

635Z, 9882Z

4 FT. Lengths

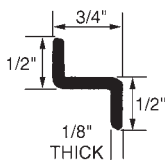

634W, 9885W

4 FT. Lengths

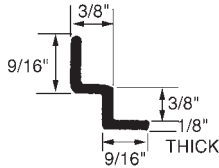

633W, 9884W

4 FT. Lengths

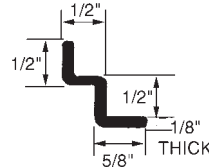

ALUZ5-M, ALUZ75-M

8 FT. Lengths

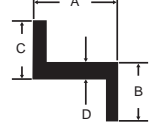

PART#	A	B	C	D
ALUZ5-M	1/2"	1/2"	1/2"	3/32"
ALUZ75-M	3/4"	3/4"	3/4"	1/8"

Material: Clear Acrylic- 25% DR

Material: Clear Acrylic- 100% DR

Material: Clear P.E.T.G.

Material: Aluminum With Mill Finish (M)

PART #

632Z-4

635Z-4

633W-4

634W-4

PART #

632Z-100-4

635Z-100-4

633W-100-4

634W-100-4

PART #

9881Z-4

9882Z-4

9884W-4

9885W-4

PART#

ALUZ5-M

ALUZ75-M

• MADE IN U.S.A • FLAME POLISHED EDGES • .100 THICK ACRYLIC SHELVES

CLEAR ACRYLIC - 3/16" THICK WITH HEAT BENT GUSSETS FOR EXTRA SUPPORT

PART # WIDTH LENGTH

873-SL	8"	24"
874-SL	8"	36"
878-SL	10"	24"
879-SL	10"	36"

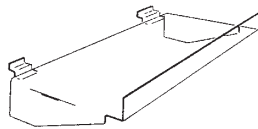

PACKED 6 PER CARTON *

CLEAR ACRYLIC - nominal 1/8" material

PART # WIDTH HEIGHT

662-SL	4"	16"
663-SL	4"	20"
664-SL	4"	24"
665-SL	6"	16"

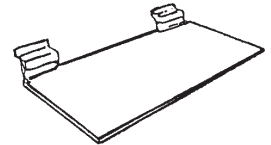

PACKED 12 PER CARTON *

LITERATURE HOLDERS

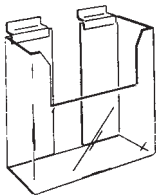

CLEAR ACRYLIC - nominal 1/8" material
**WIDTH ALLOWS CLEARANCE FOR SIZES SHOWN

PART # **W x H

47SL-1	3-1/2" x 7"
47SL-2	4" x 7"
47SL-3	4-7/8" x 7"
47SL-5	8-1/2" x 9"

PACKED 12 PCS. PER CARTON *

SIGN HOLDERS

CLEAR ACRYLIC - nominal 1/8" material

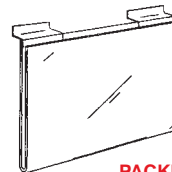

PACKED 6 PCS. PER CARTON *

PART # W x H

516-SL	5-1/2" x 7"
517-SL	7" x 5-1/2"
518-SL	7" x 11"
519-SL	11" x 7"
520-SL	8-1/2" x 11"
521-SL	11" x 8-1/2"
522-SL	11" x 14"
523-SL	14" x 11"

ACRYLIC SLATWALL TRAYS

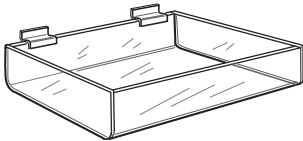

Great for candy, stationery, and other small packaged items.

PART # DIMENSIONS

AAAD-TD-6-SL	8"W x 4"D x 2"H
AAAD-TD-7-SL	12"W x 4"D x 2"H
AAAD-TD-8-SL	12"W x 8"D x 2"H
AAAD-TD-9-SL	16"W x 8"D x 2"H
AAAD-TD-10-SL	24"W x 8"D x 2"H
AAAD-TD-11-SL	12"W x 6"D x 4"H
AAAD-TD-12-SL	16"W x 8"D x 4"H
AAAD-TD-13-SL	24"W x 8"D x 4"H

SLATWALL BINS

Perfect for holding merchandise of various sizes on slatwall, made from heavy 3/16" acrylic.

PART # DIMENSIONS

AAAD-TD-14-SL	4" Square
AAAD-TD-15-SL	6" Square
AAAD-TD-16-SL	8" Square
AAAD-TD-17-SL	10" Square
AAAD-TD-18-SL	12" Square

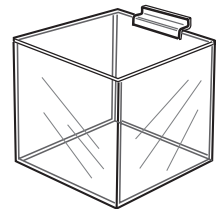

SLATWALL CARD RACKS

PART # DIMENSIONS

AAAD-CD-1-SL	11-3/4"W- Open End
AAAD-CD-2-SL	23-3/4"W- Open End
AAAD-CD-3-SL	35-3/4"W- Open End
AAAD-CD-4-SL	47-3/4"W- Open End

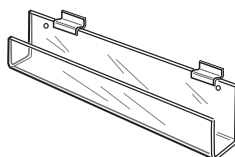

PACKAGED PRODUCT DISPLAYS

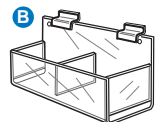

PART # DIMENSIONS

A	AAAD-TD-19-SL	7-3/4"W x 4-3/4"D
B	AAAD-TD-20-SL	15-1/2"W x 4-3/4"D

For our complete line of acrylic products, See pages 94-106

GRIDWALL PANELS

1/4" Steel Wire - 3" O.C. Grid.
Vertical sides have double wire.

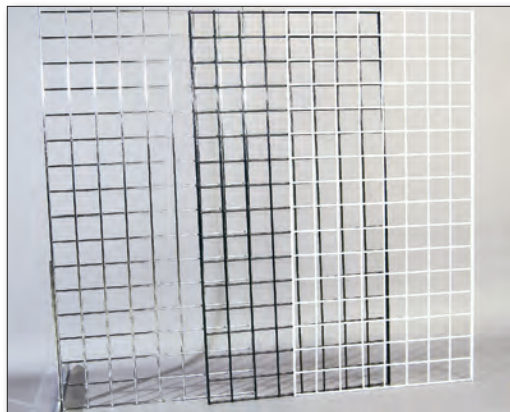

PART #	FINISH/COLOR	SIZE
GW24-BC	Bright Chrome	2' W x 4' H
GW24-BK	Black	2' W x 4' H
GW24-WH	White	2' W x 4' H
GW25-BC	Bright Chrome	2' W x 5' H
GW25-BK	Black	2' W x 5' H
GW25-WH	White	2' W x 5' H
GW26-BC	Bright Chrome	2' W x 6' H
GW26-BK	Black	2' W x 6' H
GW26-WH	White	2' W x 6' H
GW27-BC	Bright Chrome	2' W x 7' H
GW27-BK	Black	2' W x 7' H
GW27-WH	White	2' W x 7' H
GW28-BC	Bright Chrome	2' W x 8' H
GW28-BK	Black	2' W x 8' H
GW28-WH	White	2' W x 8' H

• NOTE: SHEETS ARE PACKED 2 PER CARTON

BASES FOR GRIDWALL



DELUXE "T" LEGS
PART # FINISH

GW/TLEG Bright Chrome

GW/TLEG-BK Black

3/16" x 1" vertical bar.

1/2" x 1-1/2" horizontal tube with 2 adjustable levelers to prevent rocking and 3 nuts & bolts to assure stability.



4 Way Base For Grid Panels Includes Casters

DELUXE "T" LEGS
PART # FINISH

GW4BA-BC Bright Chrome

GW4BA-BK Black

24"W x 18-1/2"H.

Levelers Included: 3/8" x 1" Long.

Note: Casters with same stem will fit into legs.

GRIDWALL HOOKS



Steel - 1/4" Dia. Gridwall Hook

PART # SIZE FINISH

GW/H4-BC 4" Bright Chrome

GW/H4-BK 4" Black

GW/H6-BC 6" Bright Chrome

GW/H6-BK 6" Black

GW/H6-WH 6" White

GW/H8-BC 8" Bright Chrome

GW/H8-BK 8" Black

GW/H8-WH 8" White

GW/H10-BC 10" Bright Chrome

GW/H10-BK 10" Black

GW/H10-WH 10" White

GW/H12-BC 12" Bright Chrome

GW/H12-BK 12" Black

GW/H12-WH 12" White

METAL DISPLAY ARMS FOR GRIDWALL



7 BALL SQUARE WATERFALL

STEEL - 16" LONG

PART # FINISH
GW/S7C-BC Bright Chrome

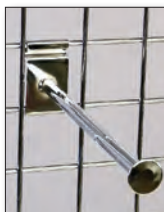

ROUND FACE OUT

STEEL

12" ROUND TUBING FACE OUT WITH DISK AT END

PART # FINISH
GW11-BC Bright Chrome



RECTANGULAR STRAIGHT OUT

STEEL - 12" LONG

PART # FINISH
GWR12-BC Bright Chrome



5 HOOK SQUARE WATERFALL

STEEL - 17" LONG

PART # FINISH
GWR5H-BC Bright Chrome

2" WALL MOUNT BRACKET

STEEL

Bracket Base is 3" W x 3-7/8" H
Hook is 1" H x 2 3/4" Projection

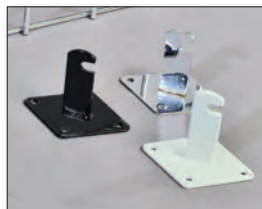

PART # FINISH
GW3-BC Bright Chrome
GW3-BK Black
GW3-WH White

USE #12 PANHEAD SCREWS

GRIDWALL & ACCESSORIES

WIRE BASKETS & WIRE SHELVES FOR GRIDWALL



**12" W x 6" D x 6" H
NARROW BASKET**

PART #	FINISH
GWB1266-BC	Bright Chrome
GWB1266-BK	Black



**12" W x 12" D x 8" H
DEEP BASKET**

PART #	FINISH
GWB12128-BC	Bright Chrome
GWB12128-BK	Black



**12" W x 12" D x 4" H
SMALL BASKET**

PART #	FINISH
GWB12124-BC	Bright Chrome
GWB12124-BK	Black



**24" W x 12" D x 4" H
SHALLOW BASKET**

PART #	FINISH
GWB12244-BC	Bright Chrome
GWB12244-BK	Black



**24" W x 5 3/4" D x 6 3/4" H
VIDEO BOOK SHELF**

PART #	FINISH
GW/VCS24-BK	Black



**15" x 24" SLANT SHELF
WITH FRONT LIP 60°**

PART #	FINISH
GW6-BC	Bright Chrome
GW6-BK	Black



**15" x 24" STRAIGHT SHELF
WITH FRONT LIP 90°**

PART #	FINISH
GW8-BC	Bright Chrome
GW8-BK	Black



24" x 24" TRIANGULAR SHELF

PART #	FINISH
GW5-BC	Bright Chrome
GW5-BK	Black

HANDBAR ACCESSORIES



**ADJUSTABLE GRIDWALL
SCARECROW**

PART #	FINISH
GW/T	Bright Chrome

(ADJ 20 1/2" - 30 3/4")

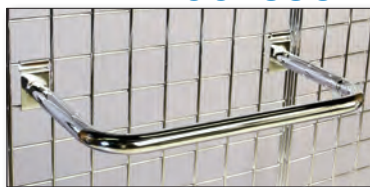

U SHAPED HANG RAIL

PART #	FINISH
GW/KHG681	Bright Chrome

Projects 12" out - 2' Long



HAT HOLDER

PART #	FINISH
GWHH-BK	Black
GWHH-BC	Bright Chrome

4 1/2" H x 8" Deep, 3" Ring

JOINERS & CONNECTORS



STEEL

Connects 2 Grip Panels
at 90° Angle

JOINER CLIP

PART #	FINISH
GW/CGW2-BC	Bright Chrome
GW/CBLK2-BK	Black

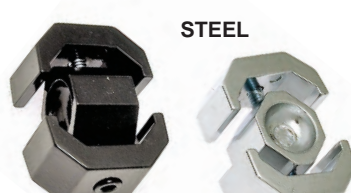

STEEL

Connects 4 Grip Panels
at 90° Angle

JOINER CLIP

PART #	FINISH
GW/CGW4-BC	Bright Chrome
GW/CBLK4-BK	Black



STEEL

FLUSH MOUNTING CLIP

PART #	FINISH
GW1-BC	Bright Chrome
GW1-BK	Black
GW1-WH	White

For securing panels to floor.
Clip is 11/16" W x 1" L with 1/4" Dia. Hole
Screw Size: #8 Pan Head Screws



STEEL

JOINER CLIP

PART #	FINISH
GW2-BC	Bright Chrome
GW2-BK	Black
GW2-WH	White

Joins grids for straight or angle position.
Screw Size: 1/4"-20 x 3/4"
Long Pan Head Screw

MERCHANDISING ESSENTIALS

UNIVERSAL SURFACE MOUNTED STANDARDS

New

- All standards have 1/2" slots on 1" centers
- Countersunk mounting screw holes are 9" apart

SINGLE SLOTTED

PART #	SIZE	FINISH
Medium Duty - .062 Thick Material		
SRD-SMD36-SZ	36" L x 11/16" W x 13/32" D	Satin Zinc
SRD-SMD48-SZ	48" L x 11/16" W x 13/32" D	Satin Zinc
SRD-SMD60-SZ	60" L x 11/16" W x 13/32" D	Satin Zinc
SRD-SMD72-SZ	72" L x 11/16" W x 13/32" D	Satin Zinc
SRD-SMD84-SZ	84" L x 11/16" W x 13/32" D	Satin Zinc
SRD-SMD96-CH	96" L x 11/16" W x 13/32" D	Chrome
Heavy Duty - .093 Thick Material		
SRD-SHD36-SZ	36" L x 11/16" W x 13/32" D	Satin Zinc
SRD-SHD48-SZ	48" L x 11/16" W x 13/32" D	Satin Zinc
SRD-SHD60-SZ	60" L x 11/16" W x 13/32" D	Satin Zinc
SRD-SHD72-SZ	72" L x 11/16" W x 13/32" D	Satin Zinc
SRD-SHD84-SZ	84" L x 11/16" W x 13/32" D	Satin Zinc
SRD-SHD96-SZ	96" L x 11/16" W x 13/32" D	Satin Zinc
SRD-SHD96-CH	96" L x 11/16" W x 13/32" D	Chrome
SRD-SHD120-CH	120" L x 11/16" W x 13/32" D	Chrome

Single Double

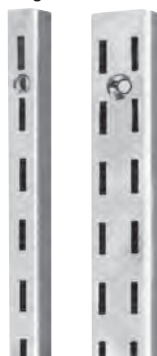

DOUBLE SLOTTED

PART #	SIZE	FINISH
Medium Duty - .062 Thick Material		
SRD-DMD36-SZ	36" L x 1/4" W x 1/2" D	Satin Zinc
SRD-DMD48-SZ	48" L x 1/4" W x 1/2" D	Satin Zinc
SRD-DMD60-SZ	60" L x 1/4" W x 1/2" D	Satin Zinc
SRD-DMD72-SZ	72" L x 1/4" W x 1/2" D	Satin Zinc
SRD-DMD84-SZ	84" L x 1/4" W x 1/2" D	Satin Zinc
SRD-DMD96-CH	96" L x 1/4" W x 1/2" D	Chrome
Heavy Duty - .093 Thick Material		
SRD-DHD36-SZ	36" L x 1/4" W x 1/2" D	Satin Zinc
SRD-DHD48-SZ	48" L x 1/4" W x 1/2" D	Satin Zinc
SRD-DHD60-SZ	60" L x 1/4" W x 1/2" D	Satin Zinc
SRD-DHD72-SZ	72" L x 1/4" W x 1/2" D	Satin Zinc
SRD-DHD84-SZ	84" L x 1/4" W x 1/2" D	Satin Zinc
SRD-DHD96-SZ	96" L x 1/4" W x 1/2" D	Satin Zinc
SRD-DHD96-CH	96" L x 1/4" W x 1/2" D	Chrome

STEEL SHELF BRACKETS **New**

- All steel & wood brackets work with all styles of standards listed above

PART #	DESCRIPTION	FINISH/ COLOR
Tap-In - .080 Thick Material		
6KB-BC	6" Long Bracket	Brite Chrome
6KB-AL	6" Long Bracket	Almond
6KB-BK	6" Long Bracket	Black
8KB-BC	8" Long Bracket	Brite Chrome
8KB-AL	8" Long Bracket	Almond
10KB-BC	10" Long Bracket	Brite Chrome
10KB-AL	10" Long Bracket	Almond
12KB-BC	12" Long Bracket	Brite Chrome
12KB-AL	12" Long Bracket	Almond
12KB-BK	12" Long Bracket	Black
12KB-SC	12" Long Bracket	Satin Chrome
14KB-BC	14" Long Bracket	Brite Chrome
14KB-AL	14" Long Bracket	Almond
14KB-WH	14" Long Bracket	White
14KB-BK	14" Long Bracket	Black
16KB-BK	16" Long Bracket	Black
16KB-WH	16" Long Bracket	White
16KB-BC	16" Long Bracket	Brite Chrome

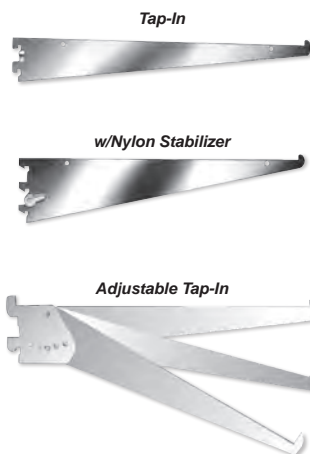

PART #	DESCRIPTION	FINISH/ COLOR
Heavy Duty Tap-In - .093 Thick Material		
12KBHD-BC	12" Long Bracket	Brite Chrome
14KBHD-BC	14" Long Bracket	Brite Chrome
w/Nylon Stabilizer - .090 Thick Material <i>Stabilizer allows for extra tight fit</i>		
10SKB-BC	10" Long Bracket	Brite Chrome
12SKB-BC	12" Long Bracket	Brite Chrome
14SKB-BC	14" Long Bracket	Brite Chrome
Adjustable Tap-In - .090 Thick Material <i>5 Spring Loaded Settings: Straight, 15, 30, 45 Down Slant & 15 Up Slant</i>		
10AKB-BC	10" Adjustable Bracket	Brite Chrome
12AKB-BC	12" Adjustable Bracket	Brite Chrome
14AKB-BC	14" Adjustable Bracket	Brite Chrome

WOOD SHELF BRACKETS **New**



16 Gauge Thick Material
Available in Left, Right & Center Positions

PART #	DESCRIPTION	FINISH
12WBL-SZ	12" Left Bracket	Satin Zinc
12WBR-SZ	12" Right Bracket	Satin Zinc
12WBC-SZ	12" Center Bracket	Satin Zinc
14WBL-SZ	14" Left Bracket	Satin Zinc
14WBR-SZ	14" Right Bracket	Satin Zinc
14WBC-SZ	14" Center Bracket	Satin Zinc

SEE NEXT PAGE FOR BRACKET ACCESSORIES

MERCHANDISING ESSENTIALS

BRACKETS ACCESSORIES

WORKS WITH BRACKETS AND STANDARDS FROM PREVIOUS PAGE

48" METAL SHELF SUPPORT

- Made of .093 thick rolled steel
- Gives added support to glass shelves



PART #	FINISH
SSPT-48	Zinc

REAR MOUNT BRACKET

- Holds 1" x 1" tubing



PART #	FINISH
SQ/SST	Chrome

KNIFE RESTS

- Fits 3/32" thick material



PART #	STYLE	FINISH
169-47-1110	Front	Clear Butyrate
169-47-1100	Center/Back	Clear Butyrate

GLASS SHELF RESTS

- Plated Metal



PART #	STYLE	FINISH
CLIP-1	Left	Bright Zinc
CLIP-2	Right	Bright Zinc
CLIP-3	Center	Bright Zinc

CLEAR ROUND SHELF BUMPER

- Rubber



PART #
BH100CL

RECTANGULAR SHELF BUMPERS

- Fits over brackets

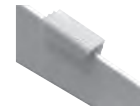

PART #	COLOR
SB109-WH	White
SB109-GY	Gray
SB109-TR	Translucent



STAINLESS STEEL SLOTTED STANDARDS



THIN SHELF STANDARD

- 430 Stainless Steel
- Measuring just under 1/2" W at 15/32"!
- 71-5/8" L



PART #	FINISH
Standards	
SPE-1820	Plain Steel
SPE-1820WT	White
Shelf Supports	
403 Stainless Steel	
SPE-FB20S	Plain Steel
SPE-FB20SWT	White
End Cap for Standards	
Elastomer (TPE)	
SPE-FC20	Light Gray



Shelf Supports



End Cap

NARROW SHELF STANDARD

- 430 Stainless Steel
- Unique slim profile
- 5/16" W x 71-21/32" L
- Easy to cut to desired length



PART #	FINISH
Standard	
SPN-1820	Satin
Shelf Support	
304 Stainless Steel	
SPN-15	Plain Steel
Cover for Shelf Support	
Elastomer	
SPN-15C	White
End Cap for Standard	
Polypropylene	
SPN-17EC	White



Shelf Support



End Cap

COVERED SHELF STANDARD

- 430 Stainless Steel
- 19/32" x 71-21/32" L
- Screw holes & slots are concealed when used with cover strips



PART #	FINISH
Standard	
SPW-1820	Satin
Cover Strip	
PVC Plastic	
SPW-CV1820-WT	White
SPW-CV1820-BR	Brown
Shelf Supports	
304 Stainless Steel Housing w/Elastomer Cover	
Load Capacity: 132 lbs./4 pcs.	
SPW-20-WT	White
SPW-20-BR	Brown
End Caps for Standard	
Polypropylene	
SPW-EC20-WT	White
SPW-EC20-BR	Brown



Shelf Supports w/Covers



End Caps



Cover Strips

GLASS FILLED NYLON HOOKS

- For 1/4" pegboard



HOOK		
PART #	SIZE	COLOR
DL-02BK	2"	Black
DL-02WH	2"	White
DL-02FG	2"	Fashion Gray
DL-04BK	4"	Black
DL-04WH	4"	White
DL-04FG	4"	Fashion Gray
DL-06BK	6"	Black
DL-06WH	6"	White
DL-06FG	6"	Fashion Gray

ECO PEG BOARD HOOKS

- Steel hook with white plastic back
- For 1/8" and 1/4" pegboard

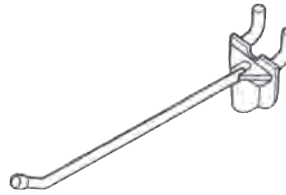

HOOK	
PART #	SIZE
EH-2	2"
EH-4	4"
EH-6	6"
EH-8	8"

HOOK TALKER

- Material: Clear PVC - 15 mil.
- Accepts adhesive UPC data labels
- Label size: 2-1/8" x 1-1/4"
- Fits hooks 1" on center



HOOK	
PART #	SIZE
HLH-45	4"-5"
HLH-67	6"-7"
HLH-89	8"-9"
HLH-10	10"-11"

PEGLOK™

- Material: Polyethylene
- For 1/4" pegboard

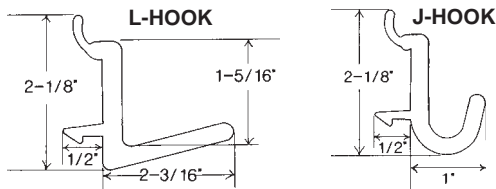

PART #	COLOR
L-HOOK-BK	Black
L-HOOK-WH	White
J-HOOK-WH	White

INVENTORY CONTROL CLIP

- Material: Polyethylene
- Control inventory inexpensively
- Keeps a nice full look
- Use on power panel to eliminate shifting during transit
- Sized to fit .15" to 1/4" diameter plastic or metal hooks
- Sold in bags of 100



PART #
ICC-10

VISION WARE REST

- Material: Clear Acrylic
- Fits 1/4" pegboard
- Eye glasses holder



PART #
R21-4

MERCHANDISING STRIPS

- Material: Polypropylene
- 12 Hook strip loads fast and easy
- Product "Loks" on for secure shipment
- Header measures 3" W x 1-3/8" H

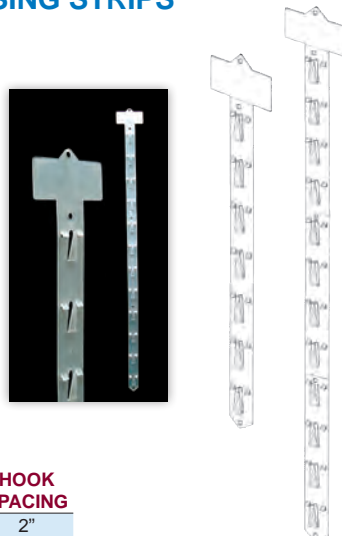

HOOK			
PART #	WIDTH	LENGTH	SPACING
MS-PL24	1-1/8"	24-1/2"	2"
MS-PL30	1-1/8"	30"	2-1/2"

S-HOOKS

- Material: Zinc Plated Steel
- Hang from shelf edge or wire fixtures
- Open ended for use with all merchandising
- .080" Zinc plated steel - 1-3/4" Long
- "Strip Hook Open Ended" and "Strip Hook Pinched"



PART #	TYPE
SH-50	Open
SH-75	Pinched

HEAVY DUTY/COMMERCIAL GRADE STEEL TUBING FOR HANGRAIL, DISPLAYS OR CLOSET APPLICATIONS

1" DIAMETER

For 1" & 1-1/16" Round Tubing

BRITE CHROME FINISH

RHR/OF "O" FLANGE RHR/UF "U" FLANGE

(SCREW HOLE DIA. = 1/4") USE #10 FLATHEAD SCREWS

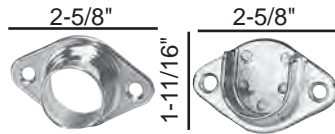

1" Dia.
x 14 Gauge

BRITE CHROME FINISH

PART # LENGTH

RHR/48	48"
RHR/60	60"
RHR/72	72"
RHR/96	96"

Concealed Round Closet Rod Flange for 1" Tubing



CHROME PLATED BRASS

PART #

S84-1000CF-BC

Connector for 1" Round Tubing

BRITE ZINC FINISH

PART #

RHR/CONN



1-1/4" DIAMETER

For 1-1/4" Round Tubing

BRITE CHROME FINISH

T21/OF "O" FLANGE T21/UF "U" FLANGE

(SCREW HOLE DIA. = .164") USE #6 PANHEAD SCREWS

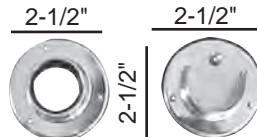

1-1/4" Dia.
x 14 Gauge

BRITE CHROME FINISH

PART #

T21-40-14-CHR-6

Concealed Round Closet Rod Flange for 1-1/4" Tubing



CHROME PLATED BRASS

PART #

S84-1140CF-BC

Outside Cover Sleeve
For 1" & 1-1/4" Diameter Tubing



Cover Sleeve

BLACK & WHITE

Rigid PVC - 5 ft. lengths

Inquire on custom lengths & colors

PART # DESCRIPTION

CS100BK	1" I.D. Black
CS100WH	1" I.D. White
CS125WH	1-1/4" I.D. White

ABS End Caps
For 1" & 1-1/4" O.D. X 14 Gauge



BLACK or CHROME

PART # O.D. COLOR

S60-3214CH	1"	Chrome
S53-3214BK	1"	Black
S53-4014BK	1-1/4"	Black

1" SQUARE STEEL TUBING & ACCESSORIES



1" x 16 Gauge

BRITE CHROME FINISH

PART # SIZE

SQ/60	60"
SQ/72	72"
SQ/96	96"

ABS End Caps
For 1" x 16 Gauge



BLACK

PART #

S50-3216BK

RECTANGULAR HANGRAIL/TUBING & ACCESSORIES



1/2" x 1/2"
x 16 Gauge

BRITE CHROME FINISH

PART # SIZE

RT/48	48"
RT/60	60"
RT/72	72"

Connector for Rectangular Tubing

BRITE ZINC PLATED

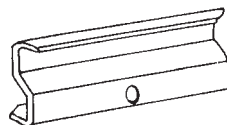

PART #

RT/CONN

Straight Out



12" Long, 1/2" x 1 1/2" tubular arm with flat end stop to fit 1/2" x 1 1/2" tubing.

RT/RSO

End Cap

METAL - CHROME



PART #

RT/END

FIXTURE & WALL BUMPER

FEATURES & BENEFITS:

- Profile matches Cartguard 1 for seamless transition from rigid to flexible products
- Made from a minimum of 91% pre consumer polycarbonate waste
- Contributes towards satisfying MR CREDIT 4-1 and MR CREDIT 4-2 under Leed.
- Exceeds Impact performance of High Impact PVC by 29% and ABS by 63%.
- 100% recyclable. Laser etched recycling symbol and resin ID code.
- 100% Chlorine free (PVC free, vinyl free)
- Does not emit hazardous dioxins if incinerated during waste disposal

Material: Polycarbonate

RIGID

GreenGuard1
GreenGuard2

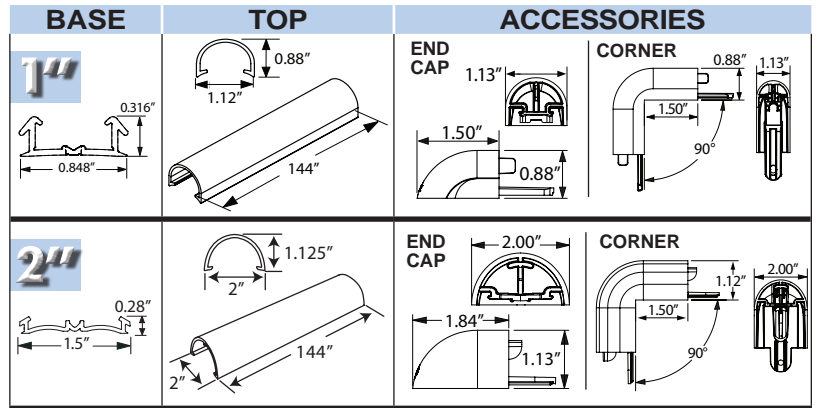

PART #	DESCRIPTION	LENGTH
GGT-10*	1" Top	12'
GGB-10-BK	1" Base	12'

PART #	DESCRIPTION	LENGTH
GGT-20*	2" Top	12'
GGB-20-BK	2" Base	12'

PART #	DESCRIPTION
GGE-10*	1" End Cap
GGC-10*	1" Corner

PART #	DESCRIPTION
GGE-20*	2" End Cap
GGC-20*	2" Corner

*Stock Colors:

401 Black PMS Black Hussmann 701, Kysor 85	111 Silver PMS 877C	101 Gray PMS 430C Hussmann 054	105 Steel PMS 425C	501 Red PMS 1797C Hussmann 715, Kysor 161	701 Blue PMS 293C	609 Putty PMS 452C Hussmann 078, Kysor 121	604 Light Caramel PMS 465C	601 Beige PMS 4685C
--	------------------------	--------------------------------------	-----------------------	---	----------------------	--	-------------------------------	------------------------

*Other Colors: Available to ship within 3-4 weeks

713 Deep Blue PMS 296C	732 Sapphire PMS 294C	562 Mango PMS 165C	602 Brown PMS 1545C	801 White PMS White Hussmann 700, Kysor 71
533 Raspberry PMS 216C	739 Majestic Purple PMS 2695C	310 Mellow Yellow PMS 1235C Hussmann 719	201 Green PMS 348C	

FIXTURE & WALL BUMPER

FEATURES & BENEFITS:

- Made from flexible PVC
- Works seamlessly with Greenguard1 for smooth transitions
- Designed to wrap around curved fixtures and cases
- Can complete a radius as small as 4"

Flexible

CartGuard1

CartGuard2

Material: Top = PVC
End Caps, Corner, Base = Polycarbonate

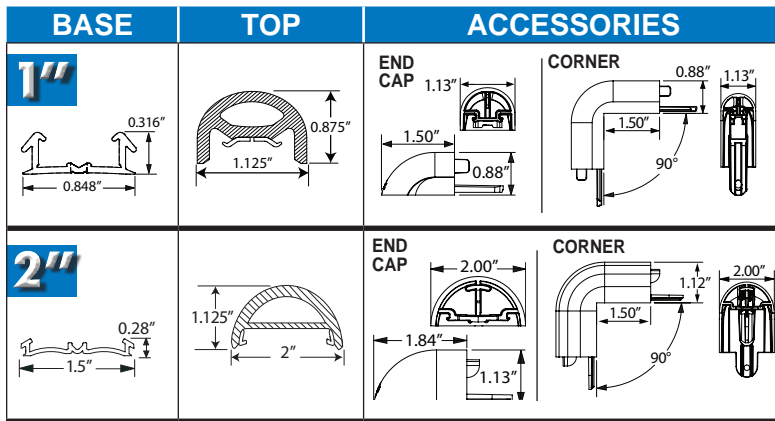

PART #	DESCRIPTION	LENGTH
CGT-10FLX-*	1" Top	72'
GGB-10-BK	1" Base	12'

NOTE: Min order for flexible is 12 ft. and must be ordered in 12 ft. increments

PART #	DESCRIPTION
GGE-10-*	1" End Cap
GGC-10-*	1" Corner

PART #	DESCRIPTION	LENGTH
CGT-20FLX-*	2" Top	72'
GGB-20-BK	2" Base	12'

NOTE: Min order for flexible is 12 ft. and must be ordered in 12 ft. increments

PART #	DESCRIPTION
GGE-20-*	2" End Cap
GGC-20-*	2" Corner

*Stock Colors:

401 Black PMS Black Hussmann 701, Kysor 85	111 Silver PMS 877C	101 Gray PMS 430C Hussmann 054	105 Steel PMS 425C	501 Red PMS 1797C Hussmann 715, Kysor 161	701 Blue PMS 293C	609 Putty PMS 452C Hussmann 078, Kysor 121	604 Light Caramel PMS 465C	601 Beige PMS 4685C
---	-------------------------------	---	------------------------------	--	-----------------------------	---	--------------------------------------	-------------------------------

*Other Colors: Available to ship within 3-4 weeks

713 Deep Blue PMS 296C	732 Sapphire PMS 294C	562 Mango PMS 165C	602 Brown PMS 1545C	801 White PMS White Hussmann 700, Kysor71
533 Raspberry PMS 216C	739 Majestic Purple PMS 2695C	310 Mellow Yellow PMS 1235C Hussmann 719	201 Green PMS 348C	

FIXTURE & WALL BUMPER

FEATURES & BENEFITS:

- Damage protection for fixtures, merchandisers, walls and vestibules.
- Decorative ribbing helps hide scuff marks

Material: PVC

RIGID

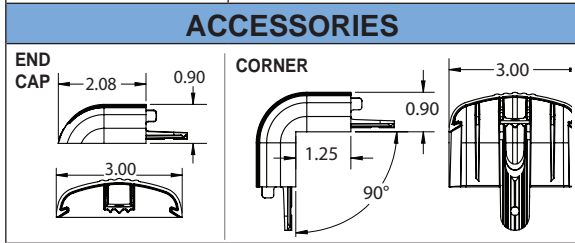
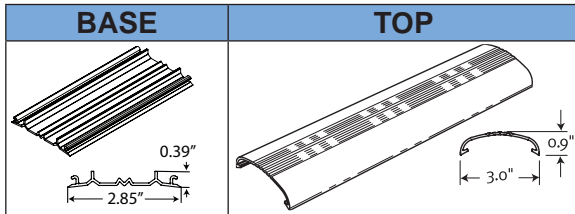

***FOR COLORS, SEE COLOR SWATCHES ON PAGE 125.**

CartGuard35

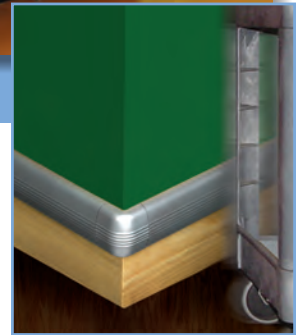

PART #	DESCRIPTION	LENGTH
CGT-35*	3" Top	12'
CGB-35-BK	3" Base	12'

PART #	DESCRIPTION
CGE-35*	3" End Cap
CGC-35*	3" Corner

FEATURES & BENEFITS:

- Vertical corner protection
- Textured finish helps hide scuff marks

RIGID

Material: PVC



CartGuardV

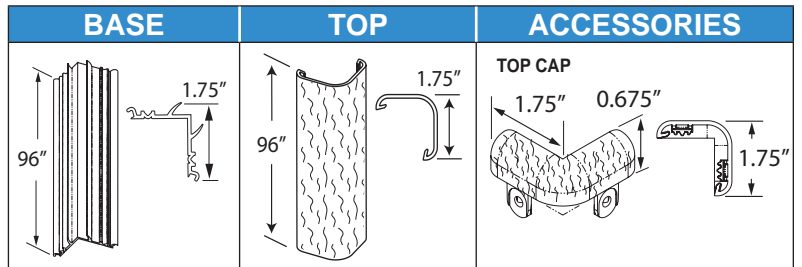

PART #	DESCRIPTION	LENGTH
CGT-V175*	1-3/4" Vertical Trim	8'
CGB-V175-BK	1-3/4" Vertical Base	8'

PART #	DESCRIPTION
CGE-V175*	1-3/4" Vertical Top Cap

*Stock Colors:

401 Black PMS Black Hussmann 701, Kysor 85	111 Silver PMS 877C	101 Gray PMS 430C Hussmann 054
--	------------------------	--------------------------------------

*Other Colors:

Available to ship within 3-4 weeks

562 Mango PMS 165C	801 White PMS White Hussmann 700, Kysor 71	533 Raspberry PMS 216C
739 Majestic Purple PMS 2695C	310 Mellow Yellow PMS 1235C Hussmann 719	201 Green PMS 348C

IMPACT PROTECTION SYSTEM

Impact Protection can be found in a variety of settings, from hospitals and nursing homes, to colleges, offices, casinos, hotels and warehouses. OPI's handrails, wall guards, corner guards and door/frame protection come in a multitude of colors, profiles and materials. Choose from stainless steel, aluminum, wood, PVC or combinations of materials to match the protection level your environment requires while at the same time complementing décor.

COLOR CHART

Add appropriate color code to part number.



#301 Linen White #5 Gray #1 Black



#411 Pumice #361 Pearl #193 Wheat #21 Cappuccino



#676 Dover White #718 Silkworm #29 Blue Ice #113 Toffee



#555 Porcelain #313 Champagne #2 Ivory #648 Monterey



#379 Mojave Sand #176 Taupe #483 Harvard Gray #682 Khaki Brown



#289 Pearl Gray #263 Pale Yellow #569 Saffron #204 Shell

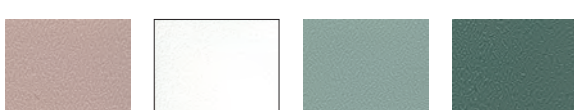

#381 Dawn #10 White #376 Pale Jade #377 Teal

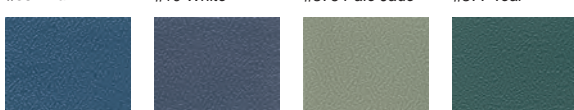

#382 Stormy Blue #369 Blue Fog #373 English Rose #265 Windsor Blue

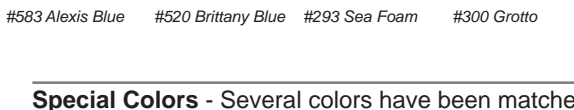

#490 Blue Bird #583 Alexis Blue #520 Brittany Blue #293 Sea Foam

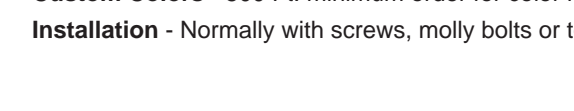

#300 Grotto #156 Hunter Green #380 Cordovan #4 Brown



#22 Wodlands #694 Cafe' Au Lait #554 Misson White #541 White Sand #370 Eggshell

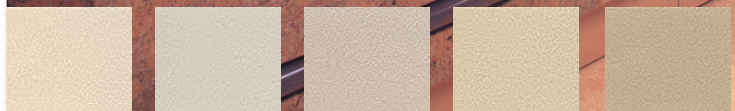

#497 Chablis #238 Bone #268 Doeskin #148 Desert Sand #3 Tan

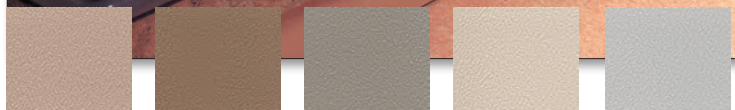

#486 Caisson #288 Mocha #297 Chinchilla #385 Beige Desert #210 Silver Gray



#304 Victorian Rose #494 Lavender Heather #359 Ginger Spice #366 Soft Peach #269 Ecru



#381 Dawn #10 White #376 Pale Jade #377 Teal #382 Stormy Blue

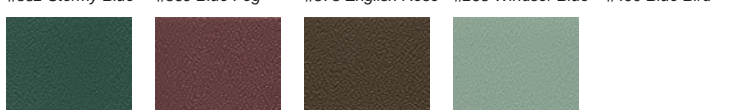

#369 Blue Fog #373 English Rose #265 Windsor Blue #490 Blue Bird #583 Alexis Blue

Special Colors - Several colors have been matched - please inquire for colors, costs & delivery.

Custom Colors - 500 Ft. minimum order for color matching. Color & setup charges are on a per run basis. Please inquire.

Installation - Normally with screws, molly bolts or toggle bolts. Most sold separately.

NOTE: Due to fading, discoloration & paper aging, the colors on this page may vary from the actual colors. Please request samples before placing your order for color accuracy.

IMPACT PROTECTION SYSTEM

2-15/16" to 6" WIDE WALL GUARDS

FOR COLORS SEE PAGE 127

MATERIAL: Textured Vinyl with Aluminum Retainer • 12 Ft. Lengths

CLASS A FIRE RATED

Accessories: Molded PVC end caps and outside corners are available.

Select profiles offer an accent strip, continuous cushioned bumper and inside corner.

Refer to chart below for more details.

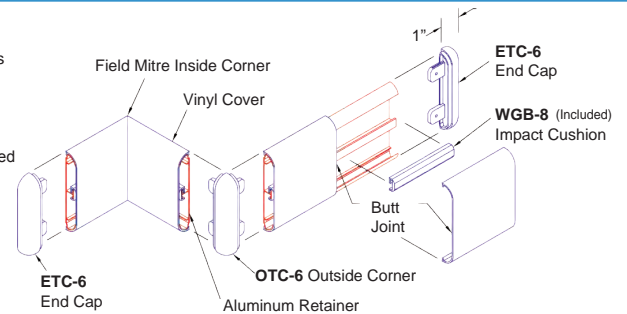
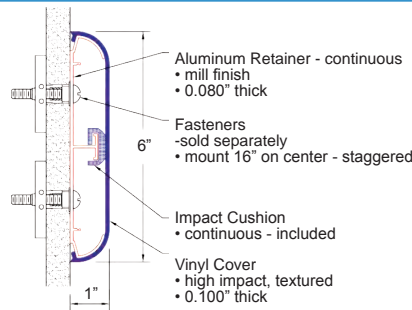
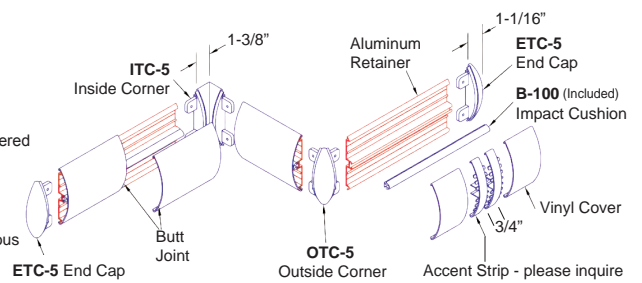
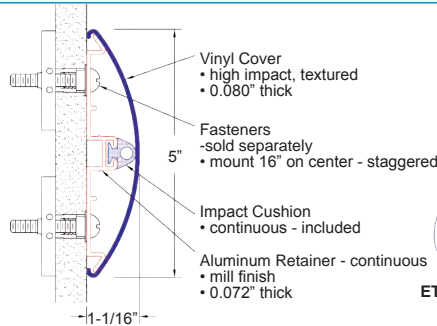
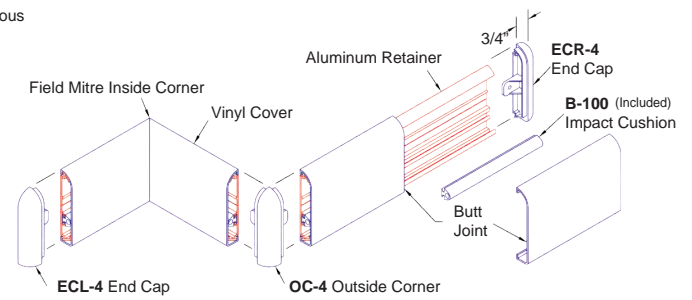
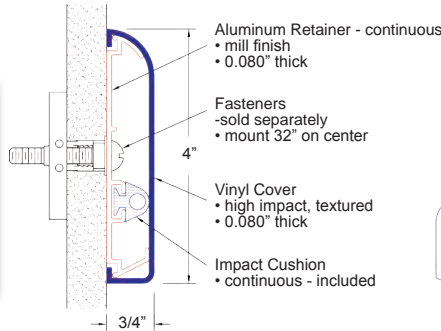
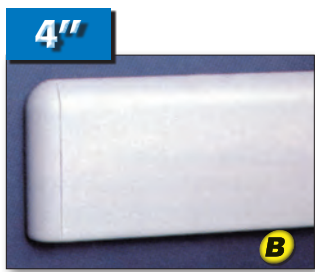
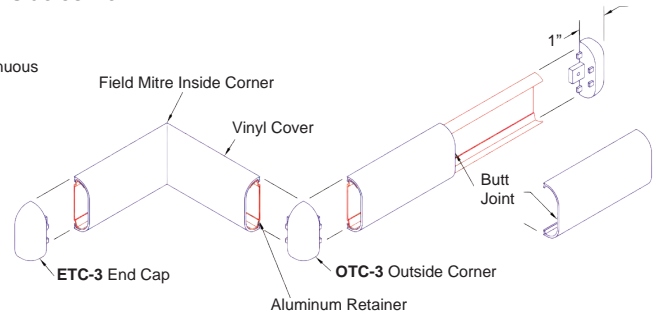
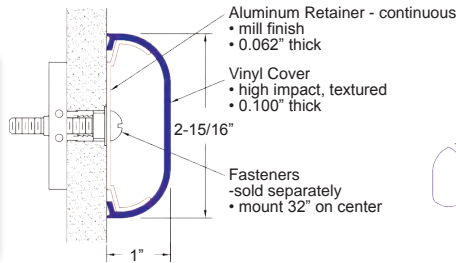

STYLE	WALL GUARDS			END CAPS	OUTSIDE CORNERS	INSIDE CORNERS
	PART #	SIZE	PROTECTION LEVEL	PART #	PART #	PART #
A	WG-3-	2-15/16"	Medium	ETC-3-	OTC-3-	-
B	WG-4-	4"	Medium to Heavy	ECL-4- (left)	OTC-4-	-
				ECR-4- (right)		
C	WG-5-	5"	Medium to Heavy	ETC-5-	OTC-5-	ITC-5-
D	WG-6-	6"		ETC-6-	OTC-6-	-

IMPACT PROTECTION SYSTEM

7-3/4" to 8" WIDE WALL GUARDS

FOR COLORS SEE PAGE 127

MATERIAL: Textured Vinyl with Aluminum Retainer • 12 Ft. Lengths

CLASS A FIRE RATED

Accessories: Molded PVC end caps and outside corners are available.

Select profiles offer an accent strip, continuous cushioned bumper and inside corner.

Refer to chart below for more details.

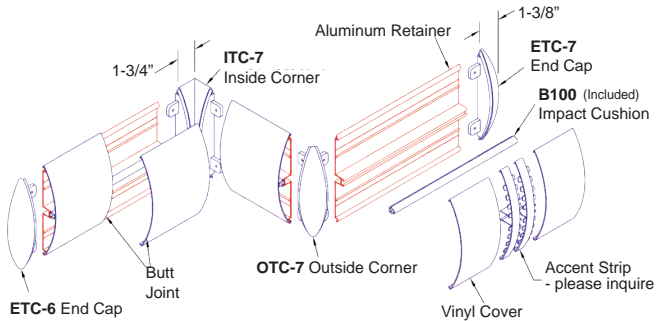
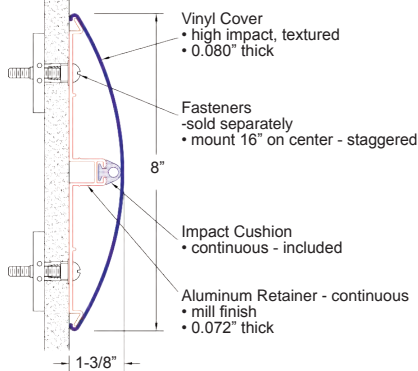
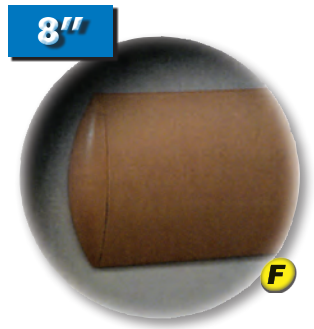
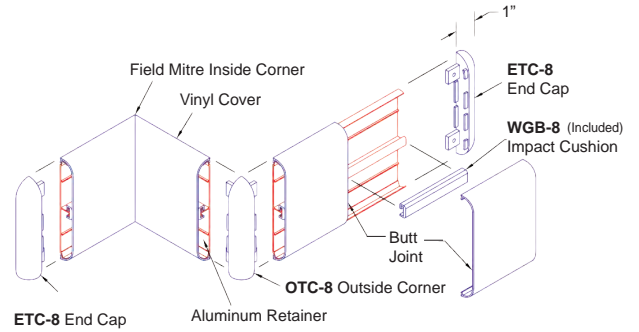
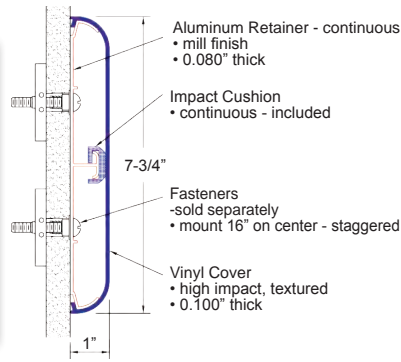

WALL GUARDS				END CAPS	OUTSIDE CORNERS	INSIDE CORNERS
STYLE	PART #	SIZE	PROTECTION LEVEL	PART #	PART #	PART #
E	WG-8-	7-3/4"	Medium to Heavy	ETC-8-	OTC-8-	-
F	WG-7-	8"	Heavy	ETC-7-	OTC-7-	ITC-7-

WALL GUARDS

MATERIAL: Clear Lexan/Polycarbonate • 8 Ft. Lengths

CLASS A FIRE RATED



Pre-drilled hole for #6 fasteners
• approximately 3" from each end,
then approximately 18" o.c.

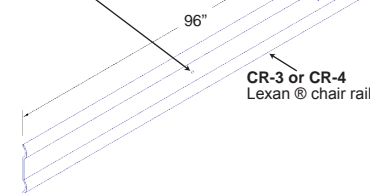
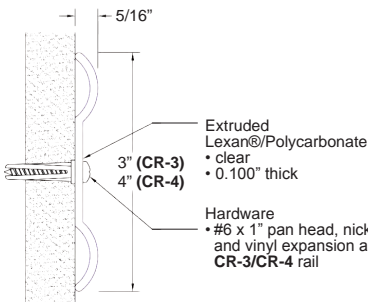

PART #	HEIGHT	PROTECTION LEVEL
CR-3-132	3"	Medium to Heavy
CR-4-132	4"	Heavy

MOLDED CORNER BUMPER

MATERIAL: Molded Flexible Vinyl • 8" Corner

Good for low temperature environments. Excellent abrasion resistance. Not to be used where temperatures exceed 150°F.

Stock Colors (Quick Ship): Black, Tan



Smooth Finish

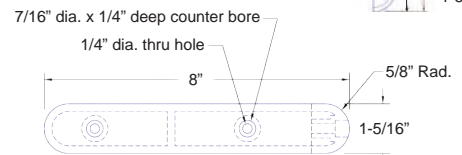
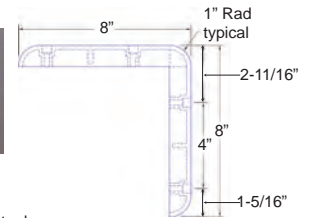

PART #
EB-8

IMPACT PROTECTION SYSTEM

CLEAR POLYCARBONATE CORNER GUARDS

MATERIAL: Polycarbonate

UL 94 V-2 FLAMMABILITY

The CG-16 is un-drilled and comes with brad nails.

All other profiles are drilled with countersunk holes and include #6 x 1" oval head sheet metal screws.

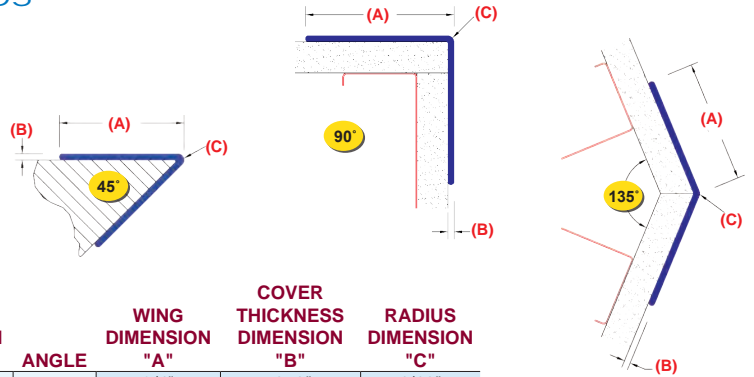
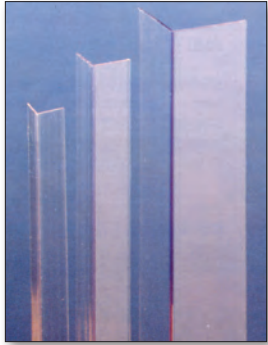

PART #	LENGTH	PROTECTION LEVEL	ANGLE	WING DIMENSION "A"	COVER THICKNESS DIMENSION "B"	RADIUS DIMENSION "C"
CG-16-132-	4 = 4 Ft.	Medium	90°	3/4"	.050"	1/16"
CG-17-132-				1-1/8"	.075"	1/8"
CG-24-132-				2"	.085"	1/8"
CG-18-132-	8 = 8 Ft.		135°	2-1/2"	.100"	1/8"
CG-25-132-				3"	.110"	1/8"
CG-19-132-				2-1/2"	.100"	1/8"
CG-22-132-		45°	2-1/2"	.100"	1/8"	

CG-12 , CG-13, CG-14 & CG-34 CORNER GUARD

MATERIAL: Textured Vinyl Cover, Available with or without Peel & Stick Adhesive

Drilled options available, *please inquire*

****FOR COLORS SEE PAGE 127**

CLASS A FIRE RATING



WITH ADHESIVE								
PART #	LENGTH	PROTECTION LEVEL	ANGLE	WING DIMENSION "A"	VINYL COVER THICKNESS DIMENSION "B"	RADIUS DIMENSION "C"	OVERALL PROJECTION DIMENSION "D"	
CGT-34-**-4	4 Ft.	Medium to Heavy	90°	3/4"	.080"	1/8"	.080"	
CGT-34-**-8	8 Ft.			1-1/2"	.080"	1/8"	.080"	
CGT-34-**-12	12 Ft.			3"	.093"	3/16"	.093"	
CGT-12-**-4	4 Ft.			4"	.093"	3/16"	.093"	
CGT-12-**-8	8 Ft.							
CGT-12-**-12	12 Ft.							
CGT-13-**-4	4 Ft.							
CGT-13-**-8	8 Ft.							
CGT-13-**-12	12 Ft.							
CGT-14-**-4	4 Ft.							
CGT-14-**-8	8 Ft.							
CGT-14-**-12	12 Ft.							

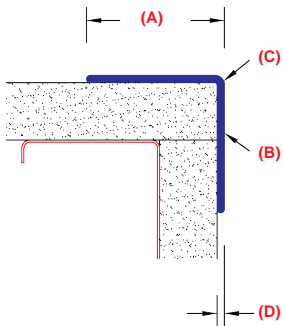

WITHOUT ADHESIVE								
PART #	LENGTH	PROTECTION LEVEL	ANGLE	WING DIMENSION "A"	VINYL COVER THICKNESS DIMENSION "B"	RADIUS DIMENSION "C"	OVERALL PROJECTION DIMENSION "D"	
CGU-34-**-4	4 Ft.	Medium to Heavy	90°	3/4"	.080"	1/8"	.080"	
CGU-34-**-8	8 Ft.			1-1/2"	.080"	1/8"	.080"	
CGU-34-**-12	12 Ft.			3"	.093"	3/16"	.093"	
CGU-12-**-4	4 Ft.			4"	.093"	3/16"	.093"	
CGU-12-**-8	8 Ft.							
CGU-12-**-12	12 Ft.							
CGU-13-**-4	4 Ft.							
CGU-13-**-8	8 Ft.							
CGU-13-**-12	12 Ft.							
CGU-14-**-4	4 Ft.							
CGU-14-**-8	8 Ft.							
CGU-14-**-12	12 Ft.							

IMPACT PROTECTION SYSTEM

#4 SATIN FINISH 304 GRADE STAINLESS STEEL CORNER GUARD

Ideal for lab and/or foot service environments!

Installs easily with adhesive (*sold separately*). Drilled options available, *please inquire*.



PART #	LENGTH	PROTECTION LEVEL	ANGLE	WING DIMENSION "A"	VINYL COVER THICKNESS DIMENSION "B"	RADIUS DIMENSION "C"	
CG-50-4	4 Ft.	Heavy	90°	3-1/2"	16 GA. (059")	1/8"	
CG-50-8	8 Ft.			2"			
CG-51-4	4 Ft.			1"			
CG-51-8	8 Ft.			3-1/2"			
CG-52-4	4 Ft.			135°		3-1/2"	3/4"
CG-52-8	8 Ft.					3-1/2"	1/8"
CG-55-4	4 Ft.		3-1/2"			3/4"	
CG-55-8	8 Ft.		3-1/2"			1/8"	
CG-60-4	4 Ft.						
CG-60-8	8 Ft.						
CG-65-4	4 Ft.						
CG-65-8	8 Ft.						

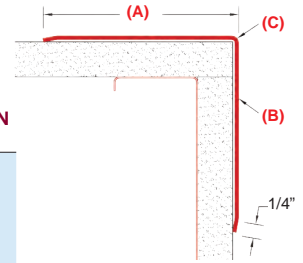

CG-10 & CG-20 CORNER GUARD

MATERIAL: Textured Vinyl Cover with Aluminum Retainer

CLASS A FIRE RATING

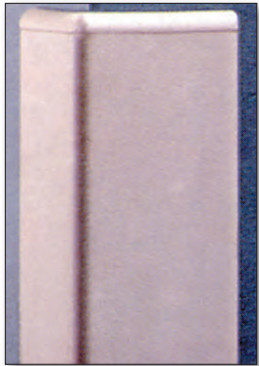

PART #	LENGTH *	PROTECTION LEVEL	ANGLE	WING DIMENSION "A"	VINYL COVER THICKNESS DIMENSION "B"
CG-10-**-4	4 Ft.	Medium to Heavy	90°	3"	.100"
CG-10-**-8	8 Ft.				
CG-10-**-9	9 Ft.				
CG-20-**-4	4 Ft.			2"	.085"
CG-20-**-8	8 Ft.				
CG-20-**-9	9 Ft.				

* 10 Ft. & 12 Ft. lengths are available - please inquire

TOP/BOTTOM CLOSURE CAPS	
PART #	USE WITH
TC-10-**-	CG-10-
TC-20-**-	CG-20-

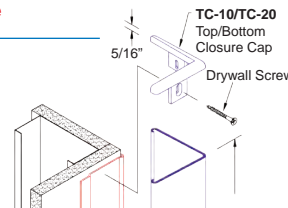

**FOR COLORS SEE PAGE 127

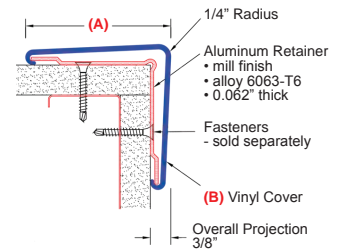

WALL GUARDS: ACCENT RAILS

MATERIAL: High Impact Vinyl Cover with Aluminum Retainer

CLASS A FIRE RATED

Molded PVC end caps and outside corners are available.

These versatile shapes can be used as a chair rail, bumper rail, or just to provide a color accent.

Suggested to mount to every other stud, approximately 32".

PART #	LENGTH	PROTECTION LEVEL	COVER FACE WIDTH DIMENSION "A"	COVER THICKNESS DIMENSION "B"	OVERALL PROJECTION DIMENSION "C"
EB-25-	12 Ft.	Medium	1-1/8"	.100"	1-1/16"
EBR-30-			2"	.085"	1-1/8"
WG-22-			2"	.100"	1-3/4"

END CAPS	
PART #	USE WITH
EB-26-	EB-25
EB-31-	EBR-30
EC-22-	WG-22

OUTSIDE CORNERS	
PART #	USE WITH
EB-27-	EB-25-
EB-32-	EBR-30-
OC-22-	WG-22-

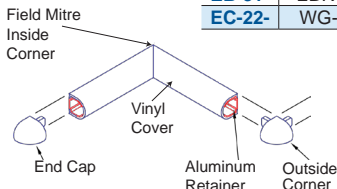

FOR COLORS SEE PAGE 127

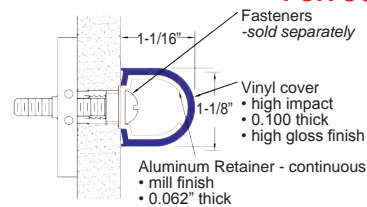

EB-25-

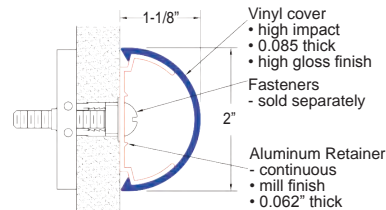

EBR-30-

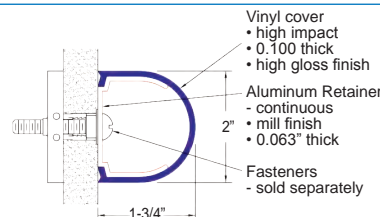

WG-22-

