

2014



SIGN COMPONENTS

SIGN COMPONENTS

Pgs. 132-188



Designer (Die Cast Zamac)



STANDOFFS

Premium No Drill (Steel)

Premium (Stainless Steel)



Frames (Front Loading Aluminum)



Cable Shelving



Sign Banner Holders



Snap Ease Sign/Banner Holder



GRAPHIC HOLDERS

Floor Mount Stands

Compact A-Frame Sign Holder



Curved Free Standing Graphic Holders



Folding Brochure Holders



MERCHANDISING ESSENTIALS

Ceiling Accessories

Roto Clip



Light Boxes (LED Crystal)

BROCHURE POCKETS	155	Clamps - Clamp It	160-162	Cone Topped Carbon Steel	139
CABLE SHELVING & SIGNAGE HARDWARE		Classic Banner Stand	164	Designer Diecast Zamac	139
Ceiling Mount Suspended Signage Kit	176	Compact A Frame Sign Holders	164	Desktop Stainless Steel	139
Channel Mount Ceiling Kit	178, 185	Easels (Aluminum)	165	Eco Aluminum	136
Channel Mount Floor to Ceiling Kit	178	Floor to Ceiling - Clamp It	160	Eco Invisible Polycarbonate	140
Components & Optional Accessories	177	Free Standing - Clamp It	160	Eco Lite Stainless Steel	135
Cubes (Acrylic)	180	Hang It Up	169-171	Eco Solid Stainless Steel Barrels	136
Floor to Ceiling Kits	176, 184	Stand Up	166-168	Eco Solid Stainless Steel	136
FOGA® Modular Exhibition Display System	178	GRIPS FOR SIGNAGE	138	Eco Steel/Aluminum No Drill	134
LED Crystal Light Box	188	LIGHT BOXES (LED)		Euro Solid Carbon Steel	137
LED MR16 Rod	187	LED Crystal Light Boxes	152, 188	Premium Aluminum	133
Multi Use Signage Kits	184	Snap-Ease Front Loading Aluminum	153	LED	709
Shelves (Acrylic)	179-180	LITERATURE POCKETS	154	Premium Stainless Steel	133
Sign Holders (Acrylic)	179	MAGNETIC POCKETS (Clear Vinyl)	155	Premium Steel No Drill	134
Wall to Floor Kits	175	MERCHANDISING ESSENTIALS		Premium Steel	132
Wall to Wall Kits	175	Aluminum Stretch Frames	158	Slotted Solid Brass	138
CEILING MOUNT HANG IT SIGN SYSTEM	186	Brochure Holders (Folding)	159	Square Acrylic UV Standoffs	138
COUNTER CARDS (Universal)	155	Ceiling Grid Hooks, Clips & Accessories	156	Square Steel or Aluminum	137
EASEL BACKS (Self Stick)	155	Sign Holders / Roto Clips	157-158	STANDOFFS ACCESSORIES	
FRAME PROFILES		MIRROR MOULDINGS	172-173	UV Standoffs Accessories	138
Front Loading Plastic	146	PICTURE MOULDINGS	172-173	WALL MOUNT SIGNAGE CAPS	
Plastic Frame Mouldings	146	SHEET PROTECTORS	154	Eco Stainless Steel	135
Quick Grip Framing System	145	SIGN / BANNER HOLDERS		Premium Aluminum	133
Snap-Ease Front Loading Aluminum	149	Channels (Assorted Materials)	142-144	Premium Steel	132
FRAMES		Klemmfix	144	WALL MOUNT SIGNAGE KITS	186
Flip Frames	148	Snap-Ease Aluminum Hanging System	147	WALL SIGN HOLDER (Stick-It)	154
Flip Through Frame Displays	148	Snap-Ease Sign Kits	147	WINDOW GRAPHIC KITS (Cable Mount)	
Snap-Ease Front Loading Aluminum	150-151	STANDOFFS		Deluxe	182-183
GRAPHICS HOLDERS		Caps (Cap It Off & Button)	141	Economy	181
"L" "M" "C" Floor Mount Stands	163	Casper Invisible Polycarbonate & Brass	140	WINDOW SIGN HOLDER (Stick-It)	154

SEE PAGES 1007-1023 FOR A - Z INDEX

PREMIUM STEEL SERIES

MATERIAL = SOLID CARBON STEEL
HOLDS PANEL MATERIAL UP TO 1/2"

PRODUCT FEATURES:

- Heavyweight, durable construction
- Most variety of sizes & finishes
- Tamper resistant Flat Cap - 1/4-20 thread
- Screws and anchors included
- 2.5mm Hex Key included (One per order)



PREMIUM MOUNTING DESIGN



Anchor and screw **THREADED MOUNTING PLATE** to wall

Screw **BARREL** to threaded mounting plate



Screw in attached sign and fasten with **TAMPER RESISTANT FLAT CAP w/HEX KEY**

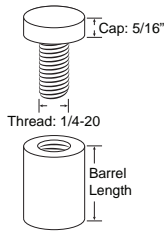

Finishes available in:

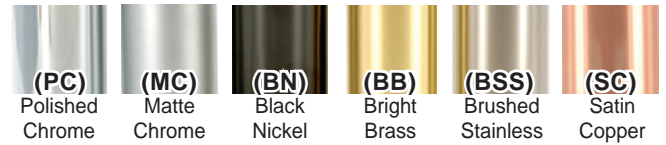

3/4" DIAMETER

PART #	BARREL LENGTH
STD-2424-*	3/4"
STD-2432-*	1"
STD-2448-*	1-1/2"
STD-24128-*	4"

1-1/4" DIAMETER

PART #	BARREL LENGTH
STD-4024-*	3/4"
STD-4032-*	1"
STD-4048-*	1-1/2"
STD-40128-*	4"
STD-40192-*	6"

Please visit page 301 for our wall anchor selections

PREMIUM STEEL WALL MOUNT SIGNAGE CAPS

MATERIAL = STEEL

Finishes available:

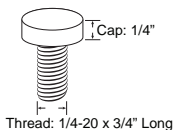

3/4" DIAMETER CAPS

PART #	FINISH
STD-24CAP-PC	Polished Chrome
STD-24CAP-MC	Matte Chrome
STD-24CAP-BN	Black Nickel
STD-24CAP-BB	Bright Brass
STD-24CAP-BSS	Brushed Stainless

1-1/4" DIAMETER CAPS

PART #	FINISH
STD-40CAP-PC	Polished Chrome
STD-40CAP-MC	Matte Chrome
STD-40CAP-BN	Black Nickel
STD-40CAP-BB	Bright Brass
STD-40CAP-BSS	Brushed Stainless

INSERT NUTS



No Flange
I-NUT250



With Flange
I-NUT250F

Thread: 1/4-20

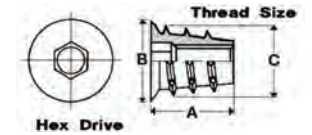

DIMENSIONS

PART#	A	B	C
I-NUT250	.512"	-	.453"
I-NUT250F	.512"	.492"	.461"

PART#

I-NUT250
I-NUT250F

PREMIUM ALUMINUM SERIES

MATERIAL = ALUMINUM
HOLDS PANEL MATERIAL UP TO 1/2"

PRODUCT FEATURES:

- Lightweight, durable aluminum construction
- Will not rust!
- Flat Cap - 1/4-20 thread
- Screws and anchors included



Finishes available:

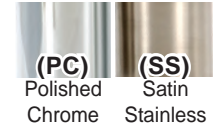

(PC) Polished Chrome
(SS) Satin Stainless



TAMPER RESISTANT w/ HEX KEY
(See pg. 132)

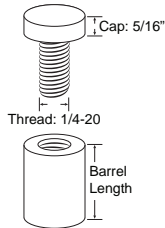

5/8" DIAMETER

PART #	BARREL LENGTH
STDA-2020-SS	5/8"
STDA-2032-SS	1"
STDA-2048-SS	1-1/2"
STDA-2064-SS	2"
STDA-2096-SS	3"
STDA-20128-SS	4"

3/4" DIAMETER

PART #	BARREL LENGTH
STDA-2424-*	3/4"
STDA-2432-*	1"
STDA-2448-*	1-1/2"
STDA-24128-*	4"

1-1/4" DIAMETER

PART #	BARREL LENGTH
STDA-4024-*	3/4"
STDA-4032-*	1"
STDA-4048-*	1-1/2"
STDA-40128-*	4"

PREMIUM ALUMINUM WALL MOUNT SIGNAGE CAPS

MATERIAL = ALUMINUM

Finishes available:



POLISHED CHROME POLISHED STAINLESS

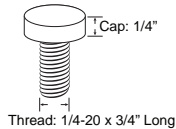

3/4" DIAMETER CAPS

PART #	FINISH
STDA-24CAP-PC	Polished Chrome
STDA-24CAP-PS	Polished Stainless

1-1/4" DIAMETER CAPS

PART #	FINISH
STDA-40CAP-PC	Polished Chrome
STDA-40CAP-PS	Polished Stainless

INSERT NUTS



No Flange I-NUT250 With Flange I-NUT250F

DIMENSIONS

PART #	A	B	C
I-NUT250	.512"	-	.453"
I-NUT250F	.512"	.492"	.461"

PREMIUM STAINLESS SERIES

MATERIAL = STAINLESS STEEL
HOLDS PANEL MATERIAL UP TO 1/2"

PRODUCT FEATURES:

- 316 grade steel
- Marine grade - Will not rust!
- Flat Cap - 1/4-20 thread
- Screws and anchors included



3/4" DIAMETER

PART #	BARREL LENGTH
STD-2424-SS	3/4"
STD-2432-SS	1"
STD-2448-SS	1-1/2"
STD-24128-SS	4"

1-1/4" DIAMETER

PART #	BARREL LENGTH
STD-4024-SS	3/4"
STD-4032-SS	1"
STD-4048-SS	1-1/2"
STD-40128-SS	4"



TAMPER RESISTANT w/ HEX KEY
(See pg. 132)

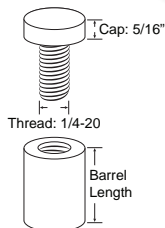

PREMIUM NO DRILL SERIES

MATERIAL = SOLID STEEL
HOLDS PANEL MATERIAL UP TO 1/2"

EASY EDGE



PRODUCT FEATURES:

- Heavyweight, durable steel construction
- The easiest standoff to install on the market today
- Rounded cap
- Screws and anchors included

Finishes available:

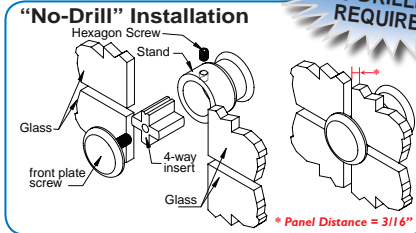

4-WAY

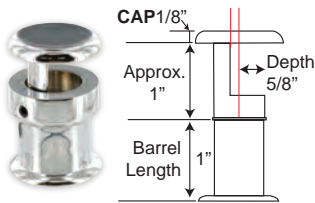

1" DIAMETER

PART #	FINISH
STD-EDGE-PC	Polished Chrome
STD-EDGE-MC	Matte Chrome

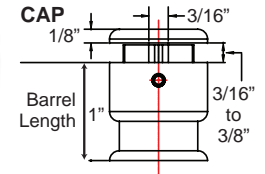
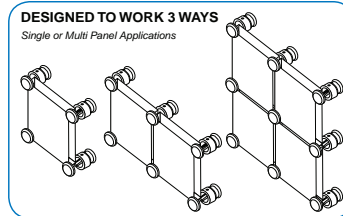

1" DIAMETER

PART #	FINISH
STD-4WAY-PC	Polished Chrome
STD-4WAY-MC	Matte Chrome

ECO SOLID "EASY MOUNT" NO DRILL STANDOFF SERIES

MATERIAL = STAINLESS STEEL & ALUMINUM CONSTRUCTION
HOLDS PANEL MATERIAL UP TO 5/16"

PRODUCT FEATURES:

- No drilling required
- Will hold multiple signs
- Screws and anchors included
- 2.5mm Hex Key included (One per order)

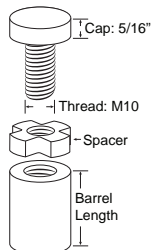

Finishes available:



1" DIAMETER

PART #	BARREL LENGTH
STDE-SP-3224-*	3/4"
STDE-SP-3232-*	1"
STDE-SP-3248-*	1-1/2"
STDE-SP-3264-*	2"

ECO-LITE SERIES

MATERIAL = 202 STAINLESS STEEL
HOLDS PANEL MATERIAL UP TO 1/2"

PRODUCT FEATURES:

- Lightweight, but **GREAT!**
- Stainless Steel Construction
- Saves time & money because so easy to install
- Brushed Stainless Finish
- Flat Cap - M10 thread
- Screws and anchors included

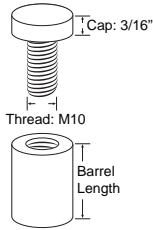

SUPER SAVER



EASY MOUNTING DESIGN



1/2" DIAMETER «

PART #	BARREL LENGTH
^STDE-1313-BSS	1/2"
STDE-1324-BSS	3/4"
STDE-1332-BSS	1"
STDE-1348-BSS	1-1/2"
STDE-1364-BSS	2"
STDE-1396-BSS	3"
STDE-13128-BSS	4"

^ 1/2" Barrel Holds Up To 1/4" Material
« 1/2" Diameter has M8 thread

1" DIAMETER

PART #	BARREL LENGTH
STDE-3224-BSS	3/4"
STDE-3232-BSS	1"
STDE-3248-BSS	1-1/2"
STDE-3264-BSS	2"
STDE-3296-BSS	3"
STDE-32128-BSS	4"
STDE-32192-BSS	6"

5/8" DIAMETER

PART #	BARREL LENGTH
STDE-2024-BSS	3/4"
STDE-2032-BSS	1"
STDE-2048-BSS	1-1/2"
STDE-2064-BSS	2"
STDE-2096-BSS	3"
STDE-20128-BSS	4"

1-1/4" DIAMETER

PART #	BARREL LENGTH
STDE4024-BSS	3/4"
STDE-4032-BSS	1"
STDE-4048-BSS	1-1/2"
STDE-4064-BSS	2"
STDE-4096-BSS	3"
STDE-40128-BSS	4"
STDE-40192-BSS	6"

3/4" DIAMETER

PART #	BARREL LENGTH
STDE-2424-BSS	3/4"
STDE-2432-BSS	1"
STDE-2448-BSS	1-1/2"
STDE-2464-BSS	2"
STDE-2496-BSS	3"
STDE-24128-BSS	4"

1-1/2" DIAMETER

PART #	BARREL LENGTH
STDE-4824-BSS	3/4"
STDE-4832-BSS	1"
STDE-4848-BSS	1-1/2"
STDE-4864-BSS	2"
STDE-4896-BSS	3"
STDE-48128-BSS	4"
STDE-48192-BSS	6"

ECO WALL MOUNT SIGNAGE CAPS

MATERIAL = 201 STAINLESS STEEL

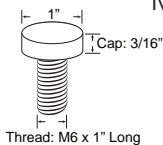

1" DIAMETER CAPS

PART #	FINISH
STDE-32CAP-BSS	Brushed Stainless
STDE-32CAP-PSS	Polished Stainless

Finishes available:



ECO SOLID SERIES

MATERIAL = 201 STAINLESS STEEL
HOLDS PANEL MATERIAL UP TO 1/2"

PRODUCT FEATURES:

- Solid Stainless Steel Construction
- Saves time & money because so easy to install
- Flat Cap - M10 thread
- Screws and anchors included

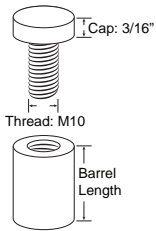
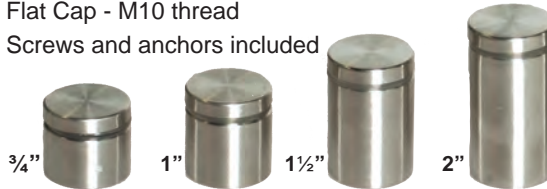

Finishes available:



3/4" DIAMETER

PART #	BARREL LENGTH
STDE-S2424-*	3/4"
STDE-S2432-*	1"
STDE-S2448-*	1-1/2"
STDE-S2464-*	2"

ECO SOLID BARRELS



PRODUCT FEATURES:

- Works with 1" diameter "ECO" solid standoffs
- Brushed Stainless finish



PART #	BARREL LENGTH	THREAD LENGTH
STDE-32BAR1	1"	
STDE-64BAR1	2"	1"
STDE-96BAR1	3"	
STDE-32BAR2	1"	
STDE-64BAR2	2"	1-1/2"
STDE-96BAR2	3"	

1" DIAMETER

PART #	BARREL LENGTH
STDE-S3224-*	3/4"
STDE-S3232-*	1"
STDE-S3248-*	1-1/2"
STDE-S3264-*	2"

1-1/4" DIAMETER

PART #	BARREL LENGTH
STDE-S4024-*	3/4"
STDE-S4032-*	1"
STDE-S4048-*	1-1/2"
STDE-S4064-*	2"

ECO ALUMINUM STANDOFFS

MATERIAL = ALUMINUM
HOLDS PANEL MATERIAL UP TO 1/2"

PRODUCT FEATURES:

- Lightweight, durable aluminum construction
- Will not rust
- Flat Cap - M10 thread
- So easy to install - saves time & money
- Screws and anchors included

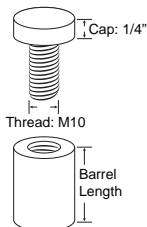

Finishes available:



1/2" DIAMETER

PART #	BARREL LENGTH
^STDE-A1313-*	1/2"
STDE-A1319-*	3/4"

^ 1/2" Barrel Holds Up To 1/4" Material
« 1/2" Diameter has M8 thread

3/4" DIAMETER

PART #	BARREL LENGTH
STDE-A2424-*	3/4"
STDE-A2432-*	1"

1" DIAMETER

PART #	BARREL LENGTH
STDE-A3224-*	3/4"
STDE-A3232-*	1"

SQUARE STANDOFFS

MATERIAL = SOLID CARBON STEEL or ALUMINUM
HOLDS PANEL MATERIAL UP TO 1/2"



PRODUCT FEATURES:

- Heavyweight, durable construction
- Modern look complements any design
- Flat Cap - 1/4-20 thread
- Screws and anchors included

*For Our LED Standoffs,
 See Page 709*

Finishes available:

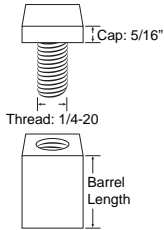
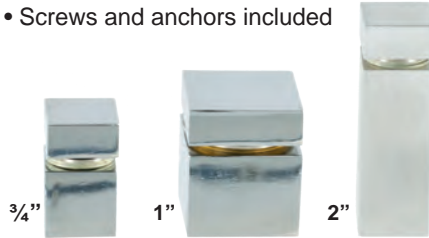
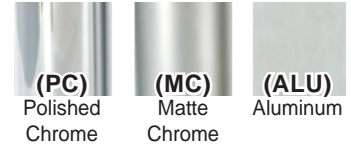

3/4" x 3/4" SQUARE

1-1/4" x 1-1/4" DIAMETER

PART #	BARREL LENGTH
STD-SQ2424-*	3/4"
STD-SQ2432-*	1"
STD-SQ2464-*	2"

PART #	BARREL LENGTH
STD-SQ4024-*	3/4"
STD-SQ4032-*	1"
STD-SQ4064-*	2"

EURO STANDOFF SERIES

MATERIAL = SOLID CARBON STEEL

PRODUCT FEATURES:

- Heavyweight, durable steel construction
- Euro Style
- Round Cap - 1/4-20 thread
- Screws and anchors included

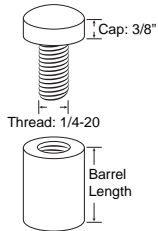
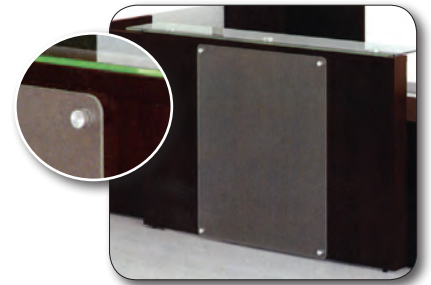

Finishes available:

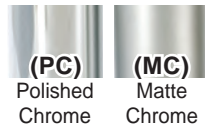

1/2" DIAMETER

1-1/2" DIAMETER

PART #	BARREL LENGTH	ACCEPTS PANEL THICKNESS UP TO:
STD-1313-*	1/2"	3/16"
STD-1319-*	3/4"	5/16"

PART #	BARREL LENGTH	ACCEPTS PANEL THICKNESS UP TO:
STD-4040-*	1-1/2"	1/2"
STD-4080-*	3"	1/2"

SLOTTED STANDOFFS

MATERIAL = SOLID BRASS
HOLDS PANEL MATERIAL UP TO 1/2"

PRODUCT FEATURES:

- Can be mounted either vertically or horizontally
- Perfect for holding partition panels, signage or shelving
- No drilling required
- 3 sizes available to accommodate panels up to 1/2" thickness
- Screws included
- 2.5mm Hex Key included (One per order)

**TAMPER
RESISTANT
w/ HEX KEY**



1-1/4" DIAMETER

Finishes available:

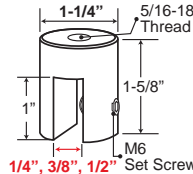
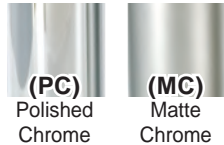

PART #	PANEL SIZE
STD-SL14-*	1/4"
STD-SL38-*	3/8"
STD-SL12-*	1/2"



GRIPS FOR SIGNAGE

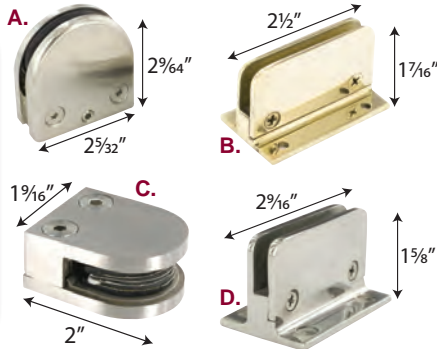

PART #	ACCEPTABLE MATERIAL	FINISH	MATERIAL
A SSFZ-618F-SC	3/16" - 3/8"	Brushed Stainless Steel	Zamac
B S83-108F-BR	1/4"	Polished Brass	Brass
C SSF-618FADJ-SC	1/4" - 5/16"	Brushed Stainless Steel	304 Grade Satin Stainless Steel
D S83-108F-CH	1/4"	Polished Stainless Steel	Stainless Steel

SCREWS

PART #	FINISH	SIZE
SCR-8750FHZ	Zinc	#8 x 3/4"
SCR-8750PHZ	Zinc	#8 x 3/4"

CRYSTAL CLEAR SQUARE UV STANDOFFS

MATERIAL = ACRYLIC

PRODUCT FEATURES:

- Virtually invisible when installed
- Can be used outdoors
- Other sizes available - please inquire

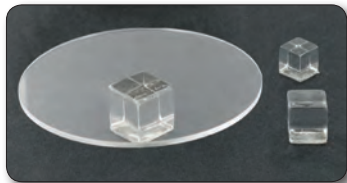

New

PART #	SIZE
STD-CUBE-500	1/2"
STD-CUBE-750	3/4"
STD-CUBE-1000	1"

Requires UV adhesive & gun

UV GLUE

PRODUCT FEATURES:

- High Viscosity
- Suitable for bonding glass to metal
- Cures under UV light at a wavelength 365-400 nm
- Cures crystal clear

PART #	SIZE
UV-ADH-10	10 ml
UV-ADH-50	50 ml

UV ACCESSORIES

UV CURING FLASH LIGHT

PRODUCT FEATURES:

- 1 watt of power for adhesive curing
- UV wavelength: 365-400 nm
- Cures UV adhesive at a distance of approximately 3/8" (1 cm) in 60 seconds
- 3 AAA batteries required

PART #
UV-FL-1W



UV CURING LAMP

PRODUCT FEATURES:

- 13 watts of power for adhesive curing
- UV wavelength: 365 nm
- Cures UV adhesive at a distance of approximately 3/8" (1 cm) in 60 seconds
- 110V

PART #
UV-LAMP-13W



New

CONE TOPPED STANDOFFS

MATERIAL = CARBON STEEL
HOLDS PANEL MATERIAL UP TO 1/2"

New



PRODUCT FEATURES:

- Heavyweight, durable construction
- Modern look complements any design
- Tamper resistant Flat Cap - 1/4-20 thread
- Screws and anchors included
- 2.5mm Hex Key included (One per order)

Finishes available:



3/4" DIAMETER

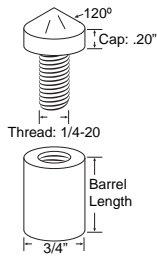

Please visit page 301 for our wall anchor selections

PART #	BARREL LENGTH
STD-C2424-PC	3/4"
STD-C2432-PC	1"
STD-C2448-PC	1-1/2"
STD-C2464-PC	2"
STD-C24128-PC	4"

DESKTOP STANDOFFS

MATERIAL = 304 GRADE STAINLESS STEEL
HOLDS 5/16" PANEL MATERIAL

New

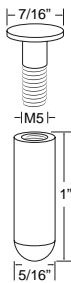

PRODUCT FEATURES:

- Perfect for nameplates and small desktop signs
- Sleek modern look
- Quality stainless steel construction
- 5mm (.20") Drill hole size

Finishes available:



PART #
STD-D32-SS



DESIGNER STANDOFFS

MATERIAL = DIE CAST ZAMAC
HOLDS PANEL MATERIAL UP TO 1/2"

New



TAMPER RESISTANT w/ HEX KEY



PRODUCT FEATURES:

- Lightweight, durable construction
- Euro style round cap pops into place inside barrel
- Screws and anchors included
- Tamper resistant with Hex Key included (One per order)

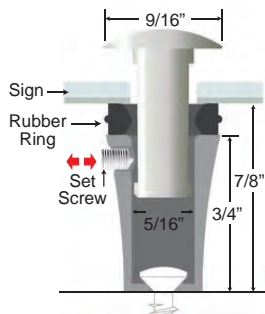

Finishes available:



PART #	POLISHED CHROME (*PC)	MATTE CHROME (*MC)	BRIGHT BRASS (*BB)	SATIN COPPER (*SC)	BRUSHED STAINLESS (*BSS)	ANTIQUE BRASS (*AB)
STD-D1828-*						

CASPER INVISIBLE STANDOFFS

MATERIAL = POLYCARBONATE & BRASS

New

PRODUCT FEATURES:

- NO SCREWS VISIBLE ON THE SIGN FRONT
- Removable
- Can be used outdoors
- Quick & Easy to use
- Sold in set of 4

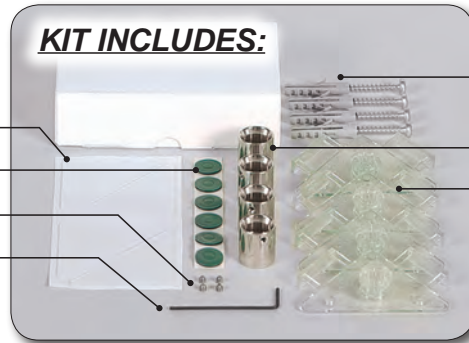

- KIT INCLUDES:**
- Adhesives
 - Washers
 - Set Screws
 - Hex Key

- Screws & Anchors
- Barrels
- Fasteners w/Removable Mounting Guides

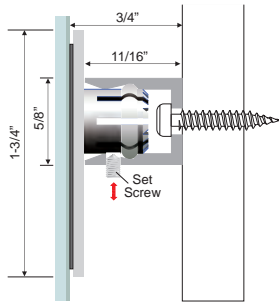
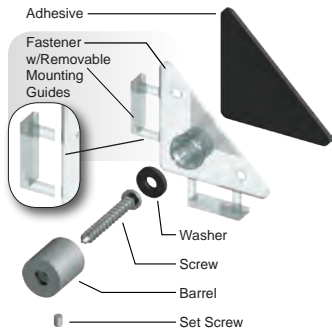

PART #
STDI-CASPER

Replacement heads available - please inquire

“ECO” INVISIBLE STANDOFFS

MATERIAL = POLYCARBONATE

New

PRODUCT FEATURES:

- NO SCREWS VISIBLE ON THE LETTER OR SIGN FRONT
- Can be used outdoors
- Quick & Easy to use
- For letters & signs weighing up to .75 lbs.
- Available with or without adhesive

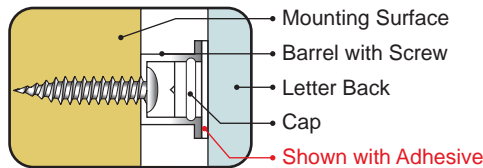
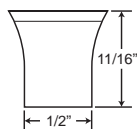
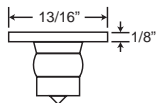

 Please visit page 301 for our wall anchor selections



PART #	DESCRIPTION
STDI-6875	Invisible Standoff
STDI-6875-A	Invisible Standoff with Adhesive
SCR-8100PHZ	#8 x 1" Long Zinc Pan Head Phillips Screw
STD-ANCHOR	Wall Anchor for #8 Screw

STANDOFFS FOR SIGNAGE & DISPLAY

CAPS

"CAP IT OFF"

MATERIAL = POLYPROPYLENE

PRODUCT FEATURES:

- Sold in sets of 4. Each Kit includes 4 caps, 4 bases, 4 #8 x 1" screws & 4 anchors
- All caps are made from polypropylene
- All metallic finishes are vacuum plated
- Polypropylene caps are UV stabilized for outdoor use (**does not** apply to metallics)

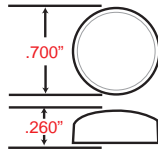

N = NEW COLOR

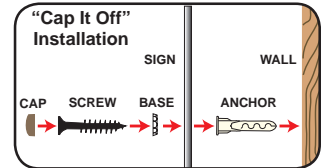

10 New Colors To Choose From!

PART #	FINISH	PART #	FINISH	PART #	FINISH	PART #	FINISH
STDC-24-BK	Black	STDC-24-GR	Green	STDC-24-LP	Light Pink	STDC-24-SC	Satin Chrome
STDC-24-WH	White	STDC-24-BL	Blue	STDC-24-RD	Red	STDC-24-CH	Bright Chrome
STDC-24-BR	Brown	STDC-24-OR	Orange	STDC-24-TQ	Turquoise	STDC-24-BRS	Bright Brass
STDC-24-BE	Beige	STDC-24-PL	Purple	STDC-24-YW	Yellow	STDC-24-SCOP	Satin Copper
STDC-24-LG	Light Gray	STDC-24-DB	Dark Blue	STDC-24-FG	Forest Green	STDC-24-COP	Bright Copper

Many other colors available -1000 pc. minimum. Please Inquire.

"CAP IT OFF"

MATERIAL = STEEL
FINISH - BRUSHED STAINLESS

PRODUCT FEATURES:

- Must be purchased in sets of 4

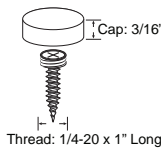

PART #	DIAMETER
STD-32AMC-BSS	1"
STD-40AMC-BSS	1-1/4"
STD-48AMC-BSS	1-1/2"

1/2" DIAMETER BUTTON CAPS FOR SIGNAGE

MATERIAL = CHROME PLATED SOLID BRASS
FOR PANEL THICKNESS UP TO 1/2"

New

PRODUCT FEATURES:

- Used to make "Sandwich" style signs
- Can be used outdoors
- Tightens with Hex Key included (One per order)
- Requires .20" drill hole size

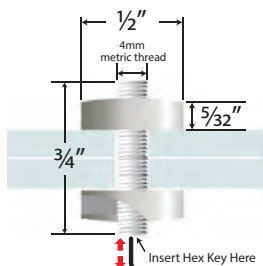

Finishes available:



PART #	FINISH
STD-13CAPSET-PC	Polished Chrome
STD-13CAPSET-MC	Matte Chrome

SIGN / BANNER HOLDERS

- An easy & affordable way to emphasize brands & your marketing message.
- Channels can easily be cut to size to accommodate a variety of banner widths.
- All channels can be used as a top & bottom rail.



142F-

PRODUCT FEATURES:

- Material: Styrolux
- Flared legs for easy graphic insertion

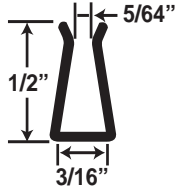

PART #	COLOR	LENGTH
142F-CL	Clear	12'
142F-BK	Black	12'
142F-WH	White	12'



670-A-

PRODUCT FEATURES:

- Material: Styrolux
- Classic universal clip design

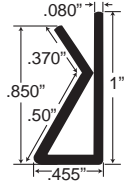

PART #	COLOR	LENGTH
670-A-BK	Black	8'
670-A-WH	White	8'



HS-447- "Super Clamp"

PRODUCT FEATURES:

- Material: PVC
- Each 4' length piece comes with 6 hanging hardware (BH-788-H) to hang banner onto the wall or from the ceiling (see ceiling clips on page 156)

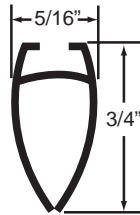

PART #	COLOR	LENGTH
HS-447-CL	Clear	4'
HS-447-BK	Black	4'
HS-447-WH	White	4'



130- "Banner Clamp"

PRODUCT FEATURES:

- Material: Clear PVC or Black & White Styrene

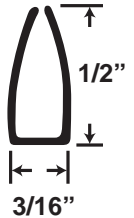

PART #	COLOR	*LENGTH
130-CL-*	Clear	(*8) = 8 ft.
130-BK-*	Black	(*10) = 10 ft.
130-WH-*	White	

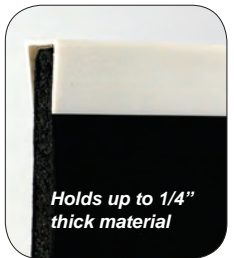

131- "Clamp It"

PRODUCT FEATURES:

- Material: Clear PVC or Black & White Styrene

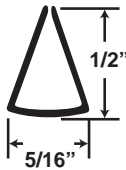

PART #	COLOR	*LENGTH
131-CL-*	Clear	(*8) = 8 ft.
131-BK-*	Black	(*10) = 10 ft.
131-WH-*	White	



2326- "Banner Channel"

PRODUCT FEATURES:

- Material: Black ABS with high gloss film on the front of the profile

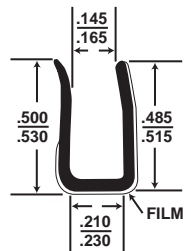

PART #	COLOR	LENGTH
2326-BK	Black	12'



1059- "Banner Channel"

PRODUCT FEATURES:

- Material: Rigid PVC

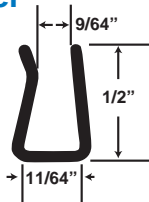

PART #	COLOR	LENGTH
1059-CL	Clear	12'



HS-2010- "The Great Gripper"

PRODUCT FEATURES:

- Material: PVC
- Each 8' length piece comes with 8 hanging hardware (BH-788-H) to hang banner onto the wall or from the ceiling (see ceiling clips on page 156)



PART #	COLOR	LENGTH
HS-2010-CL	Clear	8'

SIGN / BANNER HOLDERS

- An easy & affordable way to emphasize brands & your marketing message.
- Channels can easily be cut to size to accommodate a variety of banner widths.
 - All channels can be used as a top & bottom rail.

PFLF-1200-

PRODUCT FEATURES:

- Material: Dual Durometer PVC
- With or without adhesive

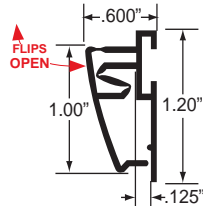

PART #	*COLOR	LENGTH
PFLF-1200-*	(*WH) = White (*BK) = Black	12'
PFLF-1200A-*	(*SL) = Silver	12'

PFLF-1040-

PRODUCT FEATURES:

- Material: Dual Durometer PVC
- With or without adhesive

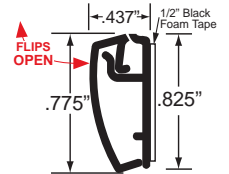

PART #	*COLOR	LENGTH
PFLF-1040-*	(*WH) = White (*BK) = Black	12'
PFLF-1040A-*	(*SL) = Silver	12'

BH-788- "Banner Holder" w/Snap Action

New

PRODUCT FEATURES:

- Material: Styrene
- Contoured shape allows for 2 sided graphics
- Easy mount channel for hanging hardware (BH-788-H), hang banner onto the wall or from the ceiling

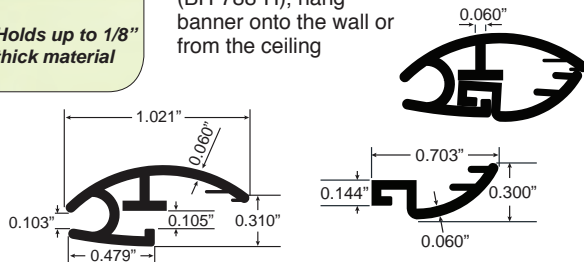
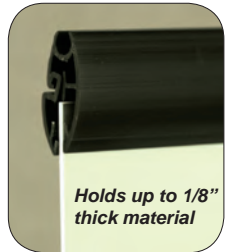

PART #	COLOR	LENGTH
BH-788-BK	Black	8'
BH-788-WH	White	8'

2799- "Mini Snap"

New

PRODUCT FEATURES:

- Material: Rigid PVC
- Clear rubber based film tape for wall mounting

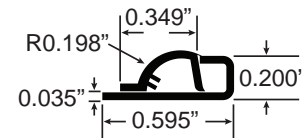

PART #	COLOR	LENGTH
2799-BK	Black	8'
2799-WH	White	8'

BH-788-H- "Universal Hanger"

New

PRODUCT FEATURES:

- Material: Clear Polyethylene
- Easily slides into the BH-788- "Banner Holder", HS-2010 "The Great Gripper" and HS-447- "Mini Snap"



Fits into channels up to 1/4" wide

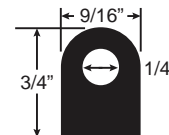

PART #	COLOR
BH-788-H	Clear

SIGN BANNER HOLDERS

“KLEMMFIX” SIGN HOLDERS

*A quick & easy way to install and replace signs.
Simply snap open, insert material & close.
No notching or stapling required.*

Available In Black, White & Clear PVC • 8 Ft. Lengths

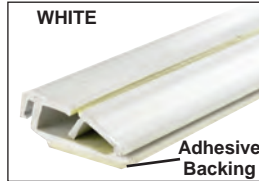

KLEMMFIX 18

PRODUCT SPECIFICATIONS:

- Suitable for paper thickness up to .04 inch.
- Stocked with & without adhesive backing.
- Hooks are available for hanging applications.

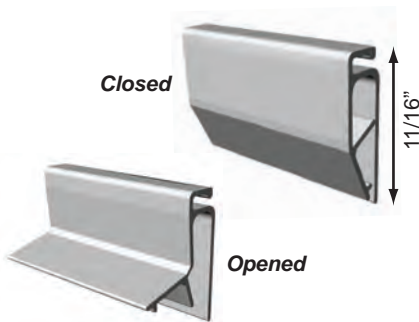

PART #	COLOR
Without Adhesive Backing	
3000-18BK	Black
3000-18WH	White
3000-18CL	Clear

With Adhesive Backing

3000-18BK-T	Black
3000-18WH-T	White
3000-18CL-T	Clear

KLEMMFIX 28

PRODUCT SPECIFICATIONS:

- Suitable for paper thickness up to .08 inch.
- Hooks are available for hanging applications.

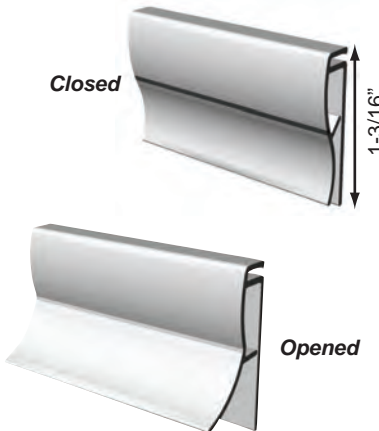

PART #	COLOR
3000-28BK	Black
3000-28WH	White
3000-28CL	Clear

KLEMMFIX 36

PRODUCT SPECIFICATIONS:

- Suitable for paper thickness up to .04 inch.
- Hooks are available for hanging applications.
- End caps are also available in black or white to give the finishing touch.

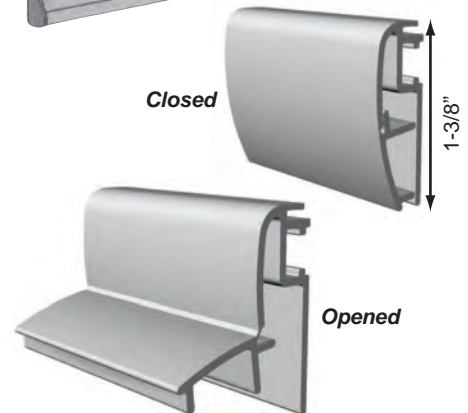

PART #	COLOR
3002-36BK	Black
3002-36WH	White

END CAPS For Klemfix 36



PART #	COLOR
3003-END-BK	Black
3003-END-WH	White

HANGING CLIPS

For Klemfix
18, 28 & 36



PART #	COLOR
3001-PH-BK	Black
3001-PH-WH	White
3001-PH-CL	Clear

Cut to Size and Simply Assemble



QUICK GRIP FRAMING SYSTEM

ALUMINUM & PVC FRAME PROFILES • LENGTHS: 8 FT.

An affordable way to make “Flip Open” frames in a variety of sizes and colors.

2 ASSEMBLY METHODS TO CHOOSE FROM!

Rounded Corner saves time!

Easy to install when frame assembled with corners!



Mitred Corner saves money!

When profile mitred, then no need to spend extra money on corners!



PRODUCT FEATURES:

★ Easy to use! Simply position your hinge to the backboard of your choice & staple down. Then, slide your corner into the end of your cut frame profile & slide that onto your hinges. If profiles are mitred, then slide on the hinge.

Frame Opened

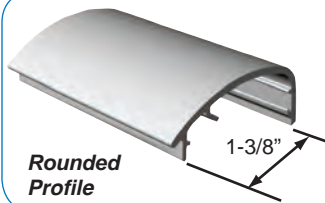

2 PROFILES TO CHOOSE FROM!

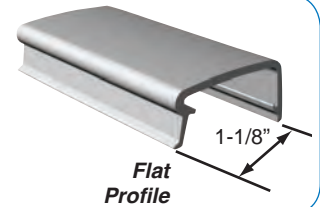

“STOCK COLORS”

★ UV stabilized PVC or clear anodized aluminum frame profiles. Other colors available on a per order basis: Blue, green or yellow. Can color match any color. Minimums apply, please inquire.



BLACK



WHITE



RED

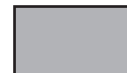

GREY

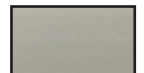

CLEAR ANODIZED ALUMINUM

“ROUNDED CORNERS”

- Available in UV stabilized plastic and chrome plated PVC.
- Slides directly into frame extrusion.
- No tools or cutting required.
- *Chrome works with Aluminum only.*



“THE HINGE”

★ Unique & patented “Hinge” aids in the ease of use, because it does not require connecting corners & spring clips like typical front loading frames.

- Available in black polypropylene only.
- Must use two hinges for each side.
- It is recommended to use one hinge every 2 ft.



PROFILES

ROUNDED PART #	FLAT PART #	COLOR
35-5000-AL	28-5000-AL	Aluminum
35-5000-BK	28-5000-BK	Black
35-5000-GRY	28-5000-GRY	Gray
35-5000-RED	N/A	Red
35-5000-WH	28-5000-WH	White

CORNERS

ROUNDED PART #	FLAT PART #	COLOR
35-5100-CH	28-5100-CH	Chrome
35-5100-BK	28-5100-BK	Black
35-5100-GRY	28-5100-GRY	Gray
35-5100-RED	N/A	Red
35-5100-WH	28-5100-WH	White

“THE HINGE”

PART #

HINGE

FRONT LOADING PLASTIC FRAME PROFILES

These plastic profiles can be easily cut & mitered to a variety of frame sizes. The flip open & snap close design will allow you to change graphics without disassembling the whole unit!



8 FT. LENGTHS w/ADHESIVE
HIGH GLOSS BLACK (BK) & POLISHED CHROME MYLAR (CH)

• Material: PVC

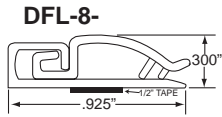

PART #	DESCRIPTION
DFL-8-BK	High gloss black-2 piece frame
DFL-8-CH	Chrome mylar-wrap-2 piece PVC frame

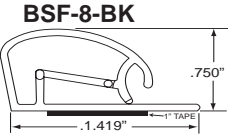
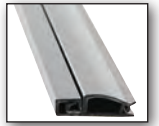

PART #	DESCRIPTION
BSF-8-BK	Black bullnose snap frame



12 FT. LENGTHS
WHITE (*WH), BLACK (*BK), SILVER (*SL)

• Material: Dual Durometer PVC

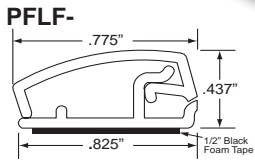

PART #	DESCRIPTION
PFLF-1040-*	w/o Adhesive
PFLF-1040A-*	w/ Adhesive

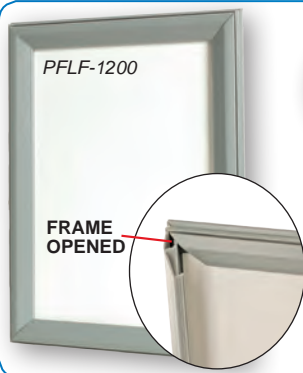
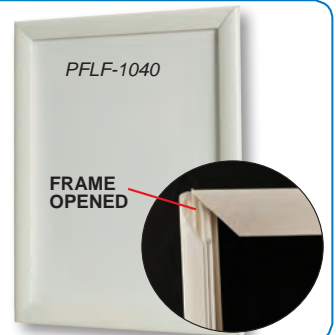

12 FT. LENGTHS
WHITE (*WH), BLACK (*BK), SILVER (*SL)

• Material: Dual Durometer PVC
 • Metal corner to hold miter cut

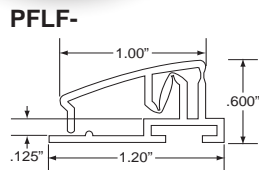
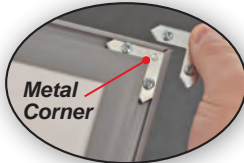

PART #	DESCRIPTION
PFLF-1200-*	w/o Adhesive
PFLF-1200A-*	w/ Adhesive

METAL CORNER	PART #
	PFLF-1200-CORN

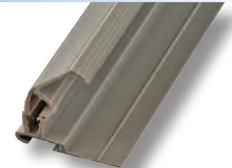

PLASTIC FRAME MOULDINGS

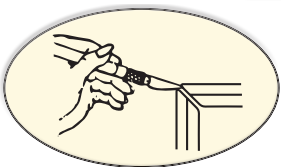

EZ FRAME

12 FT. LENGTHS
WHITE & BLACK
 UP TO 1/4" THICK MATERIAL

PART#
981EZ-WH
981EZ-BK

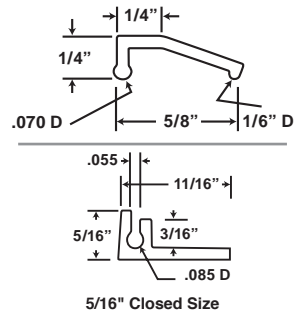

EZ Frame #981 comes in two pieces that are channeled with the back piece (981b) mounted flush to the wall with double face tape for ease of installation.

There is no need to take down frames from wall to change a new picture.

PLEASE NOTE: Our adhesive is strong but is only designed to assist in assembly. Remember always to staple or screw to substrate.

SIGN / BANNER HOLDERS



THE "SNAP-EASE" ALUMINUM BANNER HANGING SYSTEM

CLEAR ANODIZED ALUMINUM
• 24", 36", 48" & 96" LENGTHS



PRODUCT FEATURES:

- Clear anodized aluminum finish with 2 black plastic end caps for a "finished" look
- The spring clips inside the rail will "snap" close to securely hold your banner in place
- Ideal for paper, fabric and vinyl banners up to .08" thick
- Recommend to be used at the bottom of your banner for added stability
- Includes removable hanging clips. The banner hanging system can be attached to the wall or hung from the ceiling using our ceiling hooks shown on [page 156](#)



Single Lengths with 2 Hanging Clips and 2 End Caps

PART #	LENGTH
SNAP-ALU-24	24"
SNAP-ALU-36	36"
SNAP-ALU-48	48"

Top & Bottom Rail Sets with 2 Hanging Clips and 4 End Caps

PART #	LENGTH
SNAP-SET-24	24"
SNAP-SET-36	36"
SNAP-SET-48	48"

Customize Your Own Length With Our Single Length 8' Rail

PART #	LENGTH
SNAP-ALU-96	96"

Comes with 2 hanging clips, 2 end caps and 6 spring clips

Components To Complete Your Customization



PART #	DESCRIPTION
SNAP-HC	Hanging Clips
SNAP-EC	End Caps
SNAP-SC	Spring Clips

SNAP EASE SIGN KITS

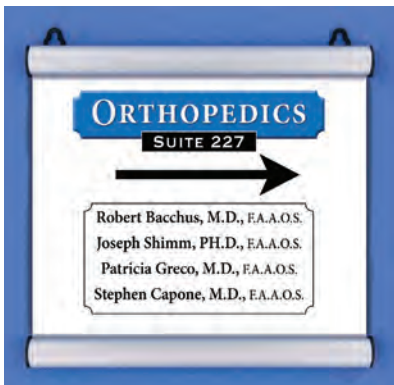

- Vertical or Horizontal mounting
- All inclusive kits - 2 lengths banner holders, 2 hanging clips, 4 end caps & 2 spring clips

PART #	LENGTH
SNAP-KIT-8	8-1/2"
SNAP-KIT-11	11"



MAKE YOUR OWN FLIP FRAME DISPLAY!

Perfect for "3 Dimensional" Samples

Incorporate a Flip Frame into any display or any space where you need it!
Ideal for displaying samples of Carpeting, Flooring, Tiles

MATERIAL: BLACK (Steel) FRAME

PRODUCT FEATURES:

- Powder coated steel
- Single panels
- Fits into a 1/4" hole
- Maximum thickness frame can accommodate 7/32"

Use our Foga® System (pgs. 189-201) or tubing (pgs. 202-209) to make your own display

Fabricate and simply insert your frame into your display

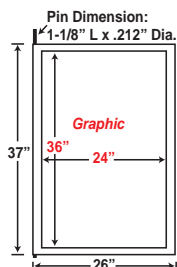

PART #	DESCRIPTION
FTF-FRAME	37" H x 26" x 11/32" Thick W Double Sided Flip Through Frame 36-3/16" H x 25-3/16" W Reveal
FTF-CLEAR	.01" Thick Clear Protective Cover for 37" H x 26" W Flip Through Frame
FTF-BACKER	.035" Thick White Backer Board for 37" H x 26" W Flip Through Frame

FLIP THROUGH FRAME DISPLAYS

MATERIAL: BLACK (Steel) FRAME w/CLEAR PROTECTIVE COVER & WHITE BACKER
• VARIOUS SIZES & STYLES

PRODUCT FEATURES:

- Fits 24"W x 36"H graphics & posters
- Make the most out of valuable retail or showroom space
- Perfect for art shops, tattoo studios, schools, museums & exhibits
- Freestanding units w/storage racks & wall mount units available



Shown: FTF-F20-BK

FREESTANDING DISPLAYS

PART #	NUMBER OF:			OVERALL SIZE
	DOUBLE SIDED FRAMES	DISPLAYED IMAGES	POSTERS RACK HOLDS	
FTF-F10-BK	10	20	120	27-1/2" D x 34" W x 79" H
FTF-F24-BK	24	48	336	27-1/2" D x 37" W x 79" H
FTF-F30-BK	30	60	480	27-1/2" D x 43-3/4" W x 79" H



Shown: FTF-W30-BK

WALL UNIT DISPLAYS

PART #	NUMBER OF:		OVERALL SIZE
	DOUBLE SIDED FRAMES	DISPLAYED IMAGES	
FTF-W10-BK	10	20	26" D x 29" W x 41" H
FTF-W20-BK	24	40	26" D x 34" W x 41" H
FTF-W30-BK	30	60	26" D x 39" W x 41" H

ALUMINUM FRAME PROFILES

SNAP-EASE FRONT LOADING FRAME PROFILES



OIL RUBBED BRONZE ANODIZED, CLEAR ANODIZED, BLACK POWDER COATED, MILL & BRUSHED NICKEL ANODIZED FINISH

New WOODGRAIN FINISHES AVAILABLE, PLEASE INQUIRE, MINIMUMS APPLY

• 8 FT. LENGTHS

PRODUCT FEATURES

- 5 profiles to choose from
- Stocked in 8' lengths & can be shipped via
- Each profile includes top & bottom
- Corners & spring clips are sold separately.

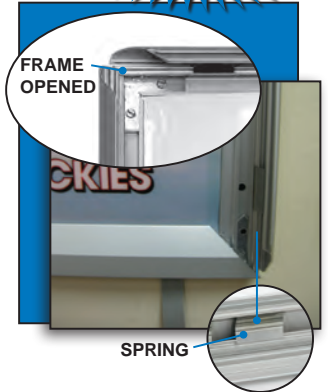

AVAILABLE FINISHES



NOTES:

4 Corners are needed for each frame assembly. Must use the designated corner for each profile as specified.
Must use 2 springs for each side. It is recommended to use one spring every 12"-16".

Most profiles can be supplied with a mill base & anodized/powder coated top - Please inquire.

PROFILES:

FLF-19P1-

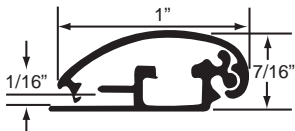

PART #	FINISH
FLF-19P1-M	Mill Finish
FLF-19P1-AL	Clear Anodized Finish
FLF-19P1-BK	Black Powder Coated Finish
FLF-19P1-BRN	Brushed Nickel Anodized Finish (Top)
FLF-19P1-ORB	Oil Rubbed Bronze Anodized Finish
PART # REQUIRED ACCESSORIES	
FLF-19P-CORNER	Corners (for joining mitered frame)
FLF-19P-SPRING	Springs (for FLF-19P1-)

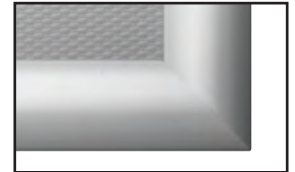

FLF-8-

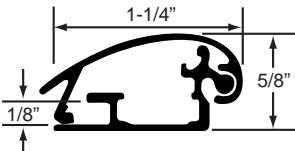

PART #	FINISH
FLF-8-M	Mill Finish
FLF-8-AL	Clear Anodized Finish
FLF-8-BK	Black Powder Coated Finish
FLF-8-BRN	Brushed Nickel Anodized Finish (Top)
FLF-8-ORB	Oil Rubbed Bronze Anodized Finish
PART # REQUIRED ACCESSORIES	
FLF-CORNER	Corners (for joining mitered frame)
FLF-SPRING	Springs (for FLF-8-)

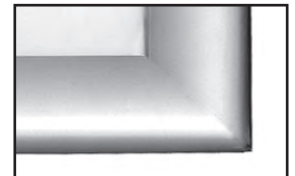

FLF-37S-

New

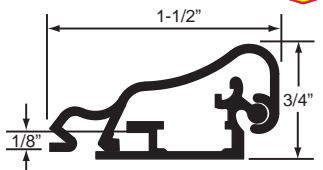

PART #	FINISH
FLF-37S-M	Mill Finish
FLF-37S-AL	Clear Anodized Finish
FLF-37S-BK	Black Powder Coated Finish
FLF-37S-BRN	Brushed Nickel Anodized Finish (Top)
FLF-37S-ORB	Oil Rubbed Bronze Anodized Finish
PART # REQUIRED ACCESSORIES	
FLF-37S-CORNER	Corners (for joining mitered frame)
FLF-37S-SPRING	Springs (for FLF-37S-)



FLF-19N-

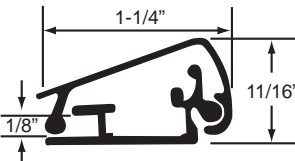

PART #	FINISH
FLF-19N-M	Mill Finish
FLF-19N-AL	Clear Anodized Finish
FLF-19N-BK	Black Powder Coated Finish
FLF-19N-BRN	Brushed Nickel Anodized Finish (Top)
FLF-19N-ORB	Oil Rubbed Bronze Anodized Finish
PART # REQUIRED ACCESSORIES	
FLF-19N-CORNER	Corners (for joining mitered frame)
FLF-19N-SPRING	Springs (for FLF-19P1-)



FLF-29S-

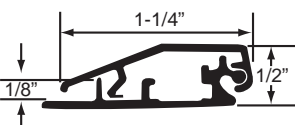

PART #	FINISH
FLF-29S-AL	Clear Anodized Finish
FLF-29S-BK	Black Powder Coated Finish
PART # REQUIRED ACCESSORIES	
FLF-29S-CORNER	Corners (for joining mitered frame)
FLF-29S-SPRING	Springs (for FLF-29S-)



FULLY ASSEMBLED FRAMES

DESIGNER "SNAP-EASE" FRONT LOADING FRAMES

New

ALUMINUM FRAME WITH HIGH QUALITY SATIN SILVER FINISH

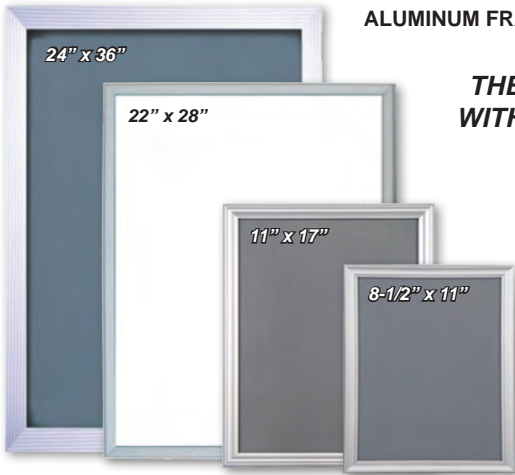

**THE LOOK OF ORNATE FRAMING
WITH EASY ACCESS TO GRAPHICS**

PRODUCT FEATURES:

- Fully assembled frame with back panel
- Screw holes on the back for easy mounting, vertically or horizontally
- Each frame includes a frosted protective cover to prevent glare
- Custom size and powder coat/anodized finishes are available at a minimum. Please inquire for more details

1/4" FRAME WITH MITERED CORNERS *Style A*

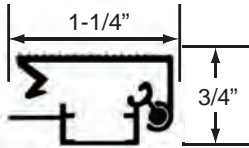

PART #	GRAPHIC SIZE	REVEAL DIMENSIONS	OVERALL DIMENSIONS
FRMD-A8511-SS	8-1/2" x 11"	7-13/16" x 10-5/16"	10" x 12-11/16"
FRMD-A1117-SS	11" x 17"	10-5/16" x 16-5/16"	12-1/2" x 18-11/16"
FRMD-A2228-SS	22" x 28"	21-5/16" x 27-5/16"	23-1/2" x 29-11/16"
FRMD-A2436-SS	24" x 36"	23-5/16" x 35-5/16"	25-1/2" x 37-11/16"



1-1/4" FRAME WITH MITERED CORNERS *Style B*

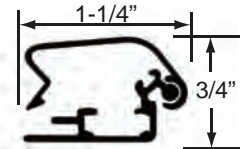

PART #	GRAPHIC SIZE	REVEAL DIMENSIONS	OVERALL DIMENSIONS
FRMD-B8511-SS	8-1/2" x 11"	8" x 10-1/2"	9-1/4" x 11-3/4"
FRMD-B1117-SS	11" x 17"	10-1/2" x 16-1/2"	10-3/4" x 17-3/4"
FRMD-B2228-SS	22" x 28"	21-1/2" x 27-1/2"	21-3/4" x 27-3/4"
FRMD-B2436-SS	24" x 36"	23-1/2" x 35-1/2"	23-3/4" x 35-3/4"

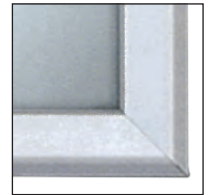

1-7/16" FRAME WITH MITERED CORNERS *Style C*

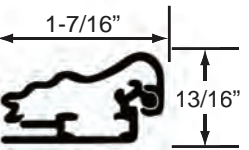

PART #	GRAPHIC SIZE	REVEAL DIMENSIONS	OVERALL DIMENSIONS
FRMD-C8511-SS	8-1/2" x 11"	8-1/4" x 10-3/4"	9-9/16" x 12-3/16"
FRMD-C1117-SS	11" x 17"	10-3/4" x 16-3/4"	12-3/16" x 18-3/16"
FRMD-C2228-SS	22" x 28"	21-3/4" x 27-3/4"	23-3/16" x 29-3/16"
FRMD-C2436-SS	24" x 36"	23-3/4" x 35-3/4"	25-3/16" x 27-3/16"



1-5/8" FRAME WITH MITERED CORNERS *Style D*

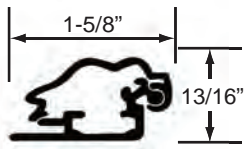

PART #	GRAPHIC SIZE	REVEAL DIMENSIONS	OVERALL DIMENSIONS
FRMD-D8511-SS	8-1/2" x 11"	8" x 10-1/2"	9-5/8" x 12-1/8"
FRMD-D1117-SS	11" x 17"	10-1/2" x 16-1/2"	12-1/8" x 18-1/8"
FRMD-D2228-SS	22" x 28"	21-1/2" x 27-1/2"	23-1/8" x 29-1/8"
FRMD-D2436-SS	24" x 36"	23-1/2" x 35-1/2"	25-1/8" x 37-1/8"



1-3/4" FRAME WITH MITERED CORNERS *Style E*

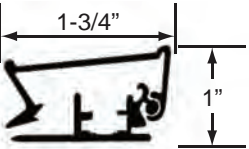

PART #	GRAPHIC SIZE	REVEAL DIMENSIONS	OVERALL DIMENSIONS
FRMD-E8511-SS	8-1/2" x 11"	7-5/8" x 10-1/8"	9-3/8" x 11-7/8"
FRMD-E1117-SS	11" x 17"	10-1/8" x 16-1/8"	11-7/8" x 17-7/8"
FRMD-E2228-SS	22" x 28"	21-1/8" x 27-1/8"	22-7/8" x 28-7/8"
FRMD-E2436-SS	24" x 36"	23-1/8" x 35-1/8"	24-7/8" x 36-7/8"



Custom sizes & finishes can be produced. Please Inquire.

Packed 5 per carton.

FULLY ASSEMBLED FRAMES

"SNAP-EASE" FRONT LOADING FRAMES

SILVER (Clear Anodized) or BLACK (Powder Coated) with Matte Finish
• VARIOUS SIZES & STYLES



Shown: FRM-N1117-SIL

PRODUCT FEATURES:

- Fully assembled frame with back panel
- Screw holes on the back for easy mounting, vertically or horizontally
- Each frame includes a frosted protective cover to prevent glare
- Stocked finishes indicated below. Custom powder coated options (red, blue & green) available at a minimum. Please inquire for more details.

5 Sizes To Choose From!



* Easel back option available for 8-1/2" x 11" and 11" x 17" only. Please add "-E" to end of part #

1" FRAME WITH MITERED CORNERS *Style A*

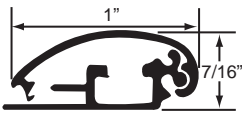

PART #	GRAPHIC SIZE	REVEAL DIMENSIONS	OVERALL DIMENSIONS	FINISH
FRM-8511-SIL*	8-1/2" x 11"	7-5/8" x 10-1/8"	9-11/16" x 12-3/16"	Silver (Clear Anodized)
FRM-8511-BK*	8-1/2" x 11"	7-5/8" x 10-1/8"	9-11/16" x 12-3/16"	Black (Powder Coated)
New FRM-1117-SIL*	11" x 17"	10-1/4" x 16-3/16"	12-1/4" x 18-3/16"	Silver (Clear Anodized)
New FRM-1117-BK*	11" x 17"	10-1/4" x 16-3/16"	12-1/4" x 18-3/16"	Black (Powder Coated)
FRM-1620-SIL	16" x 20"	15-1/8" x 19-1/8"	17-3/16" x 21-3/16"	Silver (Clear Anodized)

1-1/4" FRAME WITH MITERED CORNERS *Style B*

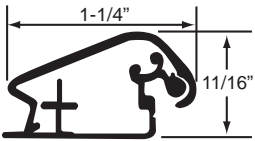

PART #	GRAPHIC SIZE	REVEAL DIMENSIONS	OVERALL DIMENSIONS	FINISH
FRM-2228-SIL	22" x 28"	21-5/8" x 27-11/16"	24-1/8" x 30-1/8"	Silver (Clear Anodized)
New FRM-2228-BK	22" x 28"	21-5/8" x 27-11/16"	24-1/8" x 30-1/8"	Black (Powder Coated)
FRM-2436-SIL	24" x 36"	23-1/2" x 35-5/8"	26-1/8" x 38-1/8"	Silver (Clear Anodized)
New FRM-2436-BK	24" x 36"	23-1/2" x 35-5/8"	26-1/8" x 38-1/8"	Black (Powder Coated)

1-1/4" FRAME WITH MITERED CORNERS *Style C*

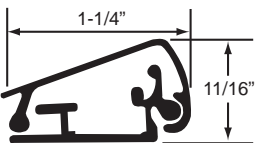

PART #	GRAPHIC SIZE	REVEAL DIMENSIONS	OVERALL DIMENSIONS	FINISH
FRM-N8511-SIL*	8-1/2" x 11"	8-1/16" x 10-5/8"	10-3/16" x 13-3/16"	Silver (Clear Anodized)
FRM-N1117-SIL*	11" x 17"	10-1/4" x 16-3/16"	12-3/16" x 18-1/8"	Silver (Clear Anodized)
FRM-N1620-SIL	16" x 20"	15-1/2" x 19-1/2"	18" x 22-1/8"	Silver (Clear Anodized)
FRM-N2228-SIL	22" x 28"	21-5/8" x 27-5/8"	24-1/8" x 30-1/8"	Silver (Clear Anodized)
FRM-N2436-SIL	24" x 36"	22-5/8" x 35-1/2"	26-1/4" x 38-1/16"	Silver (Clear Anodized)

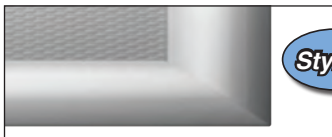

Style A



Style B



Style C

Custom sizes & finishes can be produced. Please Inquire.

Packed 5 per carton.

LED CRYSTAL LIGHT BOX

12 V

Sign

Material:
Clear Acrylic



Available From
8.5" x 11" to 24" x 36"
For Counter & Wall Mount



**Sleek
Thin
Design**

Plug & Play



Remove cover to place graphic

Cover
Your Graphic
Back Panel



WALL MOUNT

1" Depth



Comes with
4 standoffs,
1/2" Dia. x
1" Long

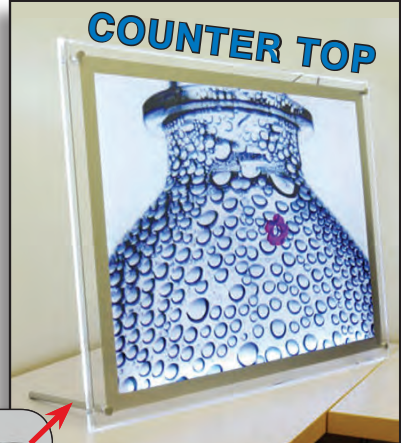

COUNTER TOP



Counter Top Leg

2"

- PRODUCT FEATURES:**
- Super thin under 3/8"
 - Available in wall mount & counter top
 - Power supply included



Constant Voltage power supply included.

PART #	COLOR TEMP	GRAPHIC SIZE	REVEAL DIMENSIONS	OVERALL DIMENSIONS	# OF LED CHIPS	TOTAL WATTAGE
CLB-LED-0811-W	Cool White	8.5" x 11"	8.26" x 10.83"	11.42" x 13.98"	24	24W
CLB-LED-1117-W		11" x 17"	10.83" x 16.73"	13.98" x 19.88"	42	42W
CLB-LED-1620-W		16" x 20"	15.79" x 19.8"	18.94" x 22.95"	54	54W
CLB-LED-2228-W		22" x 28"	20.5" x 26.5"	26.34" x 32.32"	60	60W
CLB-LED-2436-W		24" x 36"	22.5" x 34.5"	28.35" x 34.33"	66	66W
CLB-LED-0811-C		8.5" x 11"	8.26" x 10.83"	11.42" x 13.98"	24	24W
CLB-LED-1117-C	11" x 17"	10.83" x 16.73"	13.98" x 19.88"	42	42W	

Available for either wall mount (-w) or counter top (-c) applications.

LIGHTING SPECIFICATIONS			Constant Voltage	LUMINESCENCE COLOR LUMENS CLB-LED-0811-W 186 CLB-LED-1117-W 93 CLB-LED-1620-W 102 CLB-LED-2228-W 121 CLB-LED-2436-W 167 CLB-LED-0811-C 186 CLB-LED-1117-C 93	COLOR RENDERING INDEX CW=70	Average Rated For 50,000 Hours
COLOR TEMPERATURE						
Warm White	Pure White	Cool White	6100K			

LED LIGHTING

12 V

Sign

Material:

Aluminum Frame



ALUMINUM SNAP EASE FRONT LOADING FRAME LIGHT BOX



New



PRODUCT FEATURES:

- Easy front load feature
- Foam board backer included
- Comes ready to use: Mounting hardware, acrylic cover & power supply
- Plug & Play
- Pre-Assembled



Beveled Edge Profiles

COMES READY TO USE:
MOUNTING HARDWARE, ACRYLIC COVER & POWER SUPPLY INCLUDED!

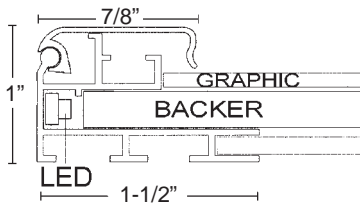

Pre-Assembled

Lighting Specification

Color Temperature		Cool White: 7500K-8500K
Warm White 1500K	Pure White 3000K	
Lumens		FLF-LED-0811: 275 FLF-LED-1117: 475 FLF-LED-1620: 625 FLF-LED-2228: 1000 FLF-LED-2436: 1250
Color Rendering Index		Cool White: 75-80
Average Rated For 50,000 Hours		



UL Power Supply Included!

PART #	COLOR TEMP	FINISH	GRAPHIC SIZE	REVEAL DIMENSIONS	OVERALL DIMENSIONS	# OF LED CHIPS	TOTAL WATTAGE
FLF-LED-0811	Cool White	Satin Silver	8.5" x 11"	8.08" x 10.64"	9.84" x 12.41"	36	3W
FLF-LED-1117	Cool White	Satin Silver	11" x 17"	10.64" x 16.55"	12.41" x 18.31"	48	4W
FLF-LED-1620	Cool White	Satin Silver	16" x 20"	15.59" x 19.61"	17.38" x 21.39"	66	6W
FLF-LED-2228	Cool White	Satin Silver	22" x 28"	21.58" x 27.61"	23.36" x 29.38"	120	10W
FLF-LED-2436	Cool White	Satin Silver	24" x 36"	23.78" x 37.48"	25.56" x 37.41"	156	13W

SPECIALTY LITERATURE POCKETS

New

MATERIAL: CLEAR PVC

- 4-1/2" W x 7" H x 3/4" D
- For tri-fold literature
- Nests for economical shipping
- Easy setup - "Flip up" front and snap together

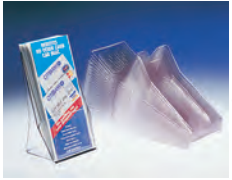

PART #
TFH-4



- For tri-fold brochures
- Good for outdoors
- Cover helps protect brochures

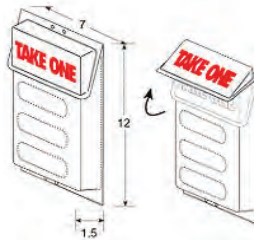

PART #
CBH-2

- Kit includes:
2 wood screws, 2 wire ties, 1 "Take one" sticker

- For 8-1/2" x 11" brochures
- Good for outdoors
- Cover helps protect brochures

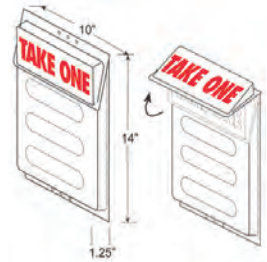

PART #
CBH-5

- Kit includes:
2 wood screws, 2 wire ties, 1 "Take one" sticker

For more Literature Holders, see pages 94-95.

STICK ON LITERATURE POCKETS

MATERIAL: CLEAR PVC

FLAT

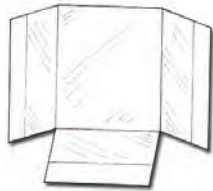

PART #

SIZE

FBH-31	3-1/2" W x 1-1/2" H x 3/4" D
FBH-45	4-1/16" W x 5" H x 1-1/4" D
FBH-87	8-5/8" W x 7" H x 1-1/4" D

PRE-FORMED



PART #

SIZE

PBH-31	3-1/2" W x 1-1/2" H x 3/4" D
PBH-45	4-1/16" W x 5" H x 1-1/4" D
PBH-87	8-5/8" W x 7" H x 1-1/4" D

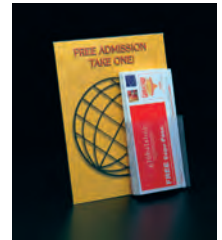

SHEET PROTECTORS

MATERIAL: CLEAR PVC
AVAILABLE IN MOST POPULAR SIZES



PART #

SIZE

VSP-46	4" W x 6" H
VSP-57	5" W x 7" H
VSP-810	8" W x 10" H
VSP-811	8-1/2" W x 11" H

STICK-IT

New

2-Sided Window And Wall Sign Holder
For Any Smooth Surface

.3mm Thick • Glossy Shatter-proof PVC
White Edges - Other Colors Available, Please Inquire

Removable! Reusable! Affordable! Convenient!

- Stick-it works best when applied to clear, dry & smooth surfaces
- Molecular gel needs no tools, holes, screws, wires, accessories to hold firmly
- Instantly protecting & displaying sign in any orientation, on glass from both sides
- Removable - holder/adhesive is reusable
- Adhesive is renewable - rinse off dirt with water & air dry
- Minimize direct sun exposure & temperature above 120°F / 50°C



*Perfect for Stores,
Offices, Hotels,
Restaurants, Hospitals,
Schools, Libraries, banks,
Homes, Cars, etc...*

PART #	COLOR	GRAPHIC SIZE	OVERALL SIZE
PMF-2WH	White	8-1/2" x 11"	8-1/2" x 13"

Like a "Post-it"...
Just Peel, Place and Press

*Leaves no residue
or mess behind
and lifts right off
to remove*



SELF STICK EASEL BACKS

QUICK, EASY AND EXTREMELY ECONOMICAL!

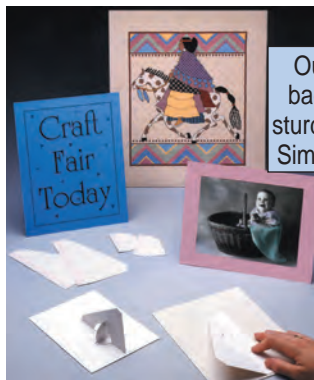

Our self stick easel backs are attractive, sturdy and easy to use. Simply Peel and Stick.

SINGLE WING



SINGLE WING

PART #	SIZE	COLOR
L328-1233B	3"	White
L328-1234B	5"	White
L328-1230B	7"	White
L328-1231B	9"	White
L328-1232B	12"	White
L328-1235B	15"	White
L328-3303B	3"	Black
L328-3305B	5"	Black
L328-3307B	7"	Black
L328-3309B	9"	Black
L328-3312B	12"	Black



DOUBLE WING

DOUBLE WING

PART #	SIZE	COLOR
L328-1236B	7"	White
L328-1237B	9"	White
L328-1238B	12"	White
L328-1239B	15"	White

UNIVERSAL COUNTER CARDS

FREE STANDING OR WALL MOUNTED

PRODUCT FEATURES:

- Clear plastic sleeve covers
- Heavy White Boards
- Durable construction
- Self standing easel back

Measurements are width x height; if you need height x width, please inquire.

REAR VIEW



FRONT VIEW



WALL MOUNT OPTION

NOTE: If you are wall mounting displays with pockets, you will need two rings in order for them to hang straight.

PART #	DESCRIPTION
UNI-HR	Hanging Rings w/Adhesive Tag

PART #	SIZE (W x H)
UNI-45	4" x 5"
UNI-57	5" x 7"
UNI-810	8" x 10"
UNI-8511	8.5" x 11"
UNI-912	9" x 12"
UNI-1014	10" x 14"
UNI-1114	11" x 14"
UNI-1117	11" x 17"
UNI-1215	12" x 15"
UNI-12175	12" x 17.5"
UNI-15175	15" x 17.5"
UNI-1620	16" x 20"
UNI-1722	17" x 22"
UNI-1824	18" x 24"

BROCHURE POCKETS

PEEL & STICK



DIMENSIONS

PART #	(W x H x Inside Dim.)
POC-1	Business Card Holder
POC-2	3.5" x 4.25" x 1.25"
POC-3	4" x 4.25" x 1.25"
POC-4	4.5" x 4.25" x 1.25"
POC-5	5.5" x 4.25" x 1.25"
POC-6	6.5" x 4.25" x 1.25"
POC-7	8.5" x 4.5" x 1.25"
POC-8	8.5" x 8" x 1.25"

CLEAR VINYL MAGNETIC POCKETS

OPEN SHORT SIDE CONFIGURATION (OS)

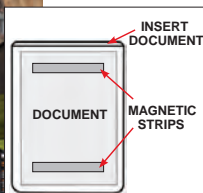

PRODUCT FEATURES:

- Clear scan through
- Document Holder/Card Holder comes with two magnetic strips on back, **(One strip for 4" x 6")**
- Has an open top sleeve with 1/4" drop-down opening on **short** or **long** side with beaded edges and round corners.
- Use on shelving racks, equipment, filing cabinets, etc.



OPEN LONG SIDE CONFIGURATION (OSL)

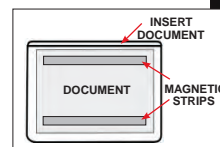

PART #	DIMENSIONS
CVP-312-OS*	4" x 6"
CVP-019-OS	5" x 6-3/4"
CVP-249-OS	5-1/2" x 8-7/8"
CVP-022-OS	6" x 9"
CVP-210-OS	9" x 12"

PART #	DIMENSIONS
CVP-1312-OSL*	6" x 4"
CVP-1019-OSL	6-3/4" x 5"
CVP-1249-OSL	8-7/8" x 5-1/2"
CVP-1022-OSL	9" x 6"
CVP-1210-OSL	12" x 9"

*-Comes with only one magnetic strip.

MERCHANDISING ESSENTIALS

CEILING GRID HOOKS, CLIPS & ACCESSORIES

Attract attention to your advertisement by using one of these hanging ceiling solutions

WORKS WITH STANDARD 1" CEILING GRID

GRID CLIPS / HOOKS

TWIST LOK CEILING CLIP

- Material: White Styrene
- Easy to remove and relocate
- Includes 6 ft. cord

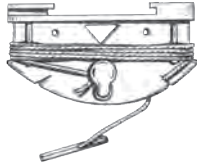

PART #
PTC-3

TWIST-A CEILING LOOPS

- Material: White Styrene
- Easy to remove and relocate
- Large loop accommodates a variety of hanging devices

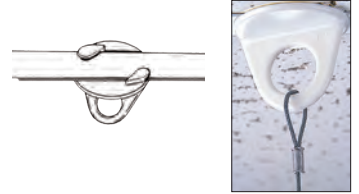

PART #
7100WH

SNAP ON CEILING GRID CLIP

- Material: Clear ABS
- 3/4" x 3/4" Clip with 3/16" Diameter hole
- Maximum 10 lb. weight capacity

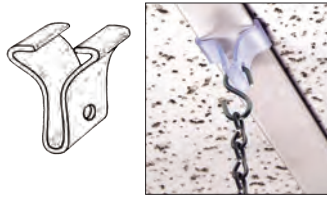

PART #
70-CG

SECURE METAL TWIST CEILING LOOP CLIP

- Material: White Painted Steel
- 1" W x 1-1/2" Long with 3/16" Diameter hole
- Fits most hooks



PART #
CH-7021

METAL SQUEEZE CLIP

- Material: Steel
- 1-5/8" W x 3-3/8" L
- Easy squeeze clip for quick installation



PART #
T250

STURDY GRILL CEILING HOOKS

- Material: Aluminum
- Hook measures 1-1/4" L x 1" W with 1/4" hook opening
- Use a right & left to create a strong hook
- Use 2 rights or 2 lefts to create a closed-end hook

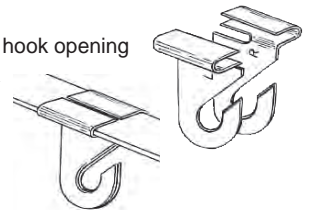

PART #
CH-1R
CH-1L

SNAP-EEZ™ HOOK HOLDER

- Material: White Styrene
- 1-1/4" x 7/8" Grid clip hook holder
- Works with slide hooks to hold graphics

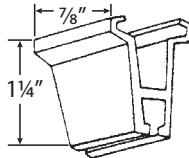

PART #
CH-1000

SNAP-EEZ™ SLIDE HOOKS

- Material: Crystal Clear Lexan™
- Available in 4.5" or 16" Long hooks
- Works with hook holder to hold and display graphics

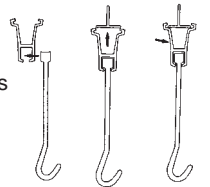

PART # **LENGTH**
CH-45 4.5" Long
CH-16 16" Long

UNIVERSAL HOOKS / CLIPS

UNIVERSAL PLASTIC CEILING HOOK

- Material: White Styrene
- Barbed on one side and designed to work with standard ceiling grid but also attaches to pipes, cables, hooks, etc.
- Includes 6" Long white cord



PART #
HWC-6

CEILING CLIP

- Material: White Styrene
- 3/4" x 3/4" Peel & Stick base with 3/16" Diameter loop
- Works with most hooks
- Can be used for vertical and horizontal applications



PART #
70-CL

CEILING HOOK

- Material: White Styrene
- 1" x 1" Peel & Stick base pad with J-Style hook
- Can be used for vertical and horizontal applications



PART #
70-HK

S-HOOKS

- Material: Bright Plated Steel
- These hooks not only work with the above ceiling applications, but with wire, shelving, hooks, etc.

PART # **SIZE**
T230 1" x .080 Dia.
T235 1-3/4" x .135 Dia.

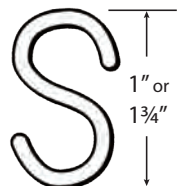

MERCHANDISING ESSENTIALS

SIGN HOLDERS / ROTO CLIPS

- SPRING TENSION CLIPS ARE EQUIPPED WITH SOCKET JOINT (S) THAT ROTATE AND TILT IN ALL DIRECTIONS
- MADE OF CLEAR POLYCARBONATE (Except where noted differently)

ROTO CLIPS UP TO 3/8" THICK MATERIAL

DOUBLE ROTO CLIP SIGN HOLDER

- Clips and holds material up to 3/8" thick
- Clip is 3/4" W x 1-1/2" H
- Overall clip is 3-3/4" L

PART #
RTC-10



ROTO CLIP SIGN HOLDER

- Clips and holds material up to 3/8" thick
- Clip is 2" W
- Overall clip is 2-7/8" L

PART #
RTC-20



ROTO CLIP EXTENDA SIGN HOLDER

- Clips and holds material up to 3/8" thick
- Clip is 1" W x 5/8" H
- Overall clip is 7-1/2" L

PART #
RTC-30



FLEXIBLE DOUBLE ROTO CLIP

- Clips and holds material up to 3/8" thick
- Clip is 3/4" W x 1-1/2" H
- Overall clip is 6" L

PART #
RTC-40



CLEVER CLIP

- Rotates and tilts 180° in any direction
- Holds material to 3/16" thick
- Easily attaches to wire fixtures up to 3/8" in diameter
- Overall clip is 1-1/2" L

PART #
GCLIP-CL



ROTO CLIPS UP TO 1" THICK MATERIAL

ROTO CLIP SENIOR SIGN HOLDER

- Sign holds material from .008" to .020" thick
- Clip measures 2" W x 7/8" H
- Overall clip is 4" L

PART #
RTC-50

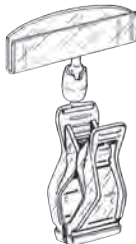

ROTO CLIP EXTENDA SENIOR SIGN HOLDER

- Sign holds material from .008" to .020" thick
- Sign holder measures 2" W x 7/8" H
- Overall clip is 6" L

PART #
RTC-60



ROTO CLIP EXTENDA PRINT PROTECTOR SIGN HOLDER **New**

- 5-1/2" W x 3-1/2" H crystal clear sign holder holds material up to 4" W x 2" H
- Overall clip is 8-1/2" L

PART #
RTC-38



ROTO CLIP JUMBO SIGN HOLDER

- Holds material up to 1/4" thick
- Sign holder measures 3-1/8" W x 4-1/4" H
- Overall clip is 4-1/4" L

PART #
RTC-70

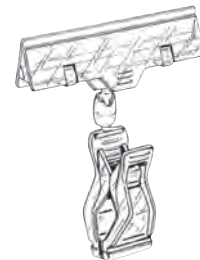

ROTO CLIP W/PRINT PROTECTOR SIGN HOLDER **New**

- Holds material 5-1/2" W x 3-1/2" H and up to 1/32" thick
- Overall clip is 6-1/2" L

PART #
RTC-35



ROTO CLIP MULTI-CHANNEL SIGNBOARD **New**

- Black plastic sign board holds one sign 4-1/16" H x 4" W or two signs 4" W x 2" H
- Overall clip is 6" L

PART #
RTC-39



ROTO CLIP EXTENDA JUMBO SIGN HOLDER

- Super strong 3-1/8" W sign holder holds material up to 1/4" thick
- Overall clip is 6-1/2" L

PART #
RTC-80

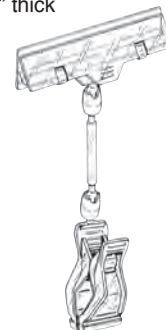

MERCHANDISING ESSENTIALS

SIGN HOLDERS / ROTO CLIPS

- SPRING TENSION CLIPS ARE EQUIPPED WITH SOCKET JOINT (S) THAT ROTATE AND TILT IN ALL DIRECTIONS
- MADE OF CLEAR POLYCARBONATE (Except where noted differently)

ROTO CLIP WITH SUCTION CUP

- Suction cup base with wobble extenda arm
- Clips and holds material up to 3/8" thick
- Clip is 3/4" W x 1-1/2" H
- Overall clip is 7" L

PART #
RTC-90



SURFACE MOUNT ROTO CLIPS

ROTO CLIP SIGN HOLDER WITH PEEL AND STICK BASE

New

- 3-1/2" Diameter peel and stick base w/rotate and tilt capability
- 3-1/2" W holds material up to 1/4" thick
- Overall clip is 7" L

PART #
RTC-75



ROTO CLIP SPIRAL WIRE WITH MAGNET

New

- Magnetic base with bendable white PVC wire clad completely bends and adheres to all steel surfaces
- Clip holds material up to 1/32" thick
- Overall clip is 12" L

PART #
RTC-26



ALUMINUM STRETCH FRAMES

New

SILVER (Clear Anodized) ALUMINUM POSTS with COORDINATING CORNER CONNECTORS



- Lightweight - ideally can hold up to 1/8" thick material
- Clean modern look
- Mounts vertically or horizontally
- Frame can be screw mounted to the wall (Use 2.5mm screws-not included) or adhere to glass or mirror with suction cups (included).

Mounting Options:

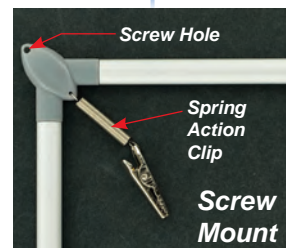

Unit Includes:



(4) 1/4" x 7/16"
Oval Posts



(4) Polystyrene Corners

(4) 1-1/4" Dia.
Suction Cups

Assembly:

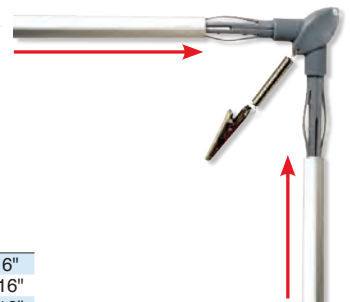

PART #	GRAPHIC SIZE	OVERALL SIZE
STFR-8511	8-1/2" x 11"	10-7/8" x 13-5/16"
STFR-1117	11" x 17"	13-5/16" x 19-5/16"
STFR-1620	16" x 20"	18-5/16" x 22-5/16"
STFR-2228	22" x 28"	24-5/16" x 30-3/16"
STFR-2436	24" x 36"	26-5/16" x 38-5/16"

**PORTABLE,
SETS UP IN SECONDS!**

PRODUCT FEATURES:

- Holds 8-1/2" x 11" literature and brochures
- Locking mechanism will securely keep unit in upright position while in use
- Canvas carry bag included

ZIG ZAG STYLE

MATERIAL = ALUMINUM & STEEL W/ACRYLIC SHELVES

Product Dimensions:

- Set up:** 11-1/8" W x 57-1/4" H x 10-3/4" D
Folded: 11-1/8" W x 4-1/2" H x 15-3/4" D
Shelves: 10" W x 12-7/8" H x 1" Lip
Shelf: 1/8" Thick
Base: 11-1/8" W x 15-3/4" D
Weight: 12 lbs.



**NUMBER OF
LITERATURE**

PART #	SHELVES	FINISH
FBH-1	5	Brushed Aluminum

VERTICAL STYLE

MATERIAL = STEEL W/ACRYLIC PRODUCTS

Product Dimensions:

- Set up:** 10-1/4" W x 62" H x 11" D
Folded: 10-1/4" W x 17-1/2" H x 11" D
Pockets: 9-1/2" W x 14" H x 1-1/2" D
Base: 10-1/2" W x 11" D
Weight: 12 lbs.



**NUMBER OF
LITERATURE**

PART #	SHELVES	FINISH
FBH-2	4	Matte Silver

TABLE STYLE

MATERIAL = STEEL & WOOD

Product Dimensions:

- Set up:** 19-7/8" W x 39-3/4" H x 14-3/4" D
Folded: 14-3/4" W x 7-5/8" H x 10-1/4" D
Pockets: 8-3/4" W x 14-3/4" H x 1-3/8" D
Table Top: 19-7/8" W x 14-3/4" H x 3/4" Thick
Base: 8-3/4" W x 10-1/4" D
Weight: 19 lbs.

**NUMBER OF
LITERATURE**

PART #	SHELVES	FINISH
FBH-3	3	Charcoal Grey Powder Coated w/Maple Laminate Table Top



New

FREE STANDING CLAMP IT GRAPHIC HOLDER

SINGLE & DOUBLE SIDE CLAMP STANDS

Material: Aluminum construction with powder coated steel base

Finishes: Satin Silver & Matte Black

Product Features:

- Overall height is 72"
- Aluminum pole comes in two 3' sections that screw together
- 1" Diameter aluminum pole
- Screw all components together, no additional hardware required!

PART #	DESCRIPTION
LRF-CMT1*	Single Sided Clamp It Stand
LRF-CMT2*	Double Sided Clamp It Stand

Extra Clamps Below



FLOOR TO CEILING CLAMP IT GRAPHIC HOLDER

FLOOR TO CEILING GRAPHIC HOLDER

Material: Aluminum construction with black plastic telescopic adjustment knob

Finishes: Satin Silver & Matte Black

Product Features:

- Maximize your floor space with this free standing portable pole!
- Adjustable up to 12' - can add a 4' or 8' extension for higher ceilings
- Aluminum upright: 1-3/8" diameter closes into a 1-1/2" diameter
- Screw all components together, no additional hardware required!

PART #	DESCRIPTION
LRF-CMT3*	Single Sided Clamp It Pole
LRF-CMT4*	Double Sided Clamp It Pole

4' or 8' extension pole available: Please Inquire

Extra Clamps Below

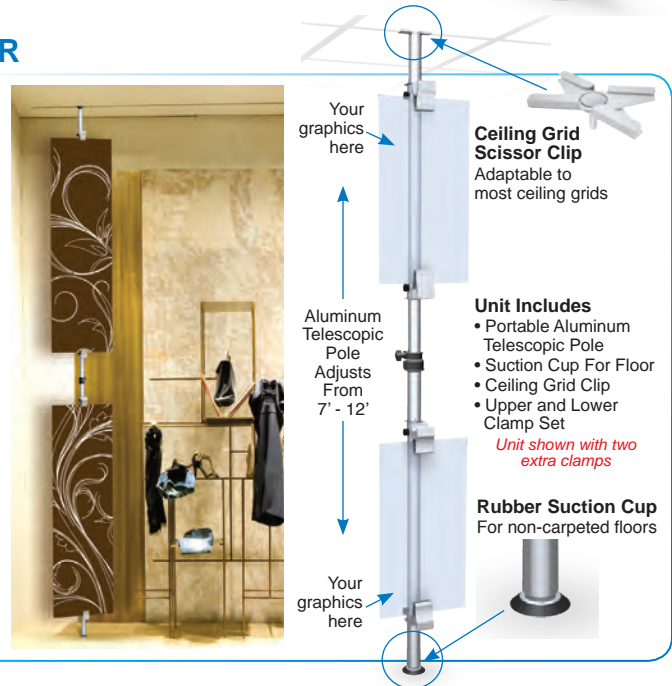

EXTRA CLAMPS

WORKS WITH FREE STANDING & FLOOR TO CEILING GRAPHIC HOLDERS

Single Sided Clamp
4.5" L x 2" W x 3" H

Double Sided Clamp
6" L x 2" W x 3" H



Product Features:

- Adjustment knob included on each clamp
- Finish: Satin Silver and Matte Black
- Clamps holds graphic up to 1/2" thick
- Ideal for lightweight self supporting graphics

Fits 1" Diameter Pole

PART #	DESCRIPTION
LRF-CLP1*	Single Sided Extra Clamps
LRF-CLP2*	Double Sided Extra Clamps

Fits 1-3/8" & 1-1/2" Diameter Pole

PART #	DESCRIPTION
LRF-CLP3*	Single Sided Extra Clamps
LRF-CLP4*	Double Sided Extra Clamps

CLAMP IT CLAMPS

CEILING MOUNT GRAPHIC HOLDER WITH POST

Material: Aluminum construction with steel ceiling grid clip
Finishes: Satin Silver & Matte Black

Product Features:

- Accepts one graphic, but viewable from both sides
- Clamps holds graphic up to 1/2" thick
- Ideal for lightweight self supporting graphics
- Easy assembly, no additional hardware required!

PART #	DESCRIPTION
LRF-CM5*	Ceiling Mount Clamp It w/Post

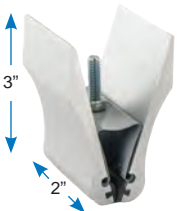

Clamp with male 1/4-20 thread, multifunctional



Ceiling Grid Clip
 Strong heavy duty scissors clip that is adaptable to most ceiling grids.

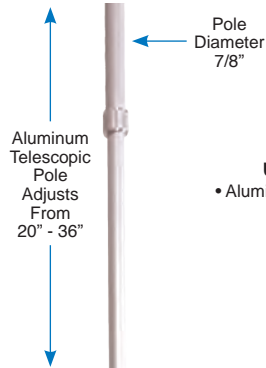

Unit Includes

- Aluminum Telescopic Pole
- Grid Clip
- One Clamp



CLAMP IT with EYE HOOK

Material: Aluminum clamp with rubber lined grip
Finishes: Satin Silver & Matte Black

Product Features:

- Accepts one graphic, but viewable from both sides
- Clamps holds graphic up to 1/2" thick
- Ideal for lightweight self supporting graphics
- Two clamps per 12" width is suggested

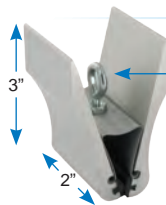

Clamp has integral eye hook for dropping graphics from the ceiling
 See below for stainless steel cable

PART #	DESCRIPTION
LRF-CMT6*	Clamp it with Eye Hook

Stainless Steel 3mm Cable with 2 Cable Sleeves

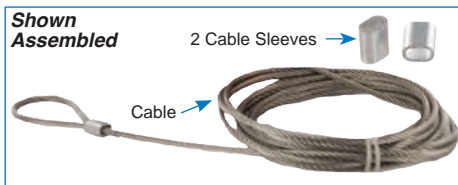

STAINLESS STEEL 3MM CABLE WITH 2 CABLE SLEEVES

PART #	DESCRIPTION
LRF-CLP6-1	1' Long Cable Assembly
LRF-CLP6-18	18" Long Cable Assembly
LRF-CLP6-2	2' Long Cable Assembly
LRF-CLP6-3	3' Long Cable Assembly
LRF-CLP6-4	4' Long Cable Assembly
LRF-CLP6-6	6' Long Cable Assembly

- Cable Finish: Brushed Stainless Steel
- Cable available from 1' to 6' long; for longer sizes, please inquire
- Proper anchoring of cable is required - Check building code requirements



SPECIALIZED CLAMP IT HOLDERS
IDEAL FOR LIGHTWEIGHT GRAPHICS

Material: Aluminum clamp with rubber lined grip
Finishes: Satin Silver & Matte Black

Product Features:

- Holds graphic up to 1/2" thick
- No assembly required!

WALL MOUNT CLAMP

Features hole for mounting parallel on a wall

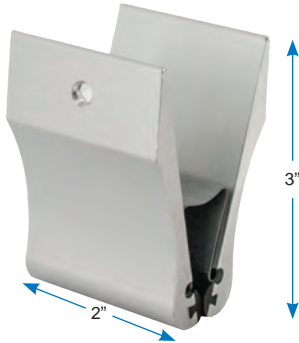

PART #	DESCRIPTION
LRF-CMT7-*	Wall Mount

TABLE TOP

Clamp only, use on table top, or for small signs

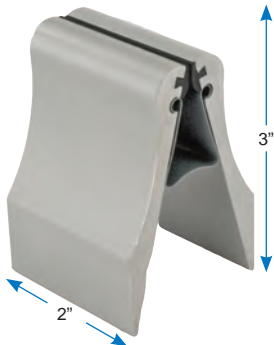

PART #	DESCRIPTION
LRF-CMT8-*	Table Top

SLATWALL MOUNT

Clamp with integral slatwall bracket included
 Fits all standard slatwall



PART #	DESCRIPTION
LRF-CMT9-*	Slatwall Mount

FRAMELESS STAND UP RIGID GRAPHIC HOLDERS

THE "L" FLOOR MOUNT STAND

Material: All steel powder coated base with felt base pads to protect floors

Finishes: Satin Silver & Matte Black

Product Features:

- Super strong heavy weight base - will not be knocked down easily!
- Available in widths ranging from 14" to 60"
- Single or double sided graphics for optimal viewing
- Graphic must support its own weight, but not exceed 6' in height
- No assembly required!

PART #	BASE	
	WIDTH	WEIGHT
LRF-FSU-L14-*	14"	12.75 lbs.
LRF-FSU-L24-*	24"	21.75 lbs.
LRF-FSU-L36-*	36"	32.50 lbs.
LRF-FSU-L48-*	48"	43.75 lbs.
LRF-FSU-L60-*	60"	54 lbs.

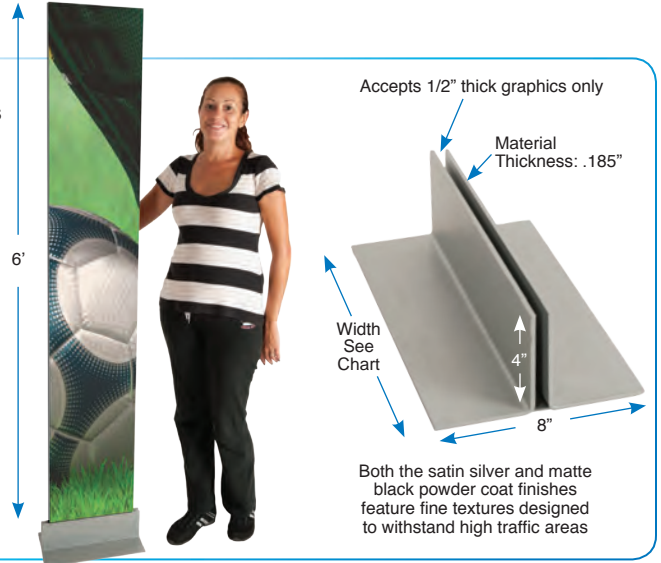

THE "M" FLOOR MOUNT STAND

Material: All steel powder coated base

Finishes: Satin Silver & Matte Black

Product Features:

- Available in widths ranging from 14" to 60"
- Single or double sided graphics for optimal viewing
- Graphic must support its own weight, but not exceed 6' in height
- Screw all components together, no additional hardware required!

PART #	BASE	
	WIDTH	WEIGHT
LRF-FSU-M14-*	14"	6 lbs.
LRF-FSU-M24-*	24"	10.50 lbs.
LRF-FSU-M36-*	36"	15.75 lbs.
LRF-FSU-M48-*	48"	21 lbs.
LRF-FSU-M60-*	60"	26 lbs.

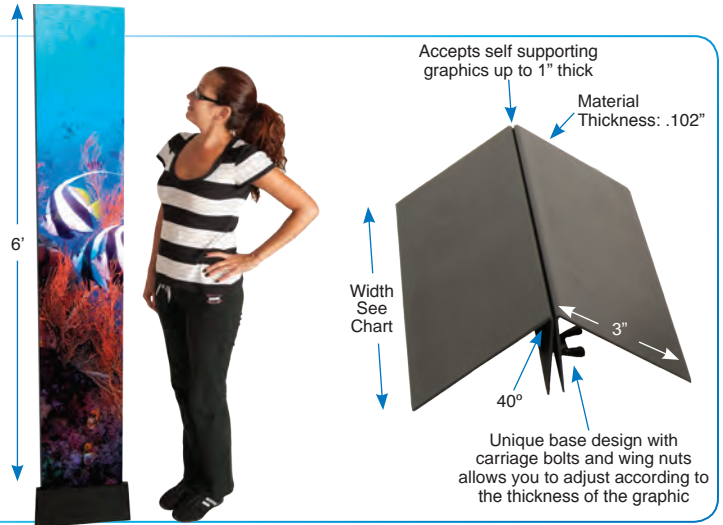

THE "C" FLOOR MOUNT STAND

Material: Lightweight aluminum base

Finishes: Satin Silver & Matte Black

Product Features:

- Adjustable, modern and stylish!
- Available in widths ranging from 7" to 48", but able to support wider width graphics
- Holds single or double sided graphics for optimal viewing
- Graphic must support its own weight, but not exceed 6' in height
- Tool free mounting, no additional hardware required!

PART #	BASE	
	WIDTH	WEIGHT
LRF-FSU-C07-*	7"	3.50 lbs.
LRF-FSU-C14-*	14"	6 lbs.
LRF-FSU-C24-*	24"	10 lbs.
LRF-FSU-C36-*	36"	15 lbs.
LRF-FSU-C48-*	48"	20 lbs.



New

COMPACT A-FRAME SIGN HOLDER

Material: Aluminum and steel construction
Finishes: Satin Silver & Matte Black

Product Features:

- Suitable for outdoors
- Dimensions Folded: 2-1/2" x 2-1/2" x 44-1/2"
- Overall height opened is 43"
- Overall weight is 5.5 lbs
- Accepts two graphics 22" x 28" or 24" x 36"
- Holds graphic up to 1/4" thick
- No assembly required



FOLDS EASILY FOR STORAGE & SHIPPING

Hinged to fold open and close

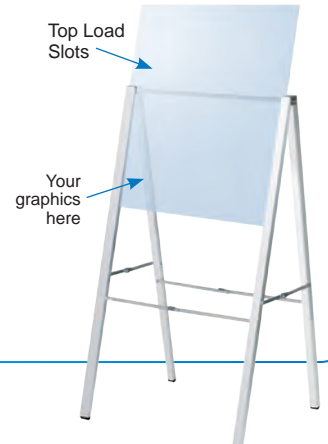

Top Load Slots

Your graphics here

Non-skid rubberized tips for the floor

PART #	GRAPHIC SIZE
LRF-CAF-22-*	22" x 28"
LRF-CAF-24-*	24" x 36"

CLASSIC BANNER STAND

Material: Aluminum construction with powder coated steel base
Finishes: Satin Silver & Matte Black

Product Features:

- Lightweight & Sturdy
- Overall height is 96"
- Overall weight is 9 lbs.
- Aluminum telescopic pole opens at 96" and closes at 36"
- 1/2" Diameter aluminum pole
- Recommended graphic size is 24" Wide x 8' High
- Accepts one or two vinyl graphics
- Hem your graphics to fit 1/2" diameter dowels
- Some assembly required - instructions enclosed with unit

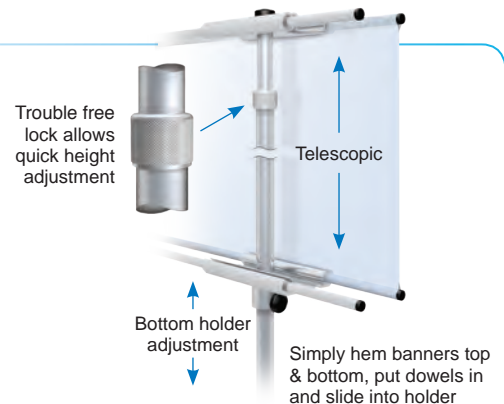

Trouble free lock allows quick height adjustment

Telescopic

Bottom holder adjustment

Simply hem banners top & bottom, put dowels in and slide into holder

- Unit Includes**
- 2 Hem Bars
 - Telescopic Pole
 - Square Floor Base

12" Square. Heavy duty steel with inner support bushing & backed on powder coated finish

PART #
LRF-CBS-*

ALUMINUM EASELS

5' 6" ECONOMY

Material: Lightweight aluminum construction- only 2.5 lbs.
Finishes: Satin Silver

Product Features:

- Lightweight and portable, supports loads up to 15 lbs.
- Overall height is 66"
- Overall weight is 2.5 lbs.
- Telescopic opens to 5' 6" height
- Aluminum pole: 5/8" diameter closes into 3/4" diameter
- Accepts rigid graphics
- No assembly required, simply take out of the box and use!

PART #
LRF-AEE-ALU

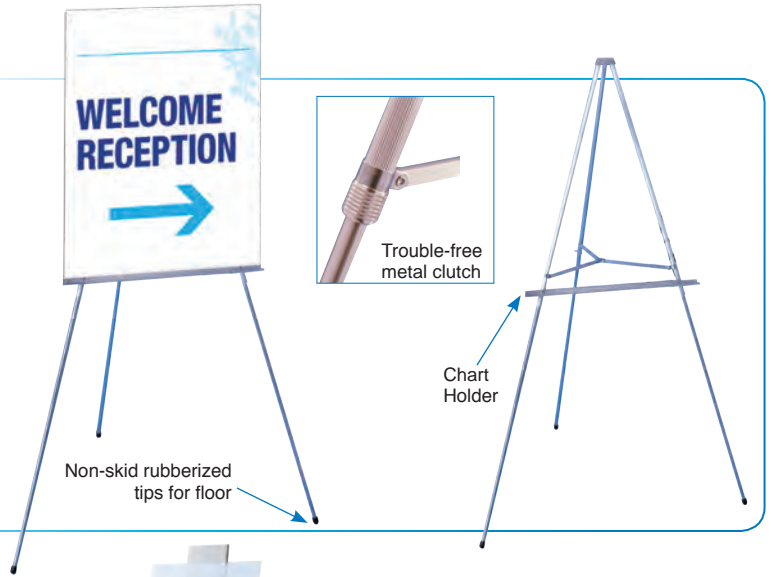

5' HEIGHT

Material: Lightweight aluminum alloy construction- only 4.5 lbs.
Finishes: Natural Aluminum & Matte Black

Product Features:

- Lightweight and portable, supports loads up to 50 lbs.
- 5' High
- Overall weight is 4.5 lbs.
- 3/4" x 1" Fluted rectangular poles
- Accepts rigid graphics
- No assembly required, simply take out of the box and use!

PART #
LRF-AE5-*

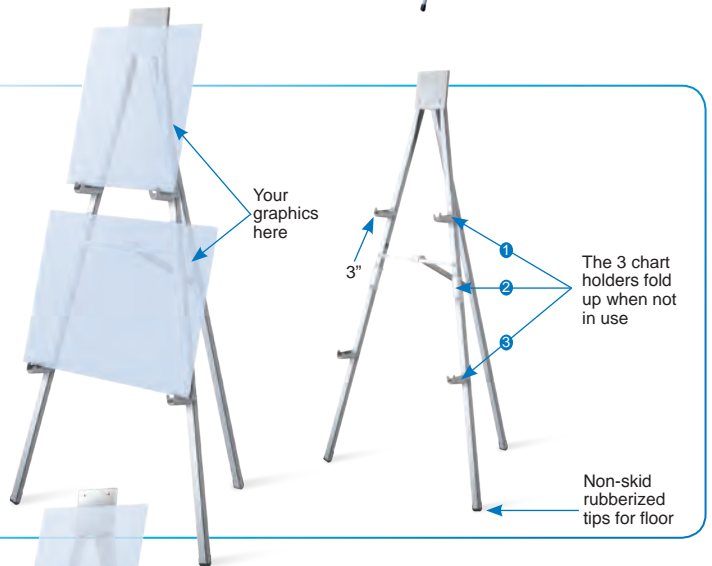

6' HEIGHT

Material: Lightweight aluminum alloy construction- only 5 lbs.
Finishes: Natural Aluminum & Matte Black

Product Features:

- Lightweight and portable, supports loads up to 50 lbs.
- 6' High
- Overall weight is 5 lbs.
- 3/4" x 1" Fluted rectangular pole
- Accepts rigid graphics
- No assembly required, simply take out of the box and use!

PART #
LRF-AE6-*

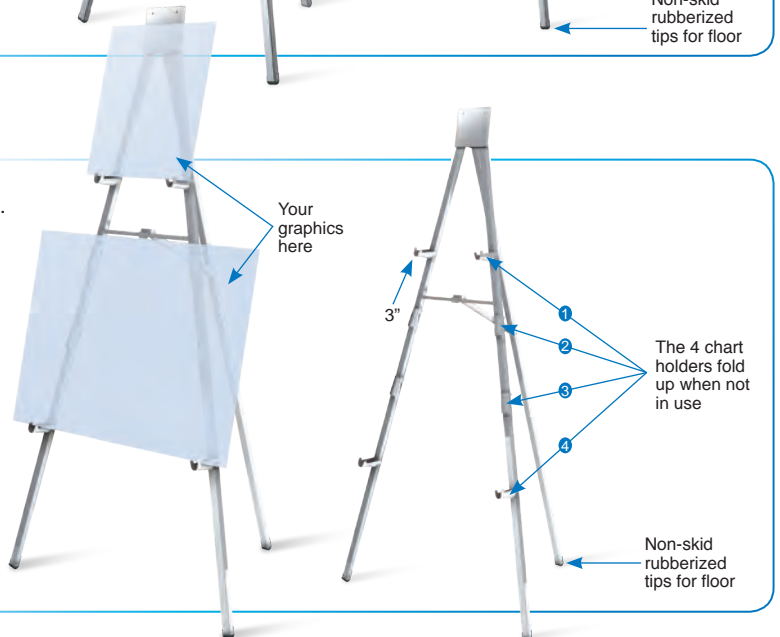

STAND UP GRAPHIC HOLDERS

GRANDE FREE STANDING GRAPHIC HOLDERS



WITH DOUBLE LEG

Material: Aluminum construction with powder coated steel base
Finishes: Satin Silver & Matte Black

Product Features:

- Overall size is 60" high x 29-1/4" wide
- Overall weight is 13 lbs.
- Pole height is 30"
- 1" round diameter aluminum pole
- Accepts up to 1/4" thick graphic including lens
- Screw all components together, no additional hardware required!

PART #	GRAPHIC SIZE	REVEAL DIMENSIONS
LRF-PST1-*	22" x 28"	20-3/4" x 26-3/4"

Lens sold separately, see page 167



Easy top loading!
Change graphics quickly and easily

- Unit Includes**
- Frame
 - Poles
 - Steel Base

12" x 14" rectangular steel base, 3/16" thick

WITH STYLISH RADIUS CORNERS

Material: Aluminum construction with powder coated steel base
Finishes: Satin Silver & Matte Black

Product Features:

- Stylish metal yoke ensures structural integrity
- Overall size is 65" high x 28-1/2" or 36-1/2" wide
- Upright height is 37"
- 1" x 2" Oval aluminum upright
- Accepts up to 1/4" thick graphic including lens
- Screw all components together, no additional hardware required!

PART #	GRAPHIC SIZE	REVEAL DIMENSIONS	OVERALL WEIGHT
LRF-PST2-*	22" x 28"	20-3/4" x 26-3/4"	12 lbs.
LRF-PST2A-*	24" x 36"	22-3/4" x 34-3/4"	13 lbs.

Lens sold separately, see page 167



Easy top loading!
Change graphics quickly and easily



Radius corners are aesthetically beautiful



Metal yoke insures structural integrity

- Unit Includes**
- Frame
 - Poles
 - Steel Base

17" diameter laser cut round steel base, 3/16" thick



ALUMINUM SIGN HOLDER

Material: Aluminum construction with electrically welded aluminum base

Finishes: Satin Silver & Matte Black

Product Features:

- Base can be weighted for extra stability!
- Overall size is 63" high x 29-1/4" wide
- Overall weight is 11 lbs.
- Pole height is 55-3/4"
- Floor to the bottom of the frame: 23-3/4"
- 3/4" x 1-1/2" Rectangular aluminum extension
- 20" x 33" Electrically welded aluminum base
- Screw all components together, no additional hardware required!

PART #	GRAPHIC SIZE	REVEAL DIMENSIONS
LRF-PST3-*	22" x 28"	20-3/4" x 26-3/4"

Lens sold separately, see below for pricing



Optional weighted cover
Sold separately
See below for pricing



Easy top loading!
Change graphics
quickly and easily

20" x 33" electrically
welded aluminum base

Unit Includes

- Frame
- Poles
- Aluminum Base

Your graphics here

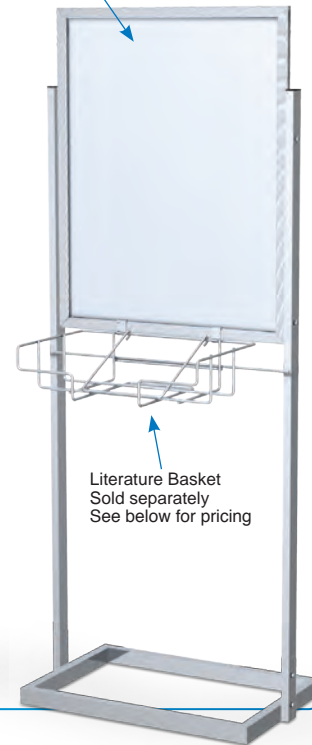

Literature Basket
Sold separately
See below for pricing

ACCESSORIES

Literature Basket

Fits 11" x 17" tabloids
or 8.5" x 11" stacks



LRF-BSK1-SIL

Works With: LRF-PST1 & LRF-PST2
Finish: Satin Silver

LRF-BSK2-SIL

Works With: LRF-PST3
Finish: Satin Silver

Weighted Base Cover

28 lb. cover which
sits atop base



LRF-PST3-BASE-*

Works With: LRF-PST3
Finishes: Satin Silver *(SIL) or Matte Black *(BK)

Clear Lenses

Sold in pairs



LRF-LENSE

22" x 28" Clear Lens Set .020" Thick
Works With: LRF-PST1, LRF-PST2 & LRF-PST3

LRF-LENSE-2

24" x 36" Clear Lens Set .020" Thick
Works With: LRF-PST2A

PETITE FREE STANDING GRAPHIC HOLDERS

Material: Aluminum construction with powder coated steel base
Finishes: Satin Silver & Matte Black

Product Features:

- Beautifully mitered, curvilinear design!
- Aluminum pole: 7/8" diameter closes into a 1" diameter
- Base Weight: 5 lbs
- Available for portrait or landscape
- Screw all components together, no additional hardware required!

PART #	GRAPHIC SIZE	REVEAL DIMENSIONS	ORIENTATION
LRF-BAN1-*	8-1/2" x 11"	7-3/4" x 10-1/4"	Portrait (-P-) Landscape (-L-)
LRF-BAN2-*	11" x 14"	10-1/4" x 13-1/4"	
LRF-BAN3-*	11" x 17"	10-1/4" x 16-1/4"	



- Unit Includes**
- Frame
 - Telescopic Pole
 - Steel Base

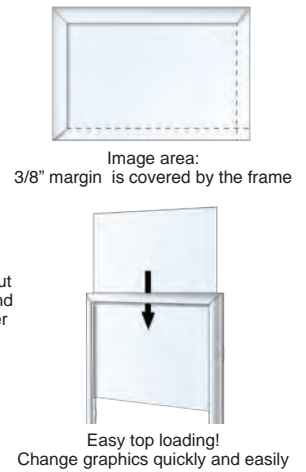
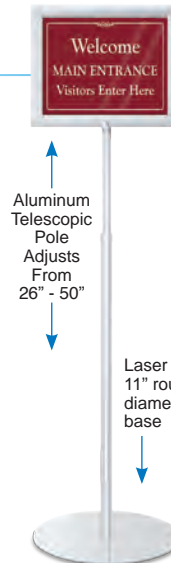

CURVED FREE STANDING GRAPHIC HOLDERS SINGLE

Material: Top/bottom portion of frame is plastic, frame sides are aluminum and base is powder coated steel
Finishes: Satin Silver & Matte Black

Product Features:

- Overall size is 66" high x 29-1/4" wide
- Overall weight is 19 lbs.
- Pole height is 36"
- 1" x 2" Oval Aluminum pole
- Recommended Graphic: Styrene or semi-rigid material, no less than .040" thick; recommended .060" thick
- Front loading! - Quickly change graphics without disassembling the unit
- Holds graphics ranging from .040" to .090" thick
- Screw all components together, no additional hardware required!

PART #	GRAPHIC SIZE	REVEAL DIMENSIONS
LRF-PST4-*	22" x 28"	21-1/4" x 28"



Laser cut 17" round diameter steel base

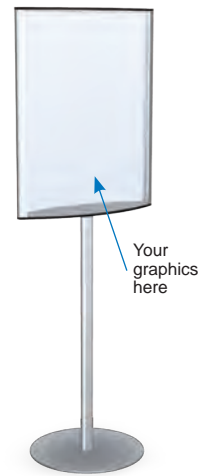

DOUBLE

Material: Top/bottom portion of frame is plastic, frame sides are aluminum and base is powder coated steel
Finishes: Satin Silver & Matte Black

Product Features:

- Overall size is 58" high x 29-1/4" wide
- Overall weight is 18 lbs.
- Accepts one to four single side graphics each 22" x 28"
- Recommended Graphic: Styrene or semi-rigid material, no less than .040" thick; recommended .060" thick
- Front loading! - Quickly change graphics without disassembling the unit
- Holds graphics ranging from .040 to .090 thick
- 5 minute assembly required, instructions enclosed with unit

PART #	GRAPHIC SIZE	REVEAL DIMENSIONS
LRF-PST5-*	22" x 28"	21-1/4" x 28"



THE SLIDE

Material: Aluminum construction

Finishes: Satin Silver and Matte Black

Product Features:

- Beautifully mitered, curvilinear design!
- Available for portrait and landscape designs
- Accepts up to 3/16" thick of graphic material including lens
- No assembly required

Unit Includes

- Frame
- 2 Clear Plastic Hanging Clips
- 2 Top & Bottom Wall Hangers



Side loading!
Change graphics
quickly and easily



Curvilinear Satin Silver

PART #	GRAPHIC SIZE	REVEAL DIMENSIONS	ORIENTATION
LRC-SLD-1117*	11" x 17"	10-1/4" x 16-1/4"	Portrait (-P-) Landscape (-L-)
LRC-SLD-2228*	22" x 28"	21-1/4" x 27-1/4"	
LRC-SLD-2436*	24" x 36"	23-1/4" x 35-1/4"	

Order Example: LRC-SLD-1117-P-SIL

Stainless Steel 3mm Cable with 2 Cable Sleeves

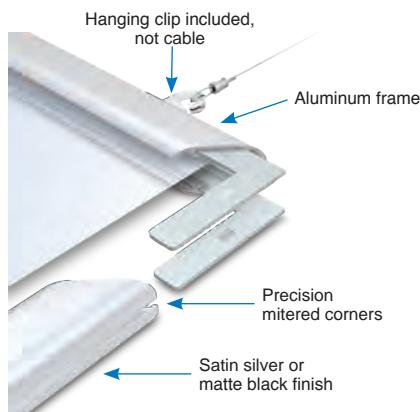
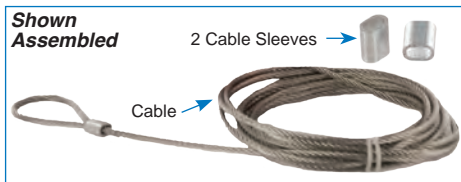

STAINLESS STEEL 3mm CABLE WITH 2 CABLE SLEEVES

PART #	DESCRIPTION
LRF-CLP6-1	1' Long Cable Assembly
LRF-CLP6-18	18" Long Cable Assembly
LRF-CLP6-2	2' Long Cable Assembly
LRF-CLP6-3	3' Long Cable Assembly
LRF-CLP6-4	4' Long Cable Assembly
LRF-CLP6-6	6' Long Cable Assembly

ACCESSORIES FOR THE SLIDE



Clear Lenses
Set of 2

PART #	SIZE
LRC-SLD-LENSE11	11" x 17"
LRC-SLD-LENSE22	22" x 28"
LRC-SLD-LENSE24	24" x 36"



Vertical Joiner
Set of 2 join bottom & crossbars vertically
LRC-SGA-VJ

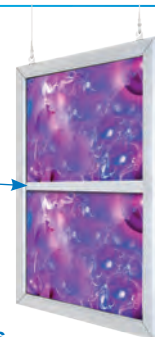

Dividers
12' Length
LRC-DIV12*
Finish: Satin Silver *(SIL) or Matte Black *(BK)

SNAP GRAPHIC GRIPPERS™ (PATENTED)

Material: Aluminum crossbar with co-extruded PVC gripper

Finishes: Satin Silver & Matte Black

Product Features:

- Quality gripper securely holds graphic after inserted into holder!
- Accepts single or double sided graphics
- Simply open plastic gripper, place graphic and snap close & load into aluminum casing
- Holds graphic up to .070 thick
- A variety of mounting options available for wall slatwall and ceiling *(See Below)*
- No assembly required, simply take out of the box and use!

PART #	LENGTH
LRC-SGG-22-*	22"
LRC-SGG-24-*	24"
LRC-SGG-28-*	28"
LRC-SGG-36-*	36"
LRC-SGG-48-*	48"
LRC-SGG-60-*	60"
LRC-SGG-72-*	72"

Unit Includes

- Top & Bottom Aluminum Casing
- Top & Bottom Plastic Grippers
- 2 Clear Plastic Hanging Clips
- 4 Black Plastic End Caps

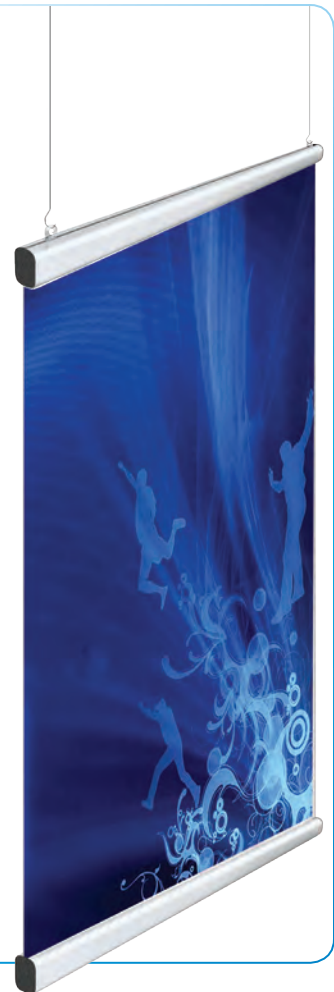

Stainless Steel 3mm Cable with 2 Cable Sleeves

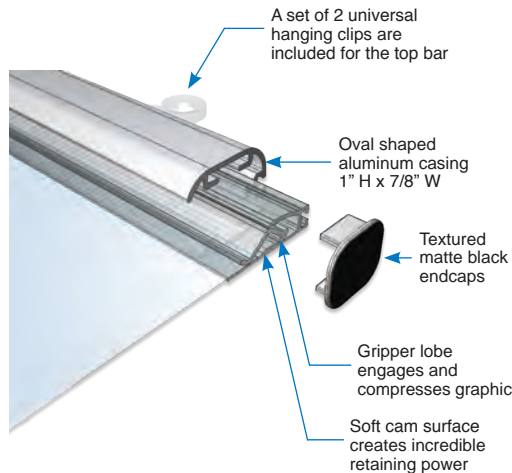
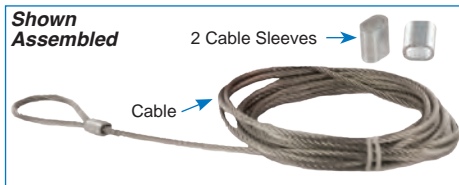

STAINLESS STEEL 3mm CABLE WITH 2 CABLE SLEEVES

PART #	DESCRIPTION
LRP-CLP6-1	1' Long Cable Assembly
LRP-CLP6-18	18" Long Cable Assembly
LRP-CLP6-2	2' Long Cable Assembly
LRP-CLP6-3	3' Long Cable Assembly
LRP-CLP6-4	4' Long Cable Assembly
LRP-CLP6-6	6' Long Cable Assembly

ACCESSORIES FOR SNAP GRAPHIC GRIPPERS™



Wall Mount Kit

Set of 4 brackets for top & bottom cross bar
LRC-SGA-WMK



Slatwall Bracket Kit

Set of 2 for top bar & maximum length of 36"
LRC-SGA-SWB-SIL
Finish: Satin Silver



Perpendicular Wall Mount Bracket

Set of 2 for top bar & maximum length of 36"
LRC-SGA-WMB-
Finish: Satin Silver **(SIL)* or Matte Black **(BK)*



Horizontal Joiner

Set of 4 join top & crossbars horizontally
Allows casings to be joined in series
LRC-SGA-HJ

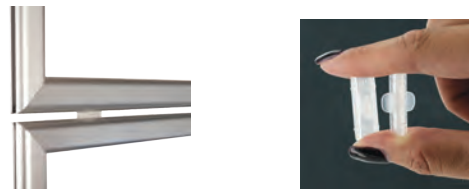

Vertical Joiner

Set of 2 join bottom & crossbars vertically
LRC-SGA-VJ

HEM GRAPHIC BAR

Material: Lightweight aluminum bars

Finishes: Satin Silver

Product Features:

- Simply hem your graphics for top and bottom tubes
- Accommodates banner widths from 18" to 240"
- Ideal for vinyl banners
- Hem your graphics to fit a 7/8" or 1-1/4" diameter tube
- Hem bar is sold with eye bolt at the top crossbar and can be hung with cable and hooks
- For banner widths up to 72" long: No assembly required-ships in one section
- For banner widths greater than 72": Crossbar ships in 2 to 4 sections

- Unit Includes**
- Top & Bottom Crossbars
 - Eye Bolts For Each Top Crossbar
 - Black Plastic End Caps



PART #	BANNER WIDTH	DIAMETER	SECTIONS
LRC-HGB-*18-SIL	18"	7/8"	1
LRC-HGB-*22-SIL	22"	7/8"	1
LRC-HGB-*24-SIL	24"	7/8"	1
LRC-HGB-*28-SIL	28"	7/8"	1
LRC-HGB-*36-SIL	36"	7/8"	1
LRC-HGB-*48-SIL	48"	7/8"	1
LRC-HGB-*60-SIL	60"	7/8"	1
LRC-HGB-*72-SIL	72"	7/8"	1
LRC-HGB-*96-SIL	96"	1-1/4"	2
LRC-HGB-*120-SIL	120"	1-1/4"	2
LRC-HGB-*144-SIL	144"	1-1/4"	2
LRC-HGB-*180-SIL	180"	1-1/4"	3
LRC-HGB-*240-SIL	240"	1-1/4"	4

***Eye bolts can be placed at ends- Please Inquire**

Stainless Steel 3mm Cable with 2 Cable Sleeves

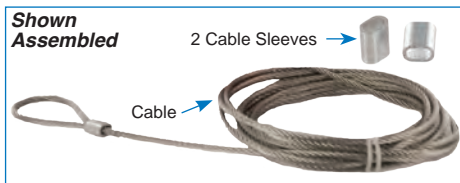

STAINLESS STEEL 3mm CABLE WITH 2 CABLE SLEEVES

PART #	DESCRIPTION
LRF-CLP6-1	1' Long Cable Assembly
LRF-CLP6-18	18" Long Cable Assembly
LRF-CLP6-2	2' Long Cable Assembly
LRF-CLP6-3	3' Long Cable Assembly
LRF-CLP6-4	4' Long Cable Assembly
LRF-CLP6-6	6' Long Cable Assembly

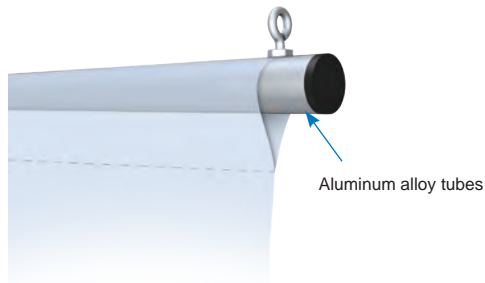
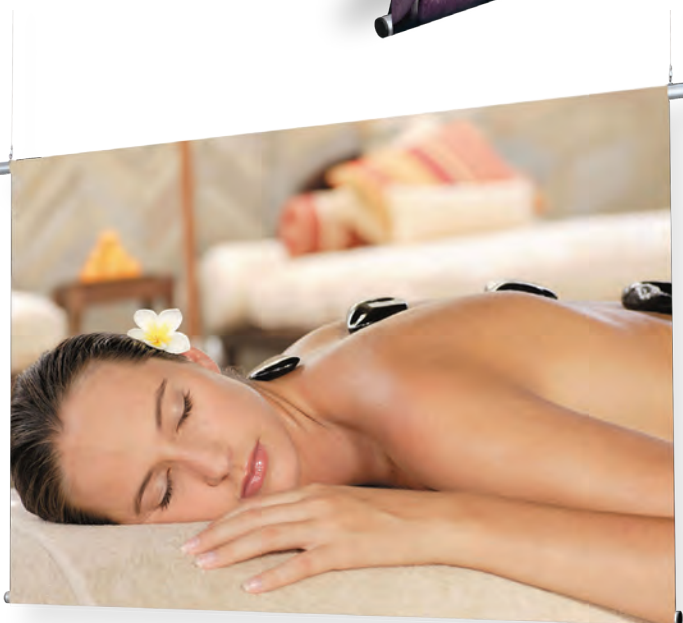

Aluminum alloy tubes

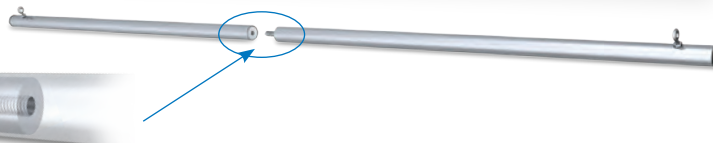

Multiple section units connect with solid aluminum turned bushing

PICTURE FRAME MOULDINGS

New

9 Ft. Lengths • Polystyrene • 100% Usable Material
Beautifully Finished!



Shown:
PM-920-70

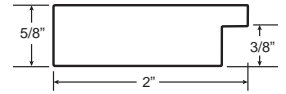

PART # FINISH
PM-7456 Black - Gold

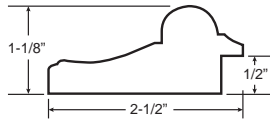

PART # FINISH
PM-0906 Antique Gold

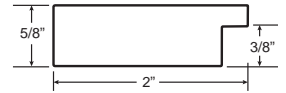

PART # FINISH
PM-7488 Espresso



PART # FINISH
PM-0907 Gold

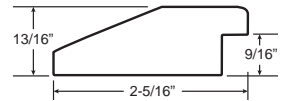
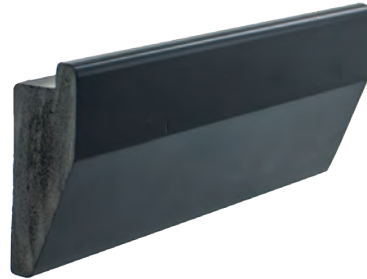

PART # FINISH
PM-920-70 Black

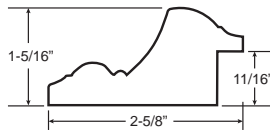

PART # FINISH
PM-1601 Rustic Gold

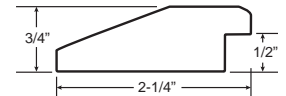

PART # FINISH
PM-920-88 Espresso

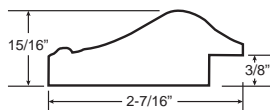

PART # FINISH
PM-554-02 Rustic Gold

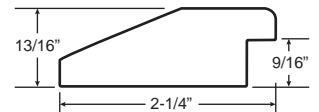

PART # FINISH
PM-920-89 Bronze

DECORATIVE PICTURE & MIRROR MOULDINGS

9 Ft. Lengths • Polystyrene • 100% Usable Material
Beautifully Finished!

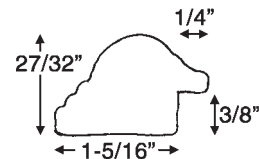

PART # FINISH
G PM-1243 Cherry w/Gold

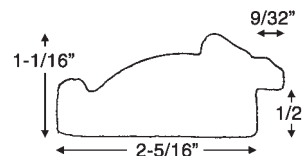

PART # FINISH
H PM-9811 Antique Bronze
I PM-9805 Antique Gold

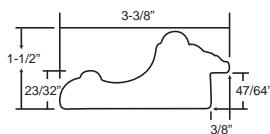

PART # FINISH
A PM-537-03 Pewter
B PM-537-04 Gold

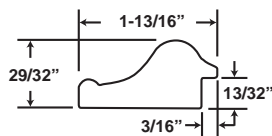

PART # FINISH
C PM-213-05 Gold
D PM-213-70 Gold/Black

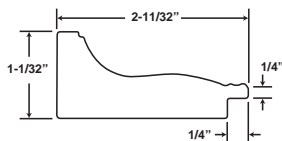
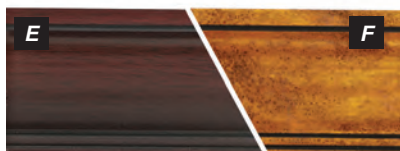

PART # FINISH
E PM-487-50 Mahogany
F PM-487-60 Antique Gold

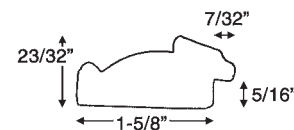

PART # FINISH
J PM-1105 Antique Gold

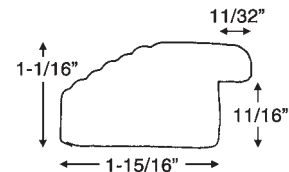

PART # FINISH
K PM-5040 Premier Walnut

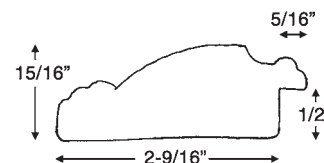
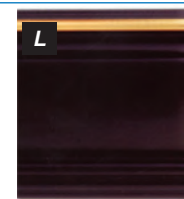

PART # FINISH
L PM-6170 Black w/Brass



Design Concepts
for Cable Shelving
& Signage Hardware

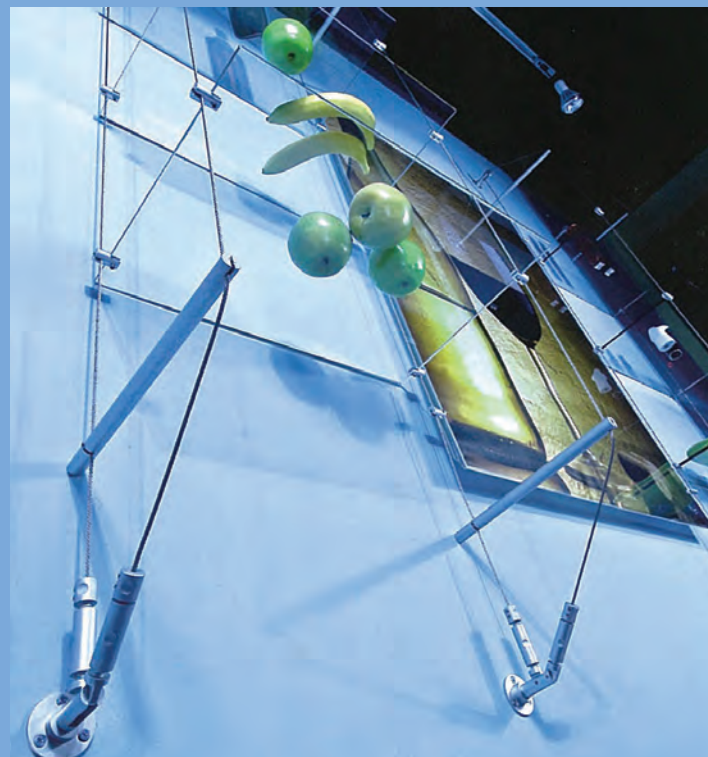
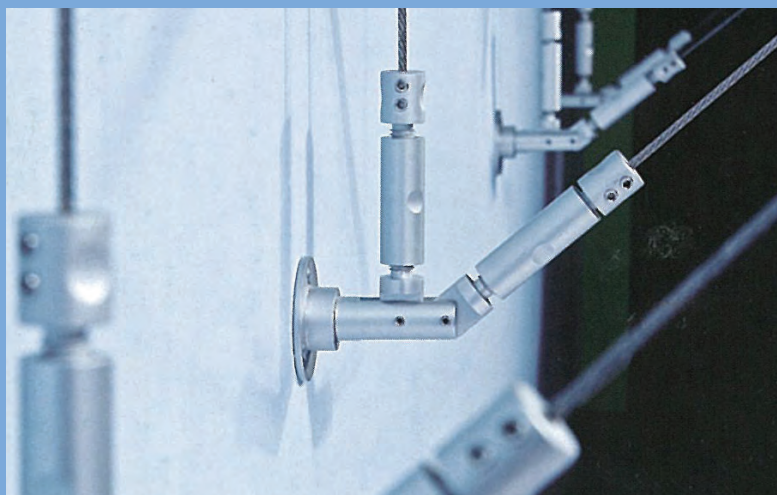

Product Features

- Solid Brass Construction available in:
 - Polished Chrome (PC*) and Satin Chrome (SC*)
- Load Rating 44 lbs. per shelf when mounted properly
- 2 Kit options to choose from – Shelf Kit or Sign Kit
- 304 grade stainless steel cable - 3mm thick

Wall to Wall Kits



Shelf Kit

CSK-WWSH-*

Shelf Kit Includes:

- ① Top Fixing (1)
- ② 6" or 8" Shelf Stabilizer (2)
- ③ 13 Ft. Cable (1)
- ④ Bottom Fixing (1)



Sign Kit

CSK-WWGN-*

Sign Kit Includes:

- ① Top Fixing (1)
- ② 13 Ft. Cable (1)
- ③ Bottom Fixing (1)

Wall to Floor Kits



Shelf Kit

CSK-WFSH-*

Shelf Kit Includes:

- ① Top Fixing (1)
- ② 6" or 8" Shelf Stabilizer (2)
- ③ 13 Ft. Cable (1)
- ④ Bottom Fixing (2)



Sign Kit

CSK-WFGN-*

Sign Kit Includes:

- ① Top Fixing (1)
- ② 13 Ft. Cable (1)
- ③ Bottom Fixing (1)

Note: 2 Sets needed for single unit display
Sign & Shelf Clamps sold separately, see page 177

Product Features

- Solid Brass Construction available in: Polished Chrome (PC*) and Satin Chrome (SC*)
- Load Rating 44 lbs. per shelf when mounted properly
- 2 Kit options to choose from – Shelf Kit or Sign Kit
- 304 grade stainless steel cable - 3mm thick

Floor to Ceiling Kit

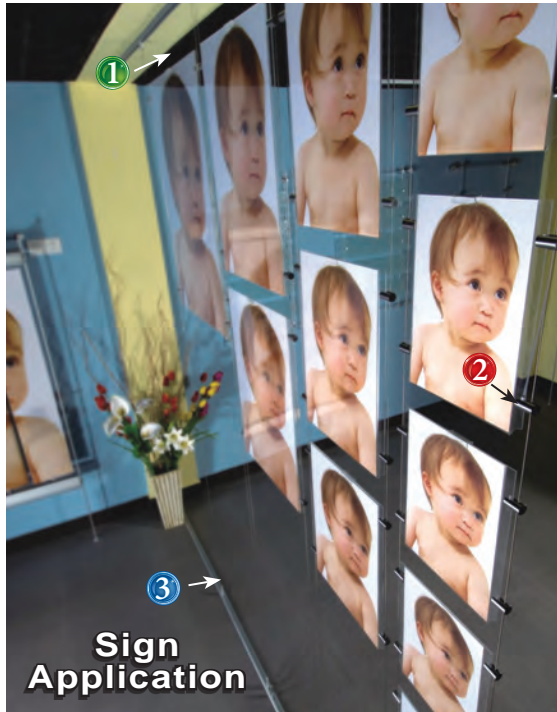

Sign Application

CSK-FC-*

This kit accommodates both shelving & sign applications

Kit Includes:

1



Top Fixing (1)

2



13 Ft. Cable (1)

3



Bottom Fixing (1)

NOTE:
2 Sets needed for single sign display

4 Sets needed for single shelf display



Shelf Application

SUSPENDED SIGN CABLE

Ceiling Mount Signage Set Kit

Product Features

- Load rating 400 lbs. per set of 2 cables
- Holds panel thickness up to: 5/16"
- 304 Grade Stainless Steel Cable
- 3mm thick Cable

1



Top Fixing (1)

2



Sign Connector (1)



13 Ft. Cable (1)
(sold separately)

NOTE: 2 Sets needed for single sign display

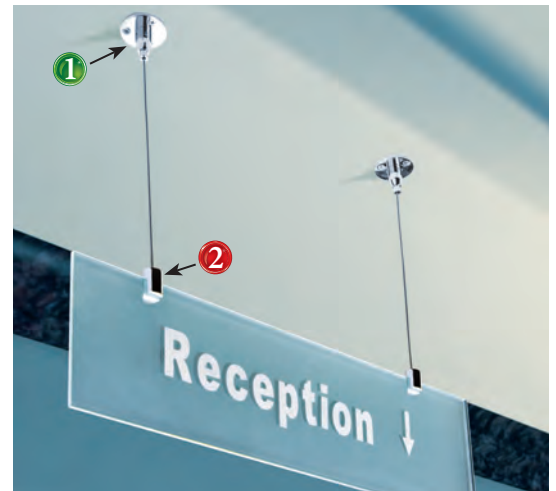

CSK-CSF-*

Components

Product Features

- Solid Brass Construction available in: Polished Chrome (PC*) and Satin Chrome (SC*)
 • Load Rating 44 lbs. per shelf when mounted properly • 304 grade stainless steel cable - 3mm thick and in 3 lengths

Top Fixings

Works for **Wall to Floor** and **Wall to Wall** Shelving applications



CSK-WWTF-*

Works for Suspended Signage applications



CSK-CSTF-*

ADJUSTABLE
 Works with **Wall to Wall** & **Wall to Ceiling** signage applications & all **Floor to Ceiling** applications



CSK-TF-*

Swivel
Straight

Bottom Fixings

Works for **Wall to Wall** Shelving applications



CSK-WWBF-*

Swivel



Straight

ADJUSTABLE

Works with all Signage applications, **Wall to Floor** & **Floor to Ceiling** shelving applications

CSK-BF-*

Cable



3mm thick cable available by the roll or in size cut lengths of 13 ft. & 26 ft.

PART #	LENGTH
CSK-CABLE-100	100'
CSK-CABLE	13'
CSK-CABLE-26	26'

OPTIONAL ACCESSORIES

Product Features

- Solid Brass Construction available in: Polished Chrome (PC*) and Satin Chrome (SC*)
 • Works with material up to 5/16" thick



6" OR 8" SHELF STABILIZER BAR
 Material: Aluminum

CSK-SSB-*



UNDERMOUNT SHELF SUPPORT

- Hole Size: 5/16" - 3/8" (8-10mm)
- Slot Size: 1/8" (3.5mm)

CSK-UM-*

Product Features

- Brass finish
- Used with aluminum channel system

TOGGLE FITTING



CSK-TOGGLE



Shelf Clamps



HORIZONTAL SINGLE SHELF CLAMP

CSK-SSC-*

HORIZONTAL DOUBLE SHLF CLAMP

CSK-DSC-*



Sign Clamps

HORIZONTAL SINGLE SIGN CLAMP

CSK-SSGC-*



HORIZONTAL DOUBLE SIGN CLAMP

CSK-DSGC-*



VERTICAL SINGLE SIGN CLAMP

CSK-CSSC-*



VERTICAL DOUBLE SIGN CLAMP
 7/16" Gap

CSK-DSSC-*

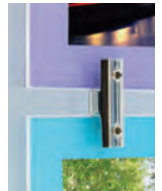

ADJUSTABLE SIGN/ SHELF CLAMPS
 Rotates for sign or shelf applications

PART #
CSK-ADJ-*



180°
Rotation

Hex Key

Set of 3 hex keys
 M4, M5 & M6

PART #
CSK-HEX



Cable Cutter



PART #
CSK-CUTTER

Need a fastener & an anchoring solution?
 see page

300 for Screws
 301 for Toggle® Anchors

CHANNEL MOUNT SIGNAGE SYSTEM FOR 3MM DIAMETER CABLE

Product Features

- Aluminum mounting channel can also be used for floor to ceiling applications
- 304 grade stainless steel cable - 3mm thick
- Holds up to 5/16" thick signs.
- Solid brass construction available in two finishes.
- Cable Load Rating- 400 lbs per set of two cables when mounting properly
- Aluminum Channel Load Rating- 110 lbs. over 6' 6" length when mounted properly.

Channel Mount Ceiling Set

Kit Includes:

①



Top Fixing (1)
Includes Toggle

②



Sign Connector (1)



Channel Mount Floor to Ceiling Set

Kit Includes:

①



Top Fixing (1)
Includes Toggle

②



Bottom Fixing (1)
Includes Toggle

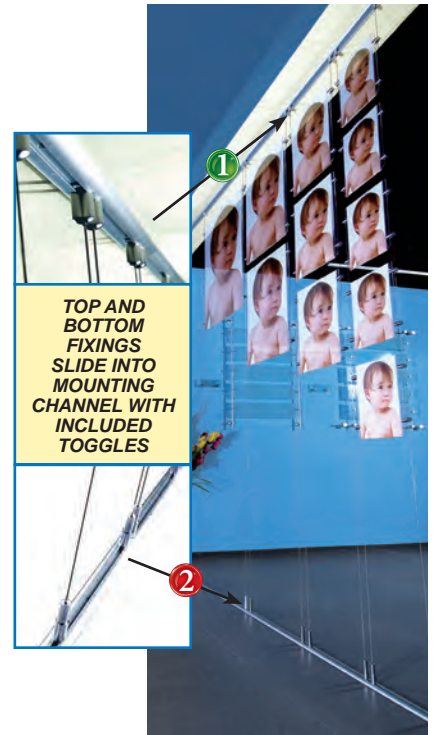

Items Sold Separately



Channel (1)
(sold separately)

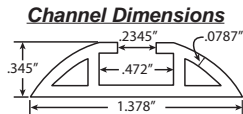

13 Ft. Cable (1)
(sold separately)

PART #	DESCRIPTION	FINISH
CSK-CHSF-PC	Channel Mount Suspended Sign Set	Polished Chrome
CSK-CHSF-SC	Channel Mount Suspended Sign Set	Satin Chrome
CSK-CHWF-PC	Channel Mount Floor to Ceiling Set	Polished Chrome
CSK-CHWF-SC	Channel Mount Floor to Ceiling Set	Satin Chrome
CSK-CABLE	13' Long x 3mm Thick 304 Stainless Steel Cable	-
CSK-ALU	6'6" Long Aluminum Mounting Channel	Clear Anodized

Sign & Shelf Clamps sold separately, see page 177



The System with profile since 1965

COMPATIBLE WITH OUR FOGA MODULAR EXHIBITION DISPLAY SYSTEM

Pictured

Cable Hardware

- CSK-WFSH-6-SC: See Pg. 175
- CSK-WWSH-6-PC: See Pg. 175
- CSK-SSC-SC: See Pg. 177
- CSK-SSC-PC: See Pg. 177
- CSK-CHWF-SC: See above
- CSK-ASH-8L: See Pg. 179
- CSK-ASH-11L: See Pg. 179
- CSK-SSGC-SC: See Pg. 177

FOGA

- Side- #153: See Pg. 194
- Top- #92: See Pg. 193
- Base- #194: See Pg. 193



CABLE SHELVING & SIGNAGE HARDWARE OPTIONAL DISPLAY ACCESSORIES

Works With 3MM Cable Sold On Page 177

Acrylic Sign Holder

(Non-Illuminated)

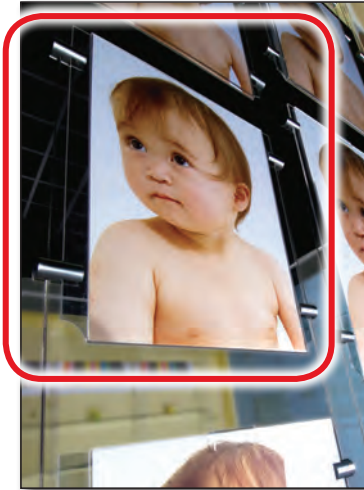

PRODUCT FEATURES:

- 1/8" Thick
- Polished Edges

Works With
Horizontal Sign Clamps
See Page 177

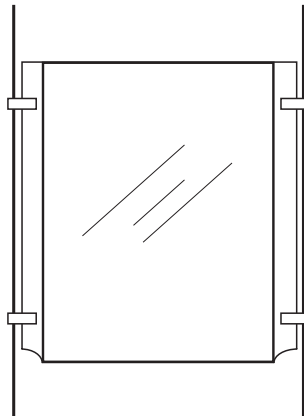
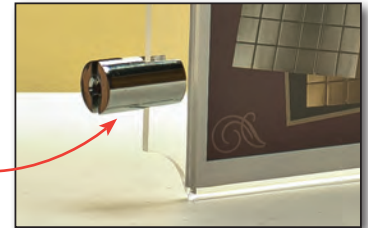

PART #	GRAPHIC SIZE	OVERALL SIZE
CSK-ASH-8P	8-1/2"W x 11"H	9-3/4"W x 11"H
CSK-ASH-8L	11"W x 8-1/2"H	12-1/4"W x 8-1/2"H
CSK-ASH-11P	11"W x 17"H	12-1/4"W x 17"H
CSK-ASH-11L	17"W x 11"H	18-1/4"W x 11"H
CSK-ASH-22P	22"W x 28"H	23-1/4"W x 28"H
CSK-ASH-22L	28"W x 22"H	29-1/4"W x 22"H
CSK-ASH-7P	7"W x 11"H	8-1/4"W x 11"H
CSK-ASH-7L	11"W x 17"H	12-1/4"W x 7"H

Clear Acrylic Angled Shelves



PRODUCT FEATURES:

- 1/4" Thick
- Polished Edges
- Adjust angle to your desired specification

* Works with CSK-ADJ*
Adjustable Sign Clamp
See Page 177

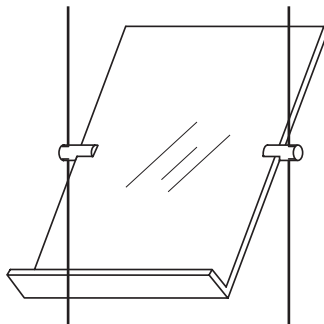

PART #	OVERALL SIZE
CSK-ASHF-9	9"W x 11-1/2"L x 1" Lip

Other Sizes & Colors Available, Please Inquire

CABLE SHELVING & SIGNAGE HARDWARE OPTIONAL DISPLAY ACCESSORIES

Works With 3MM Cable Sold On Page 177

Clear Folded Acrylic Display Shelves



PRODUCT FEATURES:

- .22" Thick Material
- Polished Edges

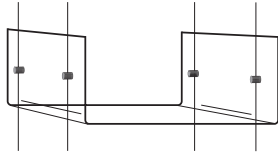

Polished Chrome
Mounting Clamps
Included

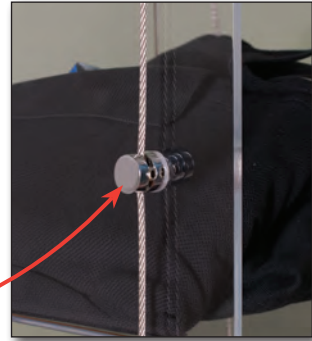

PART #	OVERALL SIZE
CSK-FSHF-12	12"D x 12"L x 6"H
CSK-FSHF-24	12"D x 24"L x 6"H

*Nominal Size

Clear Acrylic Display Cubes



PRODUCT FEATURES:

- .22" Thick Material
- Polished Edges

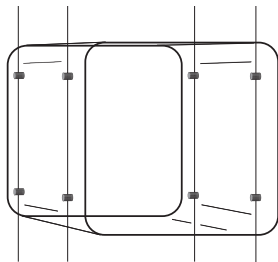

Polished Chrome
Mounting Clamps
Included

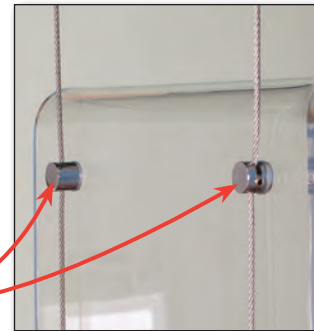

PART #	OVERALL SIZE
CSK-CUBE	12"W x 12"L x 12"D

*Nominal Size

Clear Acrylic Flat Shelves



PRODUCT FEATURES:

- 1/4" Thick Material
- Polished Edges

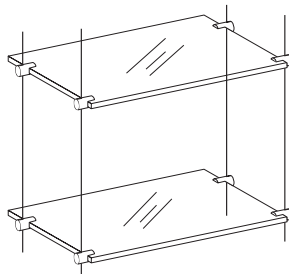

Shelf Clamps
Sold Separately
See Page 177

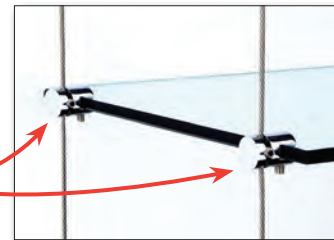

PART #	OVERALL SIZE
CSK-SHF-1212	12"W x 12"D
CSK-SHF-1224	24"W x 12"D

*Nominal Size

Other Sizes & Colors Available, Please Inquire

ECONOMY CABLE MOUNT WINDOW GRAPHIC

New



PRODUCT FEATURES:

- **1.5mm THICK** 304 Grade stainless steel cable supports up to 60 lbs.
- **ALUMINUM** universal fittings are hinged to allow or use in wall-to-wall and wall-to-floor applications
- For 8-1/2" x 11" and 11" x 17" graphics
- Non-illuminated kits can be used for single or double sided displays

Each kit contains:

- 2 universal top fittings
- 2 universal bottom fittings
- 2 cables - 6' 6" length
- 12 mounting screws & anchors
- 1 hex key
- 4 sign clamps per graphic holder
- 1/8" thick clear acrylic graphic holders w/polished edges



2 Graphic Kit

LANDSCAPE PORTRAIT

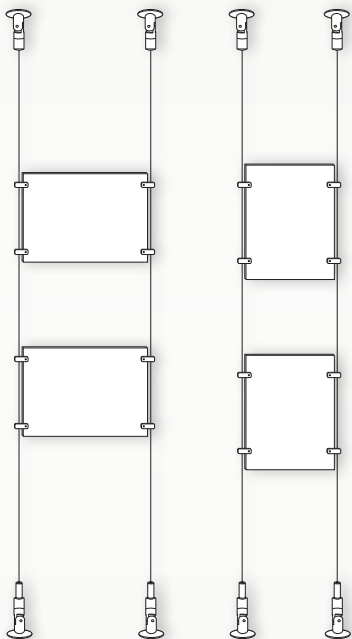

PART #	SIZE	TYPE
CSKE-LITKIT2-8*	8½" x 11"	Portrait (*-P)
CSKE-LITKIT2-11*	11" x 17"	Landscape (*-L)

3 Graphic Kit

LANDSCAPE PORTRAIT

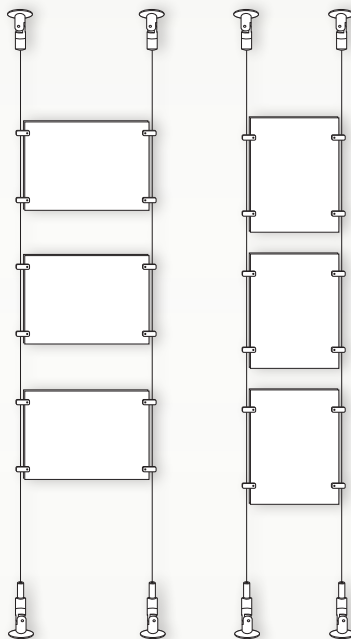

PART #	SIZE	TYPE
CSKE-LITKIT3-8*	8½" x 11"	Portrait (*-P)
CSKE-LITKIT3-11*	11" x 17"	Landscape (*-L)

4 Graphic Kit

LANDSCAPE PORTRAIT

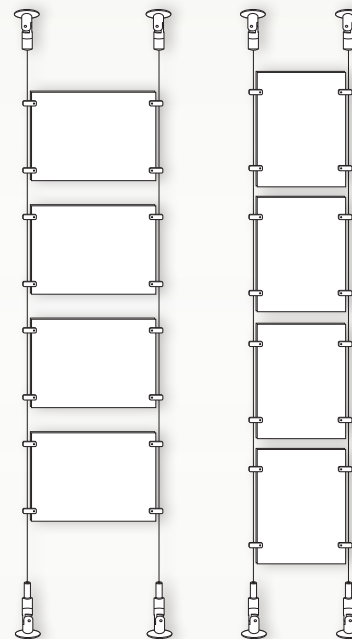

PART #	SIZE	TYPE
CSKE-LITKIT4-8*	8½" x 11"	Portrait (*-P)
CSKE-LITKIT4-11*	11" x 17"	Landscape (*-L)

DELUXE CABLE MOUNT WINDOW GRAPHIC KITS

New



PRODUCT FEATURES:

- **3mm THICK** 304 Grade stainless steel cable
- **SOLID BRASS** universal fittings are hinged to allow for use in wall-to-wall, wall-to-floor & floor-to-ceiling applications
- For 8-1/2" x 11" and 11" x 17" graphics
- Illuminated and Non-illuminated
- Non-illuminated kits can be used for double sided displays

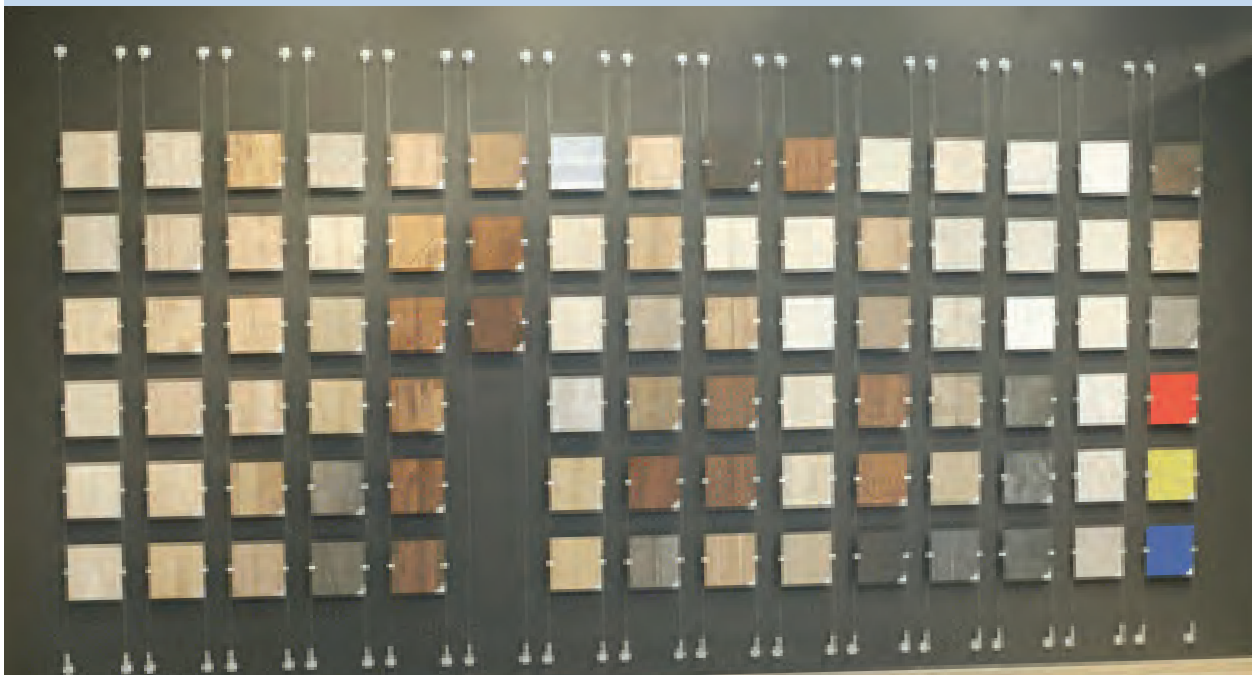

DELUXE CABLE MOUNT WINDOW GRAPHIC KITS

New

NON-ILLUMINATED KIT COMPONENTS



Each kit contains:

- 2 universal top and bottom fittings
- 2 cables - 13' length - 3mm thick
- 12 mounting screws & anchors
- 1 hex key
- 4 sign clamps per graphic holder
- 1/8" thick clear acrylic graphic holders w/polished edges

ILLUMINATED KIT COMPONENTS

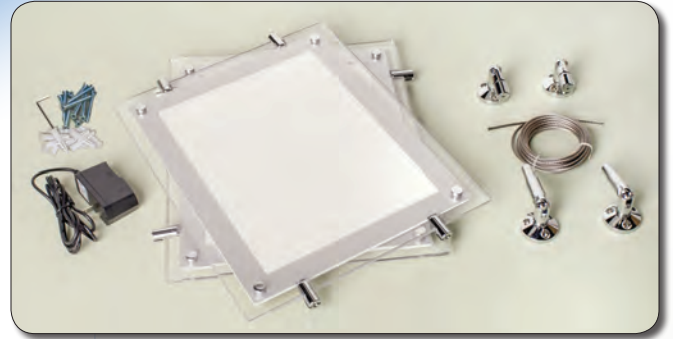

Each kit contains:

- 2 universal top and bottom fittings
- 2 cables - 13' length - 3mm thick
- 12 mounting screws & anchors
- 1 hex key
- 1 UL 12V power supply w/plug
- 1/8" thick clear acrylic graphic holders w/polished edges

2 Graphic Kit LANDSCAPE PORTRAIT

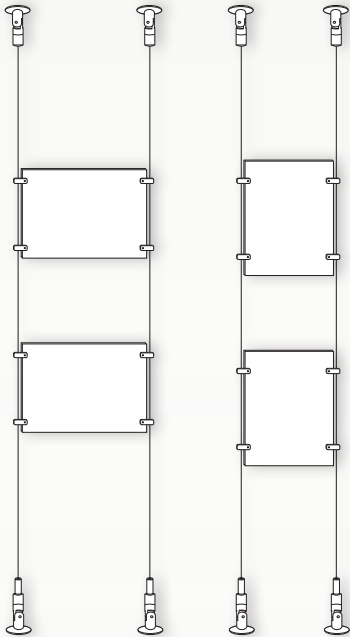

Non-Illuminated

PART #	SIZE	TYPE
CSK-LITKIT2-8*	8½" x 11"	Portrait (*-P)
CSK-LITKIT2-11*	11" x 17"	Landscape (*-L)

Illuminated

PART #	SIZE	TYPE
CSK-ILITKIT2-8*	8½" x 11"	Portrait (*-P)
CSK-ILITKIT2-11*	11" x 17"	Landscape (*-L)

3 Graphic Kit LANDSCAPE PORTRAIT

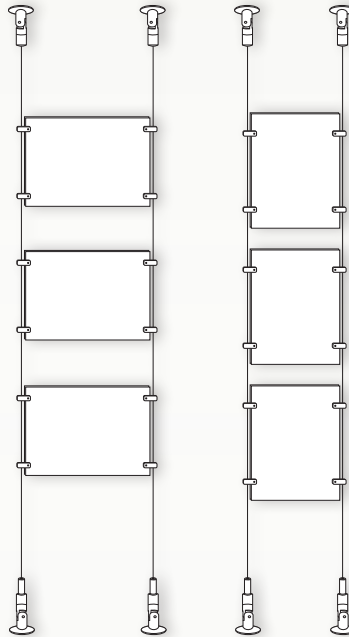

Non-Illuminated

PART #	SIZE	TYPE
CSK-LITKIT3-8*	8½" x 11"	Portrait (*-P)
CSK-LITKIT3-11*	11" x 17"	Landscape (*-L)

Illuminated

PART #	SIZE	TYPE
CSK-ILITKIT3-8*	8½" x 11"	Portrait (*-P)
CSK-ILITKIT3-11*	11" x 17"	Landscape (*-L)

4 Graphic Kit LANDSCAPE PORTRAIT

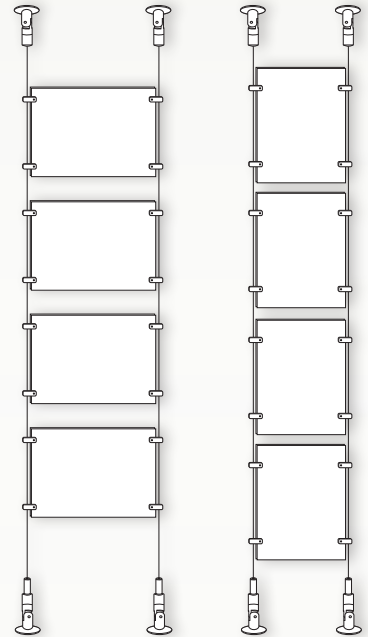

Non-Illuminated

PART #	SIZE	TYPE
CSK-LITKIT4-8*	8½" x 11"	Portrait (*-P)
CSK-LITKIT4-11*	11" x 17"	Landscape (*-L)

Illuminated

PART #	SIZE	TYPE
CSK-ILITKIT4-8*	8½" x 11"	Portrait (*-P)
CSK-ILITKIT4-11*	11" x 17"	Landscape (*-L)

ECONOMY CABLE SIGNAGE KITS & HARDWARE

New

PERFECT FOR CUSTOM SIGNAGE!

- ANY WIDTH AND SIZE
- SUPPORTS UP TO 60 LBS.

Product Features

- Aluminum construction with 1.5mm diameter 304 Grade stainless steel cable
- Satin Aluminum Finish

Multi-Use Signage Kit

- Universal top-bottom fixings can be used for wall-to-wall and wall-to-floor applications
- 6' 6" length of cable - can be field trimmed

Each kit contains:

- 1 top fixing
- 1 bottom fixing
- 1 cable - 6' 6" length - 1.5mm thick
- 6 mounting screws & anchors
- 1 hex key



CSKE-GN-ALU

Floor to Ceiling Signage Kit

- Floor-to-ceiling kit can be used with included toggle to work with our aluminum channel (sold separately)
- 13' length of cable - can be field trimmed

Each kit contains:

- 1 top fixing
- 1 bottom fixing
- 1 cable - 13' length - 1.5mm thick
- 2 toggle mounting screws & anchors
- 1 hex key



CSKE-FC-ALU

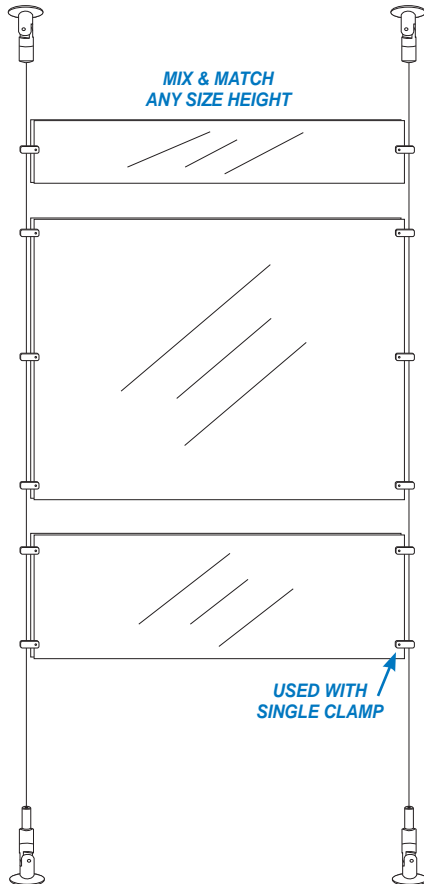

OPTIONAL ACCESSORIES

ALUMINUM CHANNEL

- For use with Floor to Ceiling Signage Kit

6'6" Long Aluminum Mounting Channel

Channel Dimensions

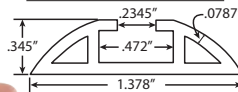

CSK-ALU

SIGN CLAMPS

- Holds material up to 5/16" thick

SINGLE



CSKE-SSGC-ALU

DOUBLE



CSKE-DSGC-ALU

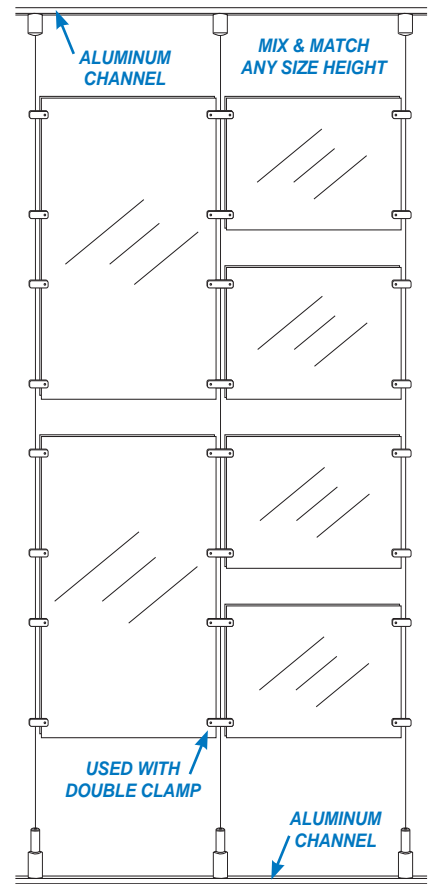

See pages 179 for Acrylic Sign Holders

LIGHT DUTY CHANNEL MOUNT HANGING SYSTEM

MATERIAL: ALL STEEL CONSTRUCTION - CABLE & TOGGLE HOOK

PRODUCT FEATURES:

- Aluminum channel works with both roller and toggle style hooks
- Carbon steel hooks in polished chrome finish include 4' of 2.5mm steel cable
- Hooks have push button adjustment along the length of cable
- Load rating of 26 lbs. per cable when properly installed



Hold down button to move hook along cable

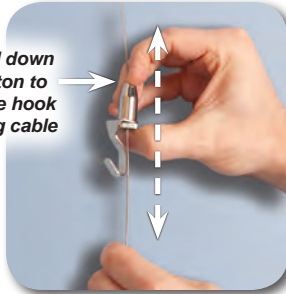

Twist knob to lock hook to cable

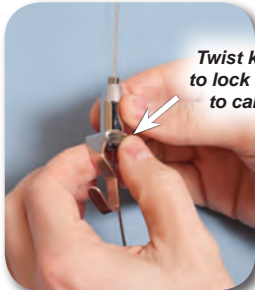

Need a fastener & an anchoring solution?
see page
300 for Screws
301 for Toggle® Anchors

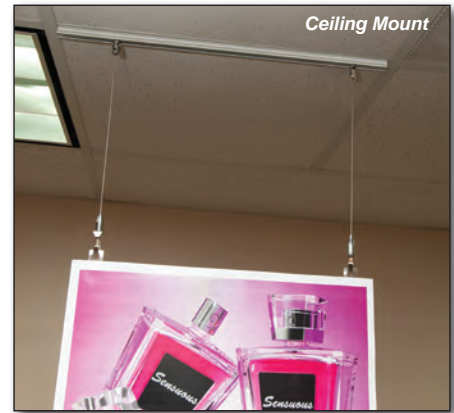

CLEAR ANODIZED ALUMINUM MOUNTING CHANNEL

6'6" length

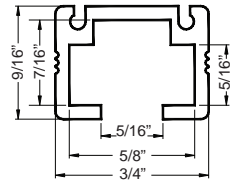

ROLLER STYLE HOOK
for side adjustment - ceiling application only
CSK-P45-01

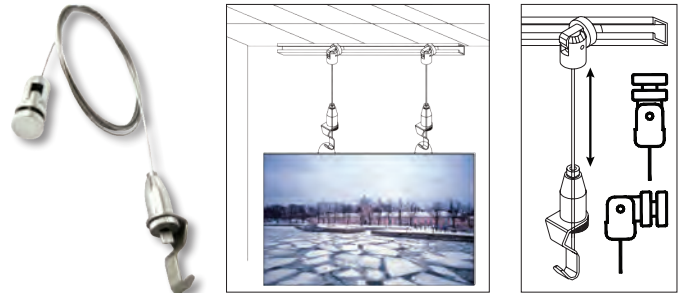

TOGGLE STYLE HOOK
for ceiling or wall mount application
CSK-P45-02

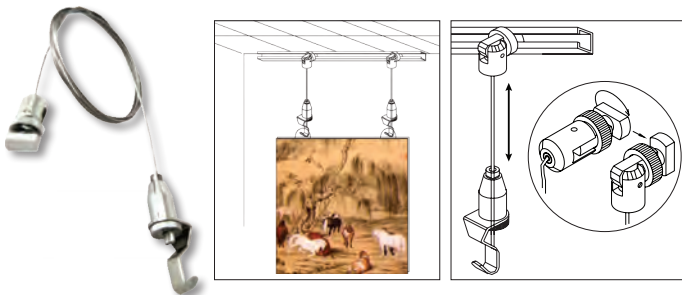

ADJUSTABLE TOGGLE STYLE HOOK
for ceiling or wall mount application
CSK-P45-04



LOOP END HOOK
for use with ceiling hooks **(Sold separately, see page 156)**
CSK-P45-03

HANG IT SIGN SYSTEM

MATERIAL: 1/8" THICK NON-GLARE CLEAR ACRYLIC



PRODUCT FEATURES:

- Can be used for both single sided and double sided applications
- Comes complete with all hanging hardware: (Pictured below)
 - 2 10 ft. length chains
 - 4 S-hooks (1-3/4" long)
 - 2 sets of ceiling clips (Right & Left)
- 3 sizes available

**COMPLETE SYSTEM
ALLOWS YOU TO HANG
SIGNAGE FROM CEILING,
MAXIMIZING VISIBILITY!**

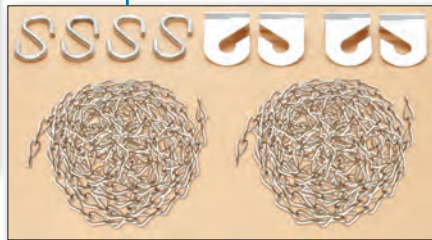
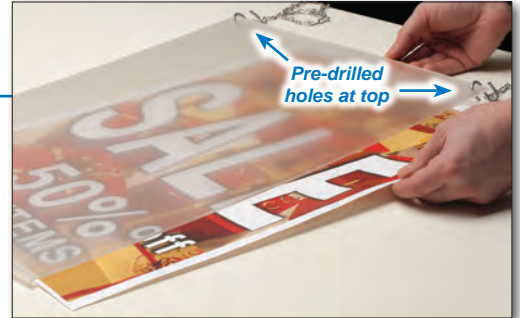

PART #	SIZE
CHS-2228-K	22" W x 28" H
CHS-2436-K	24" W x 36" H
CHS-3040-K	30" W x 40" H

WALL SIGN KITS



PRODUCT FEATURES:

- Complete sign kit includes:
 - 2 pieces of 1/8" thick pre-drilled acrylic with polished green edges
 - 4 standoffs (3/4" diameter x 3/4") in brushed stainless finish
 - 4 mounting screws
- Premium (-P) and Eco (-E) standoff kits available
- Available in a variety of sizes for uses ranging from directory signs to name plates

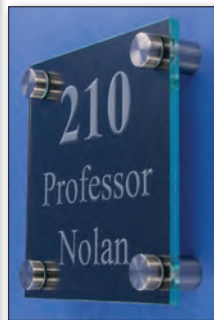

**Need a fastener & an
anchoring solution?
see page**

300 for Screws
301 for Toggler® Anchors

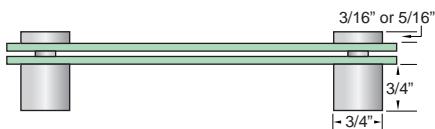

PART #	SIGN SIZE	LOCATION OF STANDOFFS	PREMIUM *(-P)	ECO *(-E)
STD-SIGN-63-*	6" W x 3" H	2 holes centered on short side		
STD-SIGN-66-*	6" W x 6" H	4 holes in the corners		
STD-SIGN-82-*	8" W x 2" H	2 holes centered on short side		
STD-SIGN-88-*	8" W x 8" H	4 holes in the corners		
STD-SIGN-811-*	8-1/2" W x 11" H	4 holes in the corners		

12 V
Sign
Material: Polished
Chrome Steel



LED MR16 ROD

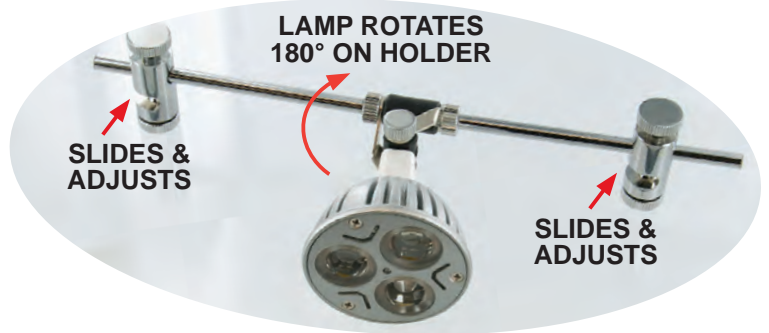

**As Bright As A
50W
Halogen Bulb**

PRODUCT FEATURES:

- 180° Rotation of lamp holder
- Built in heat sink
- Energy efficient
- Adjustable
- MR16, 12W bulb Included

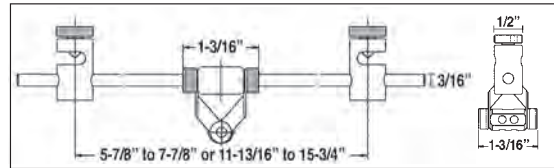

Works with our Cable Rail System, see pgs. 176-183

PART #	COLOR TEMP	WIDTH ADJUSTS FROM:	# OF LED CHIPS	TOTAL WATTAGE
CSK-MR16-100-WW	Warm White	5-7/8" to 7-7/8"	4	12W
CSK-MR16-100-CW	Cool White			
CSK-MR16-200-WW	Warm White	11-13/16" to 15-3/4"		
CSK-MR16-200-CW	Cool White			

LIGHTING SPECIFICATIONS

<p>COLOR TEMPERATURE</p> <p>Warm White Pure White Cool White</p> <p>3000K 6000K</p>	<p>BEAM SPREAD</p> <p>60°</p>	<p>Constant Voltage</p>	<p>LUMINESCENCE</p> <table border="1"> <thead> <tr> <th>COLOR</th> <th>LUMENS</th> </tr> </thead> <tbody> <tr> <td>Warm White</td> <td>950</td> </tr> <tr> <td>Cool White</td> <td>1000</td> </tr> </tbody> </table>	COLOR	LUMENS	Warm White	950	Cool White	1000	<p>COLOR RENDERING INDEX</p> <p>WW=80 CW=75</p>	<p>Average Rated For 50,000 Hours</p>
COLOR	LUMENS										
Warm White	950										
Cool White	1000										

UL POWER SUPPLIES

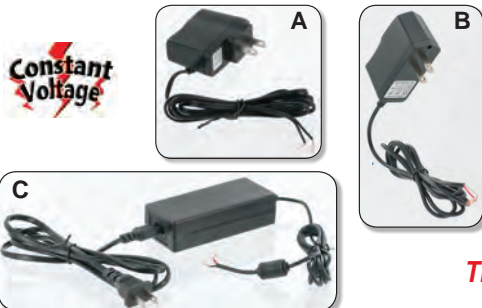

PART #	DESCRIPTION	WATTAGE	VOLTAGE	AMPS
A CSK-CLB-PW7	2-1/4"L x 1-7/8"W x 7/8"D Power Supply	7.2W	12V	.6A
B CSK-CLB-PW18	3-3/8"L x 1-7/8"W x 1-1/8"D Power Supply	18W	12V	1.5A
C CSK-CLB-PW36	4-5/8"L x 2"W x 1-1/4"D Power Supply	36W	12V	3A

These power supplies work with both the LED Crystal Box and LED MR16D Rod

12 V

Sign

Material:
Clear Vinyl



LED CRYSTAL LIGHT BOX

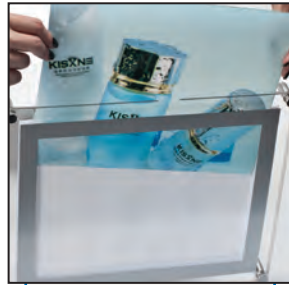

Portrait (P) or Landscape (L*) available, please specify*

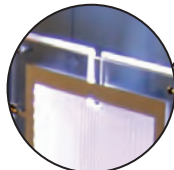

U-Shaped Cut Out

Cable Mount Hardware Sold Separately, See Pages 175-180



EACH FRAME INCLUDES:

- A) Light Box with
- B) Cable Connector

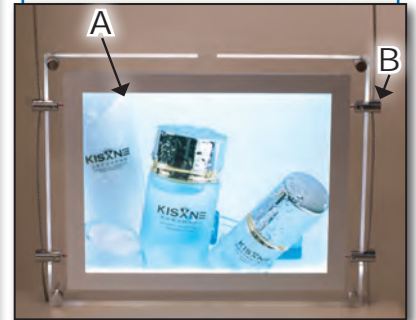

PRODUCT FEATURES:

- Super Thin Under 3/8"
- U-Shaped cut out in top for easy changing of graphics.

PART #	COLOR TEMP	GRAPHIC SIZE	REVEAL DIMENSIONS	OVERALL DIMENSIONS	# OF LED CHIPS	TOTAL WATTAGE
CSK-CLB-8-*	Cool White	8-1/2" x 11"	7-1/2" x 10-11/32"	11" x 13-1/2"	24	1.8W
CSK-CLB-11-*		11" x 17"	10-11/32" x 16-3/8"	13-1/2" x 19-1/2"	42	3.6W
CSK-CLB-16-*		16" x 20"	15-3/16" x 19-7/32"	18-11/32 x 22-3/8"	56	6W
CSK-CLB-22-*		22" x 28"	21-9/16" x 27-9/16"	24-3/4" x 30-3/4"	60	9W
CSK-CLB-24-*		24" x 36"	23-7/32 x 35-3/16"	26-1/2" x 38-1/2"	66	11W

*Other sizes available, please inquire**

LIGHTING SPECIFICATIONS		LUMINESCENCE		COLOR RENDERING INDEX	Average Rated For												
COLOR TEMPERATURE Warm White Pure White Cool White 6100K			<table border="1"> <thead> <tr> <th>COLOR</th> <th>LUMENS</th> </tr> </thead> <tbody> <tr> <td>CSK-CLB-8-*</td> <td>186</td> </tr> <tr> <td>CSK-CLB-11-*</td> <td>93</td> </tr> <tr> <td>CSK-CLB-16-*</td> <td>102</td> </tr> <tr> <td>CSK-CLB-22-*</td> <td>121</td> </tr> <tr> <td>CSK-CLB-24-*</td> <td>167</td> </tr> </tbody> </table>	COLOR	LUMENS	CSK-CLB-8-*	186	CSK-CLB-11-*	93	CSK-CLB-16-*	102	CSK-CLB-22-*	121	CSK-CLB-24-*	167		50,000 Hours
COLOR	LUMENS																
CSK-CLB-8-*	186																
CSK-CLB-11-*	93																
CSK-CLB-16-*	102																
CSK-CLB-22-*	121																
CSK-CLB-24-*	167																

UL POWER SUPPLIES

PART #	DESCRIPTION	WATTAGE	VOLTAGE	AMPS
A CSK-CLB-PW7	2-1/4"L x 1-7/8"W x 7/8"D Power Supply	7.2W	12V	.6A
B CSK-CLB-PW18	3-3/8"L x 1-7/8"W x 1-1/8"D Power Supply	18W	12V	1.5A
C CSK-CLB-PW36	4-5/8"L x 2"W x 1-1/4"D Power Supply	36W	12V	3A

These power supplies work with both the LED Crystal Box and LED MR16D Rod

