

2014



ORGANIZATION SYSTEMS

ORGANIZATION SYSTEMS

Pgs. 357-387

GARAGE ORGANIZATION



Great Wall PVC and Aluminum Slatwall System



Hooks - Slatwall



Aluminum Shelf Support Bracket



Racks - Slatwall



Baskets - Slatwall



Vanguard Closet Solutions

CLOSET ORGANIZATION



REV-A-SHELF

CLOSET ROD HARDWARE



Lazy Susans

KITCHEN STORAGE



Waste Containers

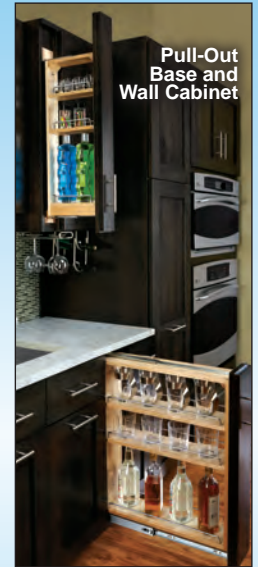

Pull-Out Base and Wall Cabinet



Tip-Out Trays

CLOSET LIGHT (LED Motion)	377	Colormatch Slatwall Mouldings	382	STEEL CLOSET ROD & HARDWARE	375
CLOSET ORGANIZATION		Colormatch Slatwall Screws	382	STEEL TUBING (Hangrail, Disp, Closet)	376
Baskets (Wire) - Pull-Out (Heavy Duty).....	373	High Density Heavy Duty PVC Slatwall.....	382	Closet Rod	376
Belt Butler (Rack)	372	Hooks - Slatwall.....	383-386	Fittings	376
Closet Rod - Pull Down	374	PVC Slatwall System (Great Wall)	382	SUSPENSION RAIL & BRACKETS	378
Clothes Rack (Spiral)	374	Racks - Slatwall	385	VANGUARD® CLOSET SOLUTIONS	
Electrical Plug Unit w/Light.....	371	Shelf Channel (Aluminum No Bow).....	387	Anchor & Pin System.....	380, 381
Hamper Baskets - Tilt-Out	373	Shelf Support Bracket (Aluminum)	387	Closet Rod Sockets.....	381
Ironing Board Covers (Replacement).....	371	Shelves - Slatwall	386	Closet Rods (Hemlock).....	379
Ironing Boards (Folding)	371	KITCHEN STORAGE		End Caps.....	379
Ironing Centers (Recess Mount).....	371	Blind Corner Optimizer (Chrome).....	363	Finishing Caps.....	381
Lazy Shoe Zen (His & Hers).....	374	Cookware Organizer.....	363	Installation Jig (For Shelf Supports)	381
Pants Rack - Pull-Out	373	Cutlery/Utility Tray Inserts.....	361	Rod & Shelf Supports	380
Shoe Rails (Wire)	373	Foil Wrap Holder (Base Cabinet).....	365	Shelf & Rod Center Supports	380
Tie & Belt Side Mount Rack.....	372	Pull-Out (Base Cabinet & Wall Filler)	364	Shelf Center Supports	380
Tie Butler (Rack).....	372	Rev-A-Lift.....	363	Shelf Joiners.....	379
Tie Rack (Easy Does It).....	372	Spice Rack (Wood Door Mount).....	361	Shelf Support (Economy)	381
Valet Rod (Standard).....	372	Tip-Out Trays.....	360	Shelf Supports	381
CLOSET ROD/HARDWARE (Residential)	377	Tra-Sta Organizer	361	WASTE CONTAINERS	
Closet Rod (Round & Oval).....	377	Tray Dividers	362, 365	Built-In	369
Closet Rod Flange (Round).....	377	KITCHEN STORAGE ACCESSORIES		Counter Mount.....	369
Supports (Round & Oval)	377	Cabinet Security Locks.....	362	Door Mount w/Soft Close Slides.....	367
GARAGE ORGANIZATION		Euro Hinge.....	360	RV Series	366
Aluminum Slatwall System (Great Wall).....	382	LAZY SUSANS		Top & Bottom Mount Wood Classic.....	368
Baskets - Slatwall	386, 387	Classic (Wood)	357	Under Sink Mount Double Container.....	369
Bins - Slatwall.....	387	Lazy Daisy (Polymer)	358	Waste Containers & Lids (Replacement)	370
Brackets - Slatwall.....	383	R•A•S (Polymer).....	359		

SEE PAGES 1007-1023 FOR A - Z INDEX

LAZY SUSANS



WOOD CLASSIC

PRODUCT FEATURES:

- 1-5/8" solid wood rim
- Finger jointed
- 5/8" thick maple tray bottom
- Chrome Hardware w/aluminum Bearings

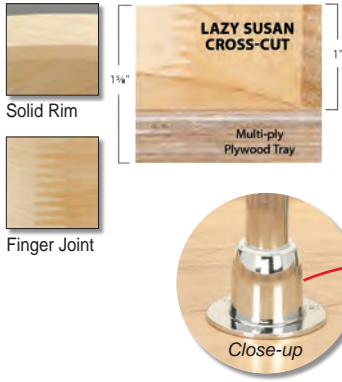

TRAY CONFIGURATIONS:

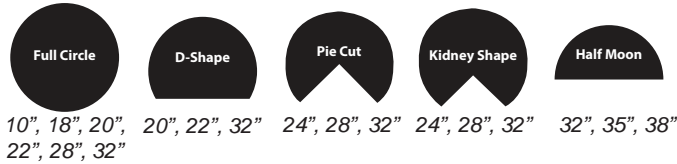

SINGLE SHELF SETS with swivel and bearings attached

SIZE	FULL CIRCLE (Independent)	D-SHAPE (Independent)	KIDNEY-SHAPE (Independent)
18" Dia.	4WLS001-18-B52	N/A	N/A
20" Dia.	4WLS001-20-B52	4WLS201-20-BS52	N/A
28" Dia.	4WLS001-28-B52	N/A	4WLS401-28-BS52
31" Dia.	N/A	4WLS201-31-BS52	N/A
32" Dia.	4WLS001-32-B52	N/A	4WLS401-32-BS52

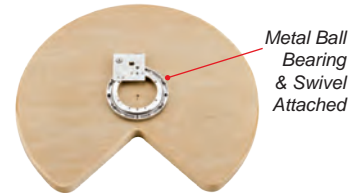

2 SHELF SET

Includes telescoping shaft 9-1/4" upper, and 22-1/2" lower shaft. Assembly to accommodate 26"-32" inner cabinet height, mounting hardware complete with screws and 1" diameter shaft system. The pie cut upper shelf is adjustable and the lower shelf is in a fixed position that cannot be altered.

SIZE	FULL CIRCLE (Independent)	D-SHAPE (Independent)	PIE-CUT (Dependent)	KIDNEY-SHAPE (Independent)
18" Dia.	4WLS072-18-52	N/A	N/A	N/A
20" Dia.	4WLS072-20-52	4WLS272-20-52	N/A	N/A
24" Dia.	N/A	N/A	4WLS942-24P-52	4WLS472-24-52
28" Dia.	4WLS072-28-52	N/A	4WLS942-28P-52	4WLS472-28-52
31" Dia.	N/A	4WLS272-31-52	4WLS942-31P-52	N/A
32" Dia.	4WLS072-32-52	N/A	N/A	4WLS472-32-52

HALF MOON 2 SHELF SET

Includes 2 shelves, 2 shelf supports, 2 positioning base, brackets, 17" shaft assembly, 2 pair of slides, template and installation instructions.

SIZE	MINIMUM CAB. HEIGHT	
32" Long Tray	12"	4WLS882-32-570
35" Long Tray	15"	4WLS882-35-570
38" Long Tray	18"	4WLS882-38-570



LAZY SUSANS

LAZY DAISY POLYMER

The Most Cost Effective Lazy Susan Available Today!

PRODUCT FEATURES:

- Unique patented snap pin design (see below)
- Ribbed tray surface
- Molded Polymer hubs
- Independently rotating shelves
Shelves turn independent of each other
- Polypropylene material
(32" is made of Polystyrene)
- Bottom mount [^]

Colors Available:

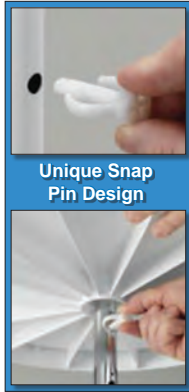

NOTE:
Use appropriate color code to complete the part number.



TRAY CONFIGURATIONS:

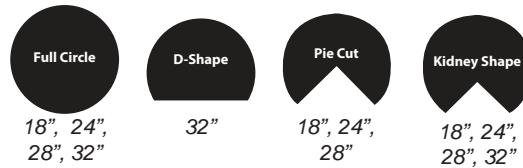

SINGLE SHELF SET

All mounting hardware is included.

SIZE	FULL CIRCLE (Independent)	D-SHAPE (Independent)	PIE-CUT (Dependent)	KIDNEY-SHAPE (Independent)
18" Dia.	LD-2061-18BM- [*] -1	N/A	Bulk Only-Inquire	Bulk Only-Inquire
24" Dia.	LD-2061-24BM- [*] -1	N/A	Bulk Only-Inquire	Bulk Only-Inquire
28" Dia.	LD-2061-28BM- [*] -1	N/A	Bulk Only-Inquire	Bulk Only-Inquire
32" Dia.	LD-2061-32BM- [*] -1	Bulk Only-Inquire	N/A	Bulk Only-Inquire

2 SHELF SET

Includes telescoping shaft and patented snap pin design. Will accommodate cabinet heights ranging from 26"-31".
All mounting hardware is included.

SIZE	FULL CIRCLE (Independent)	D-SHAPE (Independent)	[^] PIE-CUT (Dependent)	KIDNEY-SHAPE (Independent)
18" Dia.	LD-2062-18BM- [*] -1	N/A	LD-2942-18- [*] -1	LD-2472-18BM- [*] -1
24" Dia.	LD-2062-24BM- [*] -1	N/A	LD-2942-24- [*] -1	LD-2472-24BM- [*] -1
28" Dia.	LD-2062-28BM- [*] -1	N/A	LD-2942-28- [*] -1	LD-2472-28BM- [*] -1
32" Dia.	LD-2062-32BM- [*] -1	LD-2262-32BM- [*] -1	N/A	LD-2472-32BM- [*] -1

[^] These are standard mount lazy susans, not bottom mount

LAZY SUSANS

R•A•S POLYMER



PRODUCT FEATURES:

- Chrome shaft and hub
- Independently and dependently rotating shelves
Dependently rotating shelves: all shelves turn together at one time
Independently rotating shelves: shelves turn independent of each other
- Polystyrene material
- Metal shelf support hardware
- Bottom mount

Colors Available:

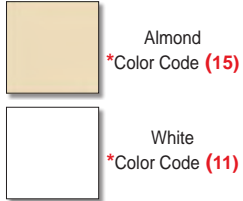

NOTE:
Use appropriate color code to complete the part number.



TRAY CONFIGURATIONS:



WEIGHT CAPACITY:

These Rev-A-Shelf Lazy Susans are tested to exceed BHMA Class 1 Specs: 20 lbs. per square foot at 75K cycles (120° rotation)

2 SHELF SET

Includes telescoping shaft dimensions are 12" for the upper and 21" for the lower shaft. Assembly to accommodate 26"-32" inner cabinet height.
The pie cut upper shelf is adjustable and the lower shelf is in a fixed position that cannot be altered.

SIZE	FULL CIRCLE (Dependent)	FULL CIRCLE (Independent)	D-SHAPE (Independent)	PIE-CUT (Dependent)	KIDNEY-SHAPE (Independent)
16" Dia.	N/A	6072-16*-52	N/A	N/A	N/A
18" Dia.	6012-18*-52	6072-18*-52	N/A	N/A	6472-18*-52
20" Dia.	6012-20*-52	6072-20*-52	6272-20*-52	N/A	N/A
22" Dia.	N/A	N/A	6272-22*-52	N/A	N/A
24" Dia.	6012-24*-52	6072-24*-52	N/A	6942-24*-52	6472-24*-52
28" Dia.	6012-28*-52	6072-28*-52	N/A	6942-28*-52	6472-28*-52
32" Dia.	N/A	6072-32*-52	N/A	N/A	6472-32*-52

3 SHELF SET

Includes telescoping shaft, dimensions are 12" for the upper and 36" for the lower shaft.
Assembly to accommodate 38"-46" inner cabinet height.

SIZE	FULL CIRCLE (Dependent) Inside Cab. Height = 38" - 46"	FULL CIRCLE (Independent) Inside Cab. Height = 26" - 32"
18" Dia.	6013-18*-526	6073-18*-536
20" Dia.	6013-20*-526	6073-20*-536

HALF MOON 2 SHELF SET

Includes 2 shelves, 2 shelf supports, 2 positioning base, brackets, 15-7/8" shaft assembly, 2 pair of slides, template and installation instructions.

SIZE	MINIMUM OPENING	
31" Long Tray	13-1/4"	6882-31*-570
33" Long Tray	16-1/8"	6882-33*-570
39" Long Tray	19-1/4"	6882-39*-570



TIP-OUT TRAYS

MATERIAL:

- Molded polymer in White or Almond finish

PRODUCT FEATURES:

False Front Tip-Out Tray w/Stop

- 2 trays per set, trays w/tabs on both ends

False Front Tip-Out Tray System (Std/Acc)

- Each set has 1 standard and 1 accessory tray and 2 pair of "Rev-A-Shelf SELF-HOLDIN"® hinges
- For use with 2 fronts on sink base cabinet



False Front Tip-Out Tray w/Stop

FALSE FRONT TIP-OUT TRAY w/STOP

PART #	COLOR	DESCRIPTION	SET PER CARTON	WEIGHT PER CARTON
6562-11-11-52	White	11" Trays w/Tab Stops (280mm)	1 set	.9 lbs.
6562-11-15-52	Almond	11" Trays w/Tab Stops (280mm)	1 set	.9 lbs.
6562-14-11-52	White	14" trays w/Tab Stops (360mm)	1 set	1.1 lbs.
6562-14-15-52	Almond	14" Trays w/Tab Stops (360mm)	1 set	1.1 lbs.

FALSE FRONT TIP-OUT TRAY SYSTEM (Std/Acc)

PART #	COLOR	DESCRIPTION	SET PER CARTON	WEIGHT PER CARTON
6572-11-11-52	White	11" Std/Acc Trays (280mm)	1 set	2 lbs.
6572-11-15-52	Almond	11" Std/Acc Trays (280mm)	1 set	2 lbs.
6572-14-11-52	White	14 1/4" Std/Acc Trays (362mm)	1 set	2.3 lbs.
6572-14-15-52	Almond	14 1/4" Std/Acc Trays (362mm)	1 set	2.3 lbs.



False Front Tip-Out Tray System

EXTRUDED TIP-OUT TRAYS

MATERIAL:

- Molded polymer in White or Almond finish

PRODUCT FEATURES:

- 36" (915mm) extruded tray, hinges, end caps & adhesive per pack number
- Custom cut trays to length & glue end caps on with Rev-A-Glue *included*

PART #	COLOR	DESCRIPTION	SET PER CARTON	WEIGHT PER CARTON
6551-36-11-52	White	1 Tray - 2 pr. Hinges & End Caps	1 set	2 lbs.
6551-36-15-52	Almond	1 Tray - 2 pr. Hinges & End Caps	1 set	2 lbs.
6551-36-11-50	White	1 Tray - 1 pr. Hinges & End Caps	1 set	1.5 lbs.
6551-36-15-50	Almond	1 Tray - 1 pr. Hinges & End Caps	1 set	1.5 lbs.



STAINLESS STEEL TIP-OUT TRAYS

MATERIAL:

- Polished Stainless Steel

PRODUCT FEATURES:

- Each tray comes with a pair of Rev-A-Shelf "SELF-HOLDIN"® hinges
- 2-1/8" deep, 3" in back, 1-1/4" high in front



PART #	DESCRIPTION
6581-10-52	10" Tray (250mm)
6581-11-52	11-1/4" Tray (280mm)
6581-13-52	13" Tray (330mm)
6581-14-52	14-1/4" Tray (360mm)
6581-16-52	16" Tray (400mm)
6581-19-52	19" Tray (480mm)
6581-22-52	22" Tray (559mm)
6581-25-52	25" Tray (635mm)
6581-28-52	28" Tray (711mm)
6581-31-52	31" Tray (788mm)

EURO HINGE

MATERIAL:

- Chrome Plated

PRODUCT FEATURES:

- Can be used for either frameless or framed cabinet applications. Opening angle can be adjusted from 45°-90°



PART #	DESCRIPTION
6552-ETH-10	Euro Hinge False Front Hinge



TRIMMABLE WOOD CUTLERY TRAY INSERTS

MATERIAL:

- Maple hardwood with a UV cured clear finish

PRODUCT FEATURES:

- Modern day drop-in solution
- Trimmable to fit various drawer sizes
- 2 depths to accommodate different drawer heights

PART #	DIMENSIONS
4WCT-1	14-5/8" W x 22 L x 2-7/8" H
4WCT-3	20-5/8" W x 22 L x 2-7/8" H
4WCT-1SH	14-5/8" W x 22 L x 2-3/8" H
4WCT-3SH	20-5/8" W x 22 L x 2-3/8" H

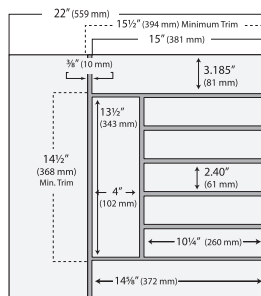

4WCT-3

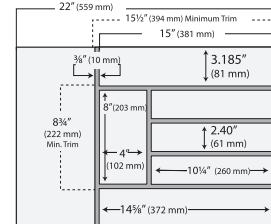

4WCT-1

TRIMMABLE WOOD UTILITY TRAY INSERTS

MATERIAL:

- Maple hardwood with a UV cured clear finish

PRODUCT FEATURES:

- Modern day drop-in solution
- Trimmable to fit various drawer sizes
- 2 depths to accommodate different drawer heights

PART #	DIMENSIONS
4WUT-1	18-1/2" W x 22" D x 2-7/8" H
4WUT-3	24" W x 22" D x 2-7/8" H
4WUT-1SH	18-1/2" W x 22" D x 2-3/8" H
4WUT-3SH	24" W x 22" D x 2-3/8" H

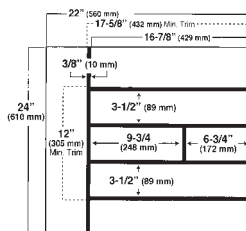

4WUT-3

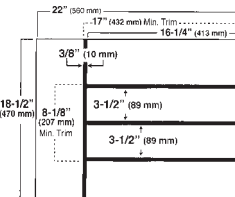

4WUT-1

WOOD DOOR MOUNT SPICE RACK

MATERIAL:

- Maple hardwood with a UV cured clear finish

PRODUCT FEATURES:

- Mounting brackets allow for 5" of adjustability
- Contains door mount and 4 screws for easy installation

PART #	DOOR WIDTH	DIMENSIONS
4SR-15	15"	10-1/2" W x 3-3/16" D x 21-1/4" H
4SR-18	18"	13-1/2" W x 3-3/16" D x 21-1/4" H
4SR-21	21"	16-1/2" W x 3-3/16" D x 21-1/4" H

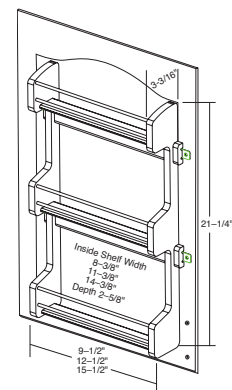

“TRA-STA” ORGANIZER

PRODUCT FEATURES:

- The perfect solution for cookie sheets, baking trays and muffin pans.
- Four pre-finished maple veneer dividers slide in grooved and pre-drilled top and bottom rails.
- Rails designed to be fastened in multiple locations to accept a variety of pots, pans or lids.
- Easily trimmable to fit any size cabinet.
- Dividers: 23-3/4"W x 23-3/4"H, Rails: 3/4"W x 24"L.
- Dividers are easily removed for simple cleaning of the cabinet.
- Includes 4 finished dividers and 8 drilled rails.

PART #
TS-2424



KITCHEN STORAGE



TRAY DIVIDERS

Now An Easy Way To Store Bulky Items!

MATERIAL:

- Steel with chrome or white finish

PRODUCT FEATURES:

U-Shaped Tray Divider:

- Simple bottom mount
- For wall or base cabinets
- Can use more than one in a cabinet
- Installs easily with the 4 screws included

Tray Divider w/Clips:

- Clips to wall or base of the cabinet with the 4 screw-in clips provided
- Can use more than one divider and allows you to customize your storage needs

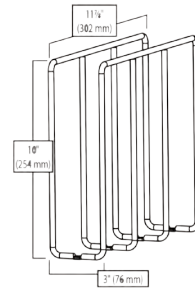

U-SHAPED TRAY DIVIDER

PART #	COLOR	DIMENSIONS
596-10CR-52	Chrome	3"W x 11-7/8"D x 10"H

TRAY DIVIDER WITH CLIPS

PART #	COLOR	DIMENSIONS
597-12-10	White	12" High Tray Dividers (305mm)
597-12CR-10	Chrome	12" High Tray Dividers (305mm)
597-18-10	White	18" High Tray Dividers (457mm)
597-18CR-10	Chrome	18" High Tray Dividers (457mm)

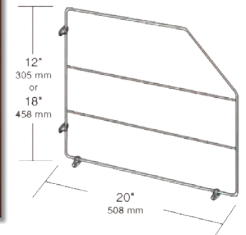

CABINET SECURITY

SAFEGUARD YOUR CABINETS FROM CURIOUS LITTLE HANDS!

PRODUCT FEATURES:

- Powerful magnetic lock that can attach to wood, glass, metal and particle board cabinets
- Lock and unlock by holding the magnetic key against the cabinet door
- Works with thicknesses ranging from 1/2" to 1-9/16"
- Locks include an unlocking device, extension slug and screws

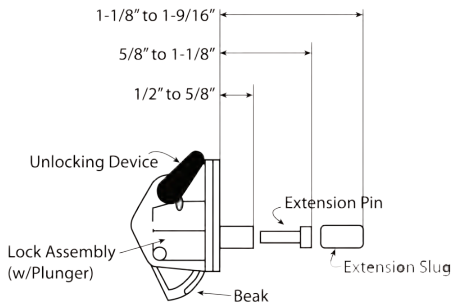

PART #	DESCRIPTION	SET PER CARTON
OPL-201	Lock Assembly	25
OPL-202	Magnetic Key	25

KITCHEN STORAGE

CHROME BLIND CORNER OPTIMIZER



PRODUCT FEATURES:

- Non handed and fits most 45" blind corner cabinets
- Features chrome accents, ball bearing slides and heavy gauge wire
- Includes 4 chrome baskets, full extension ball bearing slides and hardware
- Mounts to bottom of the floor
- Load capacity: 15 lbs. per basket



Fully Extended

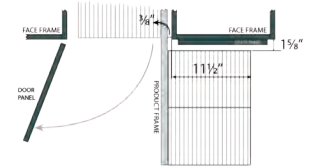

Partially Opened

PART

DIMENSIONS

5PSP-15-CR 26-1/4" (667mm) W x 20-1/4" (514mm) D x 21" (533mm) H

REV-A-LIFT

PRODUCT FEATURES:

- Spring loaded system gently brings small appliances to counter height
- Features built-in shock dampers and adjustable spring tension
- Can be used with many different widths with a minimum base cabinet frame opening of 12-1/2"
- Holds appliances up to 60 lbs.
- Must be installed in full height base cabinet, *shelf not included*



PART

DESCRIPTION

RAS-ML-HDCR Heavy Duty Mixer/Appliance Lift w/ Built in Shock Dampers

COOKWARE ORGANIZER

PRODUCT FEATURES:

- Top tier organizes lids and bottom tier features adjustable divider for a variety of pots and pans
- Designed for base 15 and 24 cabinets, this heavy duty chrome plated wire frame includes 100 lb. load rating full extension ball bearing slides
- Includes 2 u-brackets, adjustable rear mounting brackets and screw, but option door mounting bracket can be purchased separately



Storage for 12 lids



Storage for 7 lids

Adjustable Dividers

PART

CABINET

DIMENSIONS

5CW2-1222-CR BASE 15 11-3/4" (299mm) W x 22" (559mm) D x 18" (457mm) H

5CW2-2122-CR BASE 24 20-3/4" (527mm) W x 22" (559mm) D x 18-1/8" (460mm) H

RVDM17KIT ---



BASE CABINET & WALL FILLER PULL-OUT

Maximize Your Space By Adding Functional Storage Solutions!

MATERIAL:

- Maple hardwood with a UV clear coated finish

PRODUCT FEATURES:

- Adjustable shelving with chrome rails
- Ships completely assembled - simply attach the organizer to adjacent cabinets and add a filler front and decorative onlay for a completely functional pull-out!

BASE CABINET FILLER w/Full Extension Ball Bearing Slides

PART #	LOAD RATING	DESCRIPTION	DIMENSIONS
432-BF-3C	100 Lbs.	3" Filler Organizer	3" W x 23" D x 30" H
432-BF-6C	100 Lbs.	6" Filler Organizer	6" W x 23" D x 30" H
432-BF-9C	150 Lbs.	9" Filler Organizer	9" W x 23" D x 30" H

SOFT CLOSING BASE CABINET FILLER w/Full Extension Blum® Motion Soft Close Slides

Patented micro adjustment screw for precise door alignment.
Middle shelf is sold for extra support.

PART #	LOAD RATING	DESCRIPTION	DIMENSIONS
432-BFSC-3C	100 Lbs.	3" Filler Organizer	3" W x 23" D x 30" H
432-BFSC-6C	100 Lbs.	6" Filler Organizer	6" W x 23" D x 30" H

WALL FILLER PULL-OUT w/Full Extension Ball Bearing Slides

PART #	LOAD RATING	DESCRIPTION	DIMENSIONS
432-WF-3C	100 Lbs.	30" Tall 3" Filler Organizer	3" W x 11-1/8" D x 30" H
432-WF-6C	100 Lbs.	30" Tall 6" Filler Organizer	6" W x 11-1/8" D x 30" H
432-WF36-3C	100 Lbs.	36" Tall 3" Filler Organizer	3" W x 11-1/8" D x 36" H
432-WF36-6C	100 Lbs.	36" Tall 6" Filler Organizer	6" W x 11-1/8" D x 36" H
432-WF39-3C	100 Lbs.	39" Tall 3" Filler Organizer	3" W x 11-1/8" D x 39" H
432-WF39-6C	100 Lbs.	39" Tall 6" Filler Organizer	6" W x 11-1/8" D x 39" H
432-WF42-3C	100 Lbs.	42" Tall 3" Filler Organizer	3" W x 11-1/8" D x 42" H
432-WF42-6C	100 Lbs.	42" Tall 6" Filler Organizer	6" W x 11-1/8" D x 42" H



Base Cabinet Pull-out

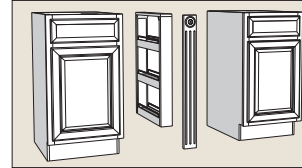

Wall Filler Pull-out

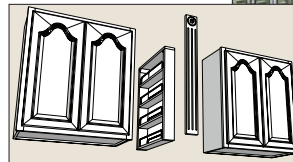

New



Soft Closing
Base Cabinet Filler

Base Cabinet Pull-out

KITCHEN STORAGE



BASE CABINET TRAY DIVIDER, FOIL WRAP HOLDER, BASE & WALL CABINET PULL-OUT

Stop Digging Inside The Cabinet & Simply Pull Out The Unit For Easy Access!

MATERIAL:

- Maple hardwood with a UV clear coated finish

PRODUCT FEATURES:

- Units glide on patented tri-slide which minimizes any side to side motion and provides stability when pulled out of the cabinet
- Full height door base cabinet is required
- Adjustable mounting brackets ensure that your doors are not damaged
- New adjustable rub bushings

Base Cabinet Tray Divider & Foil Wrap Holder

- 2 compartments for storage designed for 9" and 12" base cabinets
- Adjustable center rack allows you to customize your storage needs
- Tray dividers slide in and out of the unit easy and can accommodate many different items
- Included t-bars allows you to customize your storage needs

Base & Wall Cabinet Pull-Out

- Adjustable shelving with chrome rails
- Installation is easy - from the underside of the cabinet, simply screw the wood block to the bottom of the cabinet for complete stability



Tri-Slide

Adjustable Rub Bushings

Adjustable Mount Bracket

BASE CABINET TRAY DIVIDER & FOIL WRAP HOLDER

PART #	LOAD RATING	DESCRIPTION
447-BC-5C	100 Lbs.	5" Foil Wrap Holder/Tray Divider
447-BC-8C	100 Lbs.	8" Foil Wrap Holder/Tray Divider

BASE CABINET PULL-OUT

PART #	LOAD RATING	DIMENSIONS
448-BC-5C	100 Lbs.	5" W x 22-1/2" D x 25-1/2" H
448-BC-6C	100 Lbs.	6" W x 22-1/2" D x 25-1/2" H
448-BC-8C	100 Lbs.	8" W x 22-1/2" D x 25-1/2" H
448-BC-11C	150 Lbs.	11" W x 22-1/2" D x 25-1/2" H
448-BC-14C	150 Lbs.	14" W x 22-1/2" D x 25-1/2" H

WALL CABINET PULL-OUT

PART #	LOAD RATING	DIMENSIONS
448-WC-5C	100 Lbs.	5" W x 10-3/4" D x 25-1/2" H
448-WC-8C	100 Lbs.	8" W x 10-3/4" D x 25-1/2" H



Tray Divider & Foil Wrap Holder

T-Bar

Tray Slides In and Out Easily!



Base Cabinet Pull-Out



Wall Cabinet Pull-Out

WASTE CONTAINERS



RV SERIES

PRODUCT FEATURES:

- Easy bottom mount installation with 4 screws
- Each set includes container, frame, slides and screws
- Containers carry a limited lifetime guarantee

Colors Available:



RV SERIES - SINGLE WITH EURO SLIDES (75 lb. load rating)

PART #	COLOR/FINISH	QUART	DIMENSIONS
RV-814PB	White/White	20	8-1/2" W x 14-5/8" D x 16-5/8" H

RV SERIES - SINGLE WITH 3/4" EXTENSION SLIDES (75 lb. load rating)

PART #	COLOR/FINISH	QUART	DIMENSIONS
RV-9PB	White/White	30	9-1/2" W x 22" D x 19-1/4" H
RV-18PB-1	White/White	35	14-3/8" W x 22" D x 19-1/4" H
RV-12PB	White/White	35	10-5/8" W x 22" D x 19" H
RV-12PB-50	White/White	50	11-1/4" W x 22" D x 23-1/4" H

RV SERIES - SINGLE WITH 3/4" EXTENSION SLIDES & LID (75 lb. load rating)

PART #	COLOR/FINISH	QUART	DIMENSIONS
RV-12PBL	White/White	35	10-5/8" W x 22" D x 20-3/8" H

RV SERIES - SINGLE WITH FULL EXTENSION SLIDES (100 lb. load rating)

PART #	COLOR/FINISH	QUART	DIMENSIONS
RV-14PBS	White/White	20	14-5/8" W x 16" D x 16-3/8" H
RV-9PBS	White/White	30	9-1/2" W x 22" D x 19-1/4" H
RV-12PBS	White/White	35	10-5/8" W x 22" D x 19" H
RV-12KD-18CS	Black/Chrome	35	10-5/8" W x 22" D x 19-1/4" H
RV-12PB-50	White/White	50	12-1/4" W x 22" D x 23-1/4" H

RV SERIES - SINGLE WITH FULL EXTENSION SLIDES & LID (100 lb. load rating)

PART #	COLOR/FINISH	QUART	DIMENSIONS
RV-12PB-50S	White/White	50	12-1/4" W x 22" D x 24-1/4" H

RV SERIES - DOUBLE WITH FULL EXTENSION SLIDES (100 lb. load rating)

PART #	COLOR/FINISH	QUART	DIMENSIONS
RV-8PB-CRS	Silver/Chrome	20	8-5/8" W x 17-13/16" D x 16-3/4" H
RV-15PB-2S	White/White	27	11-13/16" W x 22-1/4" D x 19-1/8" H
RV-15KD-18CS	Black/Chrome	27	11-13/16" W x 22-1/4" D x 19-1/4" H
RV-15KD-17CS	Silver/Chrome	27	11-13/16" W x 22-1/4" D x 19-1/4" H
RV-18PB-2S	White/White	35	14-3/8" W x 22" D x 19-1/4" H
RV-18KD-18CS	Black/Chrome	35	14-3/8" W x 22" D x 19-1/4" H
RV-18KD-17CS	Silver/Chrome	35	14-3/8" W x 22" D x 19-1/4" H

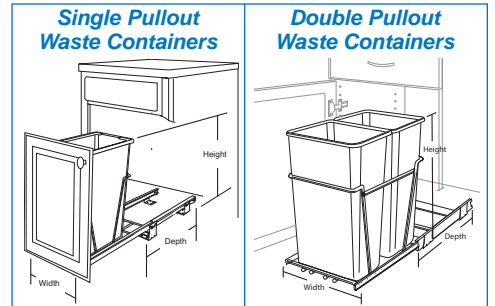

See page 370 for Replacement Waste Containers & Lids

RV DOOR MOUNT KIT

All RV series waste containers can be attached to the cabinet door for an easy one step process with the heavy-duty door mount kit. This system is considered the best in the industry with a six way adjustable door-mounting bracket for easy installation and simple job site adjustments. The RV-DM kit includes a complete set of brackets, fasteners and spacers for installation on any door style eliminating the need for a sub door panel.

PART #	FINISH
RV-DM-KIT	White
RV-DM17-KIT	Silver Epoxy

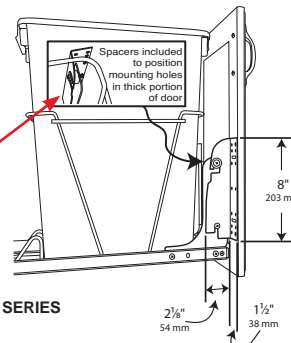

THIS KIT CAN BE ADDED TO ALL RV SERIES WASTE BINS AND HAMPERS

CONTAINS:

- 2- Product Members, 1- set-door brackets (1 left & 1 right),
- 2- 1/4" x 1/2" bolts, 2- 1/4" x 1/2" bolts w/washers, 4- #10 x 1/2" truss head screws, 4- nylock nuts

Spacer Kit:

- 2- 1/2" x 1" bolts, 2- 1/4" x 1" bolts w/washers, 4- 3/8" spacers

WASTE CONTAINERS



5349 SERIES DOOR MOUNT WASTE CONTAINERS WITH SOFT CLOSE SLIDES

PRODUCT FEATURES:

- Features heavy duty brushed aluminum soft closing sides that provide exceptional support and stability
- No side to side movement
- Fully adjustable (10" high) built in door mount frame
- Built in storage area for bags

Colors Available:



White



Silver



Stainless Steel



SINGLE DOOR MOUNT WASTE CONTAINERS

PART #	COLOR	QUART	DIMENSIONS
5349-15DM18-1SS	Stainless Steel	32	10-13/16" W x 18" D x 19-1/8" H
5349-15DM-1SS	Stainless Steel	32	10-3/4" W x 21-15/16" D x 19-1/8" H
5349-15DM-1	White	35	10-3/4" W x 21-15/16" D x 19-1/4" H
5349-15DM-117	Metallic Silver	35	10-3/4" W x 21-15/16" D x 19-1/4" H
5349-15DM18-1	White	35	10-13/16" W x 18" D x 19-5/16" H
5349-15DM18-117	Metallic Silver	35	10-13/16" W x 18" D x 19-5/16" H
5349-1550DM-1	White	50	10-3/4" W x 21-15/16" D x 23-1/8" H
5349-1550DM-117	Metallic Silver	50	10-3/4" W x 21-15/16" D x 23-1/8" H

DOUBLE DOOR MOUNT WASTE CONTAINERS

PART #	COLOR	QUART	DIMENSIONS
5349-1527DM-2	White	27	11-11/16" W x 22-1/4" D x 18-15/16" H
5349-1527DM-217	Metallic Silver	27	11-11/16" W x 22-1/4" D x 18-15/16" H
5349-18DM-2SS	Stainless Steel	32	14-13/16" W x 22-1/8" D x 18-13/16" H
5349-18DM-2	White	35	14-13/16" W x 21-7/8" D x 19-1/4" H
5349-18DM-217	Metallic Silver	35	14-13/16" W x 21-7/8" D x 19-1/4" H
5349-2150DM-2	White	50	14-13/16" W x 21-7/8" D x 22-5/16" H
5349-2150DM-217	Metallic Silver	50	14-13/16" W x 21-7/8" D x 22-5/16" H

HOLE SPREAD DIMENSIONS

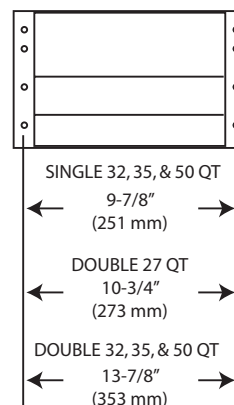

See page 370 for Replacement Waste Containers & Lids

DOOR MOUNT EXTENSION BRACKET

Mounts to the existing door bracket, but can be used if the standard mount will line up dangerously close to the door edge or a seam (A).

This bracket will allow you to extend and prevent the wood from splitting (B).

PART #	FINISH
5345-DM-KIT-52	Chrome

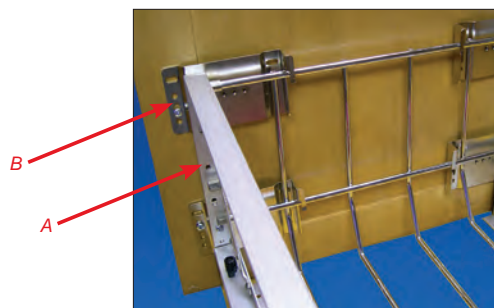

WASTE CONTAINERS



TOP & BOTTOM MOUNT WOOD CLASSIC SERIES

PRODUCT FEATURES:

- The sides are made from solid wood (maple) construction

Top Mount:

- Rear adjustable mounting brackets for variances in cabinet depth
- Includes pre-assembled door mounting brackets & full extension ball bearing or soft closing 100 lb. or 150 lb. rated slides with 1-1/2" overall travel
- The 35 quart single version includes a short polymer bin that provides an extra storage space for garbage bags

Bottom Mount:

- Includes pre-assembled door mounting brackets & full extension ball bearing or soft closing 100 lb. rated slides with 1-1/2" overall travel
- The containers are encased on in a durable wood base that the bottom of the cabinet for easy retrieval
- The single version includes a 7-3/4" bin that provides an extra storage space for bags

Colors Available:

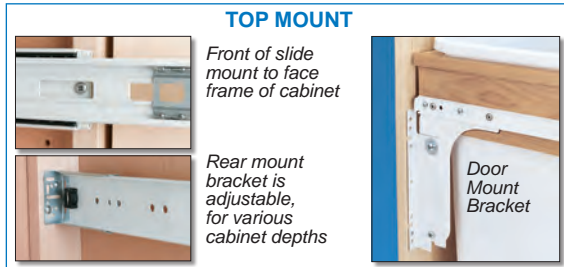
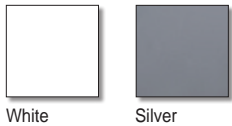

SINGLE TOP MOUNT PULL-OUT WASTE CONTAINER FOR 1-1/2" FACE FRAME

Includes white slides with a white polymer container (150 lbs.)

PART #	COLOR	QUART	DIMENSIONS
4WCTM-12DM-1	White	35	12" W x 22-3/4" D x 17-7/8" H
4WCTM-1550DM-1	White	50	14-1/4" W x 23-1/4" D x 21-3/4" H

New SINGLE SOFT CLOSE TOP MOUNT PULL-OUT WASTE CONTAINER FOR 1-1/2" FACE FRAME

Includes chrome finish slides with a silver metallic polymer container (100 lbs.)

PART #	COLOR	QUART	DIMENSIONS
4WCTM-12BBSCDM-1	Silver	35	12" W x 22-3/4" D x 17-7/8" H
4WCTM-1550BBSCDM-1	Silver	50	14-1/4" W x 23-1/4" D x 21-3/4" H



DOUBLE TOP MOUNT PULL-OUT WASTE CONTAINER FOR 1-1/2" FACE FRAME

Includes white slides with a white polymer container (150 lbs.)

PART #	COLOR	QUART	DIMENSIONS
4WCTM-15DM-2	White	27	12" W x 23-1/4" D x 17-3/4" H
4WCTM-18DM-2	White	35	15" W x 22-3/4" D x 17-7/8" H
4WCTM-2150DM-2	White	50	18" W x 23-1/4" D x 21-3/4" H

New SINGLE SOFT CLOSE TOP MOUNT PULL-OUT WASTE CONTAINER FOR 1-1/2" FACE FRAME

Includes chrome finish slides with a silver metallic polymer container (100 lbs.)

PART #	COLOR	QUART	DIMENSIONS
4WCTM-15BBSCDM-2	Silver	27	12" W x 23-1/4" D x 17-3/4" H
4WCTM-18BBSCDM-2	Silver	35	15" W x 22-3/4" D x 17-7/8" H
4WCTM-2150BBSCDM-2	Silver	50	18" W x 23-1/4" D x 21-3/4" H

SINGLE & DOUBLE BOTTOM MOUNT PULL-OUT WASTE CONTAINER

Includes white slides with a white polymer container (150 lbs.)

PART #	TYPE	COLOR	QUART	DIMENSIONS
4WC-15DM-1	Single	White	35	11-1/4" W x 21-3/4" D x 19-1/4" H
4WC-18DM-2	Double	White	35	14-1/4" W x 21-3/4" D x 19-1/4" H



See page 370 for Replacement
Waste Containers & Lids

WASTE CONTAINERS



STAINLESS STEEL UNDER SINK MOUNT DOUBLE WASTE CONTAINER

PRODUCT FEATURES:

- Stainless steel construction makes it ideal for kitchen, vanity and wet bar sink base usage
- Compact design enables it to fit around existing plumbing
- Includes 1 x 10 liter and 1 x 20 liter stainless steel container with covered lid, built-in handles, full extension slides and a door mount bracket for 8-785-30-DM-2SS

Color Available:



Stainless Steel



PART #	COLOR	DIMENSIONS
8-785-30-2SS	Stainless Steel	10-1/4" W x 18-3/4" D x 15-3/16" H
8-785-30-DM2SS	Stainless Steel	10-1/4" W x 18-3/4" D x 15-3/16" H

BUILT-IN WASTE BINS

PRODUCT FEATURES:

- As the cabinet door opens, the lifting mechanism raises the lid enabling the container to pivot out with the door
- Containers have built-in handle for easy removal
- Includes installation template and fasteners

Colors Available:

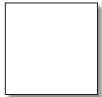

White



Silver



Stainless Steel



PART #	COLOR/MATERIAL	LITER	DIMENSIONS	MINIMUM CABINET OPENING
8-700411-20	White/Polymer Plastic	20	15 3/4" W x 7 1/4" D x 14"H	16-1/4"
8-010212-14	White/Lacquered Metal	14	11" W x 10 1/2" D x 13 3/4" H	13-3/4"
8-010412-15	White/Lacquered Metal	15	11-1/2" W x 11 1/2" D x 13 1/2" H	14-3/4"
8-010314-15	Stainless Steel	15	11" W x 10 1/2" D x 15 3/4" H	13-3/4"
5368-17-13	Silver/Plastic Polymer	13	11 1/4" W x 11" D x 13 3/4" H	14-1/4"



COUNTER MOUNT WASTE CONTAINER

PRODUCT FEATURES:

- Ideal for medical offices, retail counters or upscale outdoor kitchens
- Includes a removable container with handle
- Stainless steel lid and soft rubber inner ring designed to seal odors

Color Available:



Black

PART #	COLOR	LITER	DIMENSIONS
8-060-11SS	Black	11	Dia.: 12-1/4"W x 11-5/8"D
8-060-15SS	Black	15	Dia.: 12-1/4"W x 15-5/8"D



WASTE CONTAINERS



REPLACEMENT WASTE CONTAINERS & LIDS

MATERIAL:

- Polymer or stainless steel

PRODUCT FEATURES:

- If you need a replacement for an existing unit, then order here!

Colors Available:



White



Black



Green



Silver



Stainless Steel



REPLACEMENT WASTE CONTAINERS

PART #	COLOR	QUART	FOR
RV-20-52WH	White	20	RV-12PB-L
RV-20-52	White	20	RV-8PB* & RV-14PBS*
RV-1024W	White	27	5349*, RV-15* & 4WCTM* Series
RV-1024-17-52	Silver	27	5349*, RV-15* & 4WCTM* Series
6700-61-52	White	30	RV-9*
RV-35-52	White	35	5349*, RV-15* & 4WCTM* Series
RV-35-17-52	Silver	35	5349*, RV-15* & 4WCTM* Series
RV-35-18-52	Black	35	RV Series
RV-50-52	White	50	5349*, RV-15* & 4WCTM* Series
RV-50-17-52	Silver	50	5349*, RV-15* & 4WCTM* Series
5349-SS-52	Stainless Steel	32	5349 SS Series



New FLIP-UP WASTE CONTAINER LIDS

PART #	QUART	* COLORS AVAILABLE
RV-35-LID*-1	35	White, Silver, Black & Green
RV-50-LID*-1	50	White, Silver, Black & Green

STAINLESS STEEL TRASH LINERS



Material- 304 Stainless Steel

PRODUCT FEATURES:

- Brushed finish
- Perfect for use in restaurants, doctor's offices, hospitals, boats, RV's and public restrooms.
- Overlapping trim edge gives professional finished look.

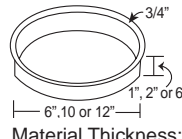
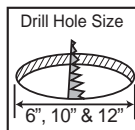

Material Thickness: .020"

PART #	DIAMETER	HEIGHT
TL-061		1"
TL-062	6"	2"
TL-066		6"
TL-101	10"	1"
TL-102		2"
TL-121	12"	1"

Other Sizes Available- Please Inquire

PLASTIC TRASH RECEPTACLE GROMMET

38 SERIES Material: Polystyrene



PART #	DIAMETER	COLOR
38BK	6"	Black
38WH	6"	White

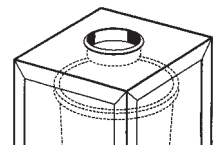
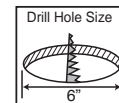

FOR HAZMAT & RECYCLABLES WASTE

2 New Finishes
Red & Green



PART #	DIAMETER	COLOR
38GR	6"	Green
38RD	6"	Red

CLOSET ORGANIZATION

FOLD-OUT IRONING BOARD



SURFACE AREA	
CIB-16CR (Closet Model)	
WIDTH	LENGTH
12" 305 mm	29-3/8" 746 mm
VIB-20CR (Vanity Cabinet)	
WIDTH	LENGTH
12" 305 mm	37-1/2" 953 mm
PRODUCT DIMENSIONS	
CIB-16CR (Closet Model)	
WIDTH	DEPTH
14-1/4" - 21" 362-534 mm	16" 407 mm
VIB-20CR (Vanity Cabinet)	
WIDTH	DEPTH
14-1/4" - 21" 362-534 mm	20" 508 mm



Rev-A-Shelf's unique pull-out ironing board can be retro fitted and folds away neatly into the space of a drawer. Simply open, unfold, and the board rises automatically with a locking device that keeps the board in place and even with the counter top.

PART #	DESCRIPTION	DIMENSIONS	FINISH
CIB-16CR	16" Fold Out Ironing Board	14-1/2"-21" W x 16" D x 4" H	Chrome
RAS-CIB-COVER-R-52	Replacement Cover (Closet)	-	Silver
VIB-20CR	20" Fold Out Ironing Board	14-1/2"-21" W x 20" D x 4" H	Chrome
RAS-VIB-COVER-52	Replacement Cover (Vanity)	-	Silver

RECESS MOUNT IRONING CENTER



Maple Finish not shown

- Raised panel door available in unfinished oak, maple or scratch resistant white
- Comes with a storage shelf, heat shield (for safe iron storage), swivel ironing board, hook and cover & pad set
- Sleeve board *included* with **IB-400-MP** only
- Sleeve board can be purchased separately^A
- Works with EU-1 electrical unit
- All installation hardware included
- 16"W x 47-3/4"H x 7"D outside dimensions
- 14-1/4"W x 46-1/4"H x 3-1/2"D cut out
- Board dimensions 47-1/2" x 11-1/2"

PART #	FINISH
IB-400	Oak
IB-400-MP	Maple
IB-420	White



New PART #
AIB-SLEEVE-BOARD

ELECTRICAL UNIT w/LIGHT

- UL listed.
- Bulb not included.
- Includes light fixture, plug & 30 minute timer.
- Works with recessed mount ironing centers only.
- Hardwire unit.



PART #
EU-1

REPLACEMENTS COVERS

- Works with both Surface & Recess Mount Ironing Centers.



PART # COLOR
COV-815-SIL Silver

LED MOTION CLOSET LIGHT

Linear
Material:
White Plastic w/
Frosted Lens Cover



**No WIRING
REQUIRED!**

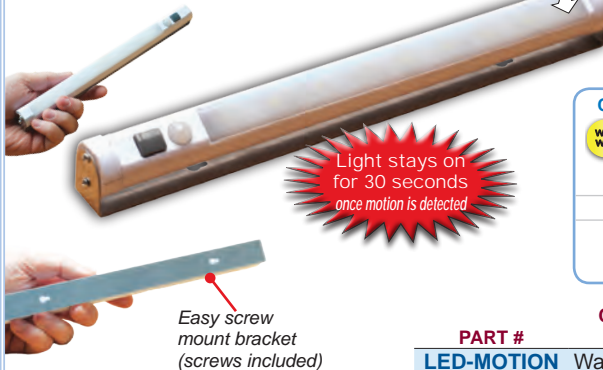

Light stays on for 30 seconds once motion is detected

Easy screw mount bracket (screws included)

PRODUCT FEATURES:

- Built-in motion sensor
- On/off switch
- 3 AA batteries included
- Pivots

Lighting Specification

Color Temperature		
Warm White	Pure White	Cool White
3000K		Warm White: 3000K
Lumens		Warm White: 27
Average Rated For 100,000 Hours		

PART #	COLOR TEMP	LENGTH	# OF LED CHIPS
LED-MOTION	Warm White	10"	9

CLOSET ORGANIZATION

TIEBUTLER® & BELTBUTLER® **New**



PRODUCT FEATURES:

- Solid wood with full extension ball bearing slides
- Designed to be installed under a shelf
- The Tie Butler can hold up to 68 ties without wrinkling and spillage
- The belt butler hold up to 42 belts, but with removable pegs, this can be customized to your needs

Colors Available: Natural*, Black (*B) & White (*W)

TIE BUTLER

PART #	DEPTH	# OF TIES	DIMENSIONS
CWTTR-12*1	12	38	5" W x 3-3/8" D x 11-7/8" H
CWTTR-14*1	14	44	5" W x 3-3/8" D x 13-7/8" H
CWTTR-16*1	16	52	5" W x 3-3/8" D x 15-7/8" H
CWTTR-20*1	20	68	5" W x 3-3/8" D x 19-7/8" H

BELT BUTLER

PART #	DEPTH	# OF BELTS	DIMENSIONS
CWTBR-12*1	12	22	4-1/2" W x 3-3/8" D x 11-7/8" H
CWTBR-14*1	14	26	4-1/2" W x 3-3/8" D x 13-7/8" H
CWTBR-16*1	16	34	4-1/2" W x 3-3/8" D x 15-7/8" H
CWTBR-20*1	20	42	4-1/2" W x 3-3/8" D x 19-7/8" H

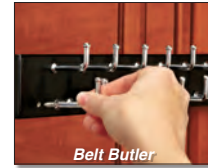
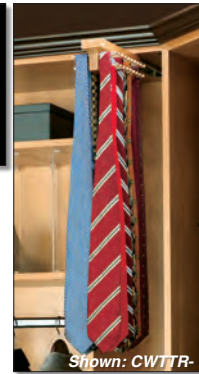

MATERIAL:

- Steel

PRODUCT FEATURES:

- Includes full extension ball bearing slides and screws for easy installation

Finishes Available: Chrome (*CR), Satin Nickel (*SN) & Oil Rubbed Bronze (*ORB)

TIE & BELT SIDE MOUNT

SIDE MOUNT TIE RACK

PART #	DEPTH	# OF BELTS	DIMENSIONS
TRC-12*	12"	23	2-1/2" W x 12" D x 1-7/8" H
TRC-14*	14"	25	2-1/2" W x 12" D x 3-7/8" H

SIDE MOUNT BELT RACK

PART #	DEPTH	# OF BELTS	DIMENSIONS
BRC-12*	12"	7 Hooks	2-1/2" W x 12" D x 1-7/8" H
BRC-14*	14"	9 Hooks	2-1/2" W x 12" D x 3-7/8" H



STANDARD VALET ROD **New**

PRODUCT FEATURES:

- Sturdy steel construction
- Extends out to 6"
- Installs easily with the 4 screws included



Finishes Available:

Chrome (*CR), Satin Nickel (*SN) & Oil Rubbed Bronze (*ORB)

PART #	DIMENSIONS
CVL-12*	11-7/8"-17-7/8" L

"EASY DOES IT" TIE RACK

PRODUCT FEATURES:

- Economical plastic screw mount tie rack
- Holds up to 16 ties
- Stay organized! Ties remain in place until lever is pressed

Colors Available:

Black (*BK), White (*WH) & Chocolate Pearwood (*CP)

PART #
TRC-EDI*

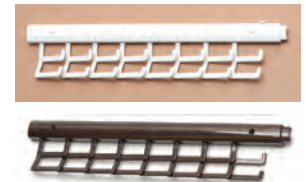

CLOSET ORGANIZATION

HEAVY DUTY PULL-OUT WIRE BASKETS & TILT-OUT HAMPER BASKETS



MATERIAL:

- Steel

PRODUCT FEATURES:

Heavy Gauge Pull-Out:

- Sleek pull-out design
- Installs easily on 32mm applications
- Includes full extension ball bearing slides with zinc finish.
- Oil rubbed bronze come with the same slide in a black finish

Tilt-Out Hamper Basket:

- Simply door mount basket rest to a bottom of a hinged cabinet
- The basket slides in slides out for easy access
- Constructed of 6.6mm heavy gauge wire

Finish Available: Chrome (*CR), Satin Nickel (*SN) & Oil Rubbed Bronze (*ORB)



Pull-Out Wire Basket
Shown: CB-241411-SN



Pull-Out Wire Basket
Shown: CB-18141ORB-2

STYLE	PART #	DIMENSIONS
PULL-OUT BASKETS - 14" DEEP	CB-181407*-2	18" W x 14" D x 7" H
	CB-181411*-2	18" W x 14" D x 11" H
	CB-181418*-2	18" W x 14" D x 18" H
	CB-241407*-2	24" W x 14" D x 7" H
	CB-241411*-2	24" W x 14" D x 11" H
	CB-241418*-2	24" W x 14" D x 18" H
PULL-OUT BASKETS - 16" DEEP	CB-301407*-2	30" W x 14" D x 7" H
	CB-301411*-2	30" W x 14" D x 11" H
	CB-301418*-2	30" W x 14" D x 18" H
	CB-181607*-2	18" W x 16" D x 7" H
	CB-181611*-2	18" W x 16" D x 11" H
	CB-181618*-2	18" W x 16" D x 18" H
PULL-OUT BASKETS - 20" DEEP	CB-241607*-2	24" W x 16" D x 7" H
	CB-241611*-2	24" W x 16" D x 11" H
	CB-241618*-2	24" W x 16" D x 18" H
	CB-301607*-2	30" W x 16" D x 7" H
	CB-301611*-2	30" W x 16" D x 11" H
	CB-301618*-2	30" W x 16" D x 18" H
PULL-OUT BASKETS - 20" DEEP	CB-182007*-2	18" W x 20" D x 7" H
	CB-182011*-2	18" W x 20" D x 11" H
	CB-182018*-2	18" W x 20" D x 18" H
	CB-242011*-2	24" W x 20" D x 11" H
	CB-242018*-2	24" W x 20" D x 18" H



Close up of Bayonet Mounting System for easy removal and reinstall.



The baskets rest upon the slide to prevent the torque twist that is inherent in other designs.



Tilt-Out Hamper Basket
Shown: CTOHB-211319-ORB-52



SPECIAL FEATURE
Ships and stores flat, reduces freight cost and shipping damage!

STYLE	PART #	STYLE
New	CTOHB-161319*-52	15-1/2" Tilt-out, 55 qt. capacity
	CTOHT-16-I-1	Tan cloth liner
TILT-OUT HAMPER	CTOHB-16-I-1	Black cloth liner
	CTOHB-211319*-52	20-1/2" Tilt-out, 55 qt. capacity
	CTOHT-21-I-1	Tan cloth liner
	CTOHB-21-I-1	Black cloth liner

WIRE SHOE RAILS

PRODUCT FEATURES:

- Heavy gauge steel storage solution
- Designed to fit 5mm mounting holes on 32mm spacing

Finish Available:

Chrome (*CR), Satin Nickel (*SN)
& Oil Rubbed Bronze (*ORB)



PART #	SIZE	DIMENSIONS
CSR-17*-10	17" Rail	17" L x 2-1/4" H
CSR-23*-10	23" Rail	23" L x 2-1/4" H
CSR-29*-10	29" Rail	29" L x 2-1/4" H
CSR-35*-10	35" Rail	35" L x 2-1/4" H

PULL-OUT PANTS RACK

PRODUCT FEATURES:

- Distinctive movable fingers for easy access (fingers are 17-3/8" long)
- Set includes frame assembly chrome rods and full extension slides

Finish Available: Chrome



PART #	CAPACITY	DIMENSIONS
PSC-1814CR	9 Pants	17-1/2"-18-1/8" W x 14"D x 3" H
PSC-2414CR	13 Pants	23-3/4"-24-1/2" W x 14"D x 3" H
PSC-3014CR	16 Pants	29-3/4"-30-1/2" W x 14"D x 3" H

CLOSET ORGANIZATION



PULL DOWN CLOSET ROD with ADJUSTABLE HANDLE

PRODUCT FEATURES:

- Minimum of 14" closet depth required
- Adjustable rod can accommodate a variety of widths
- Adjustable handle is ideal for handicap accessible applications and can be adjusted from 34" to 50"

PART #	DIMENSIONS
CPDR-1826	18" - 26" W
CPDR-2635	26" - 35" W
CPDR-3548	35" - 48" W



Push button mechanism for adjusting handle length



Pivoting Feature!

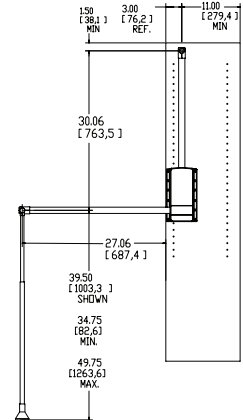

SPIRAL CLOTHES RACK

PRODUCT FEATURES:

- 360 degree turning radius
- Adjustable height of 72-1/2" to 82"
- Ability to hang 40 single items
- Includes stabilizer bar, post, pivot hardware and mounting hardware

PART #	DIMENSIONS	FINISH
SHR-3684	23" W x 72-1/2" - 84" H	Chrome

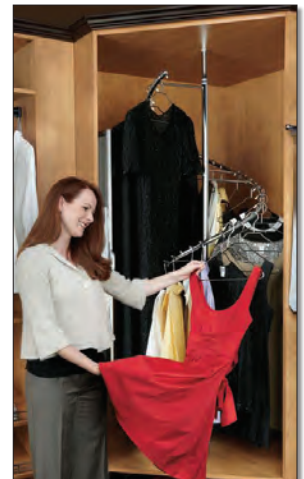
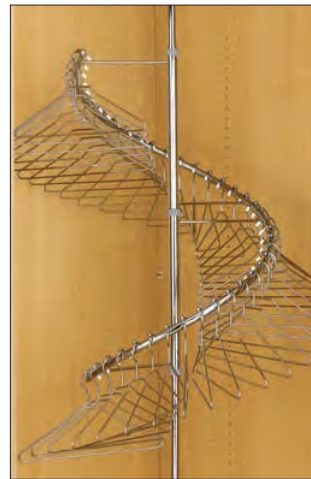
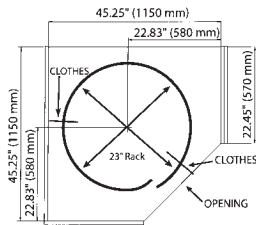

HIS & HERS LAZY SHOE ZEN New

PRODUCT FEATURES:

- 360 degree turning radius
- High grade plastic shoe horn
- Height adjustable for different size shoes
- Built-in detent ensures your shoes are always facing out

WOMEN'S LAZY SHOE ZEN

PART #	# OF SHELVES	SHOE CAPACITY	VERTICAL ADJUSTMENT	DIMENSIONS
CLSZ-W3-55-1	3	15 Pairs	3.5"	18" W x 18" D x 54-62" H
CLSZ-W5-96-1	5	25 Pairs	3.5"	18" W x 18" D x 95-103" H

MEN'S LAZY SHOE ZEN

PART #	# OF SHELVES	SHOE CAPACITY	VERTICAL ADJUSTMENT	DIMENSIONS
CLSZ-M3-55-1	3	12 Pairs	5"	18" W x 18" D x 54-62" H
CLSZ-M5-96-1	5	20 Pairs	5"	18" W x 18" D x 95-103" H

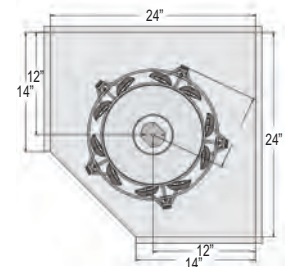
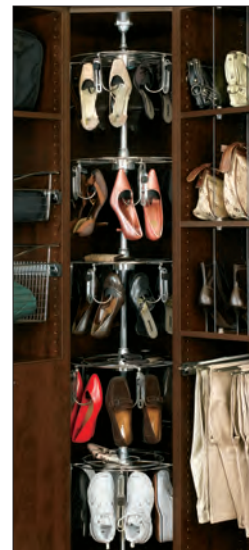

STEEL CLOSET ROD & HARDWARE

BRASS FINISH

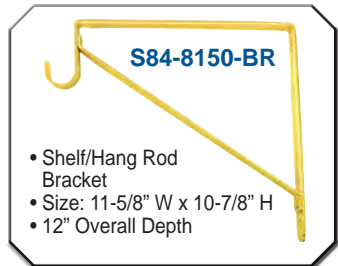

BRUSHED NICKEL FINISH

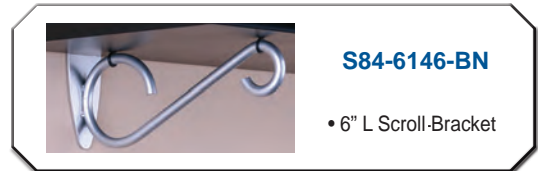

BRONZE FINISH

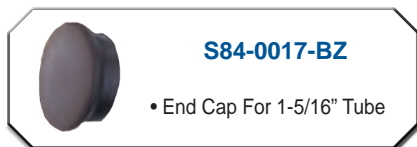

WHITE EPOXY COATED FINISH

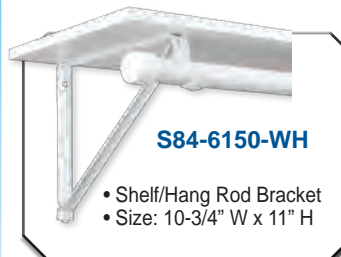

STEEL TUBING FOR HANGRAIL, DISPLAYS OR CLOSET APPLICATIONS

STEEL OVAL 1-1/8" x 9/16" (30mm x 15mm) CLOSET ROD TUBING

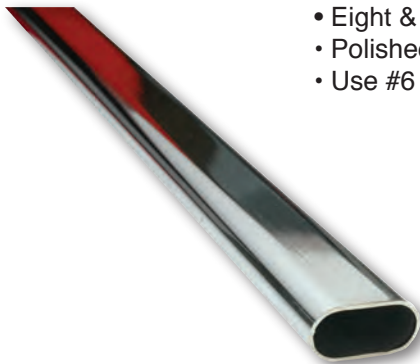

- Eight & ten foot lengths.
- Polished chrome finish.
- Use #6 flathead screws.

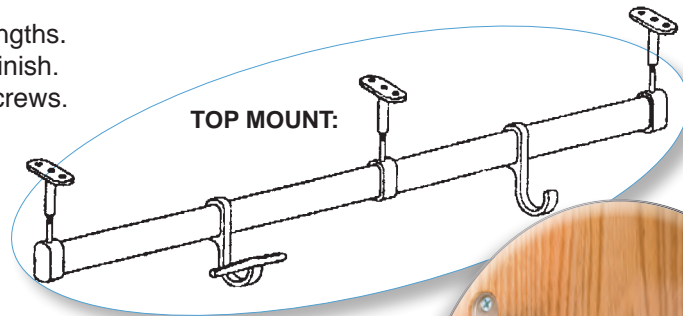

PART #	GAUGE
S84-320-8	20 gauge
S84-320-10	22 gauge



1-1/8" x 9/16" (30mm x 15mm) FITTINGS

S84-160
Hook



S84-161
Hook
With Bar



S84-250
Ceiling Bracket
End
(Adj. Height)
1-3/4" Base

3-1/4"
Closed
4-1/4"
Opened



S84-260
Ceiling Bracket
Center
(Adj. Height)
1-3/4" Base

3-1/4"
Closed
4-1/4"
Opened



S84-3015CS-BC
Projection - 3"



S84-802NP
Nickel
Closet Rod
Support
Screw Type



S84-190
Wall Bracket Center
Projection - 3-3/4"



S84-170
Wall Bracket Right End
Projection - 3-3/4"



S84-180
Wall Bracket Left End
Projection - 3-3/4"



STEEL ROUND BRITE CHROME 5/8" CLOSET ROD

- 4 foot lengths.

PART #	LENGTH
A1BC	48"

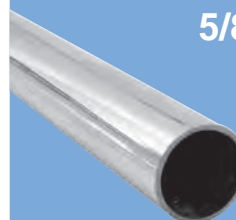

STEEL 5/8" U-FLANGE FOR 5mm HOLE

- Nickel Closet Rod Support
32mm System

PART #
S84-803NP



1-1/8" x 9/16" (30mm x 15mm) OVAL END CAP

- Black CDPC with Chrome plated top.
- 14 - 19 Gauge.

S58-3015-CH



For more tubing, see page 123

ALUMINUM OVAL 1-3/16 X 19/32" CLOSET ROD

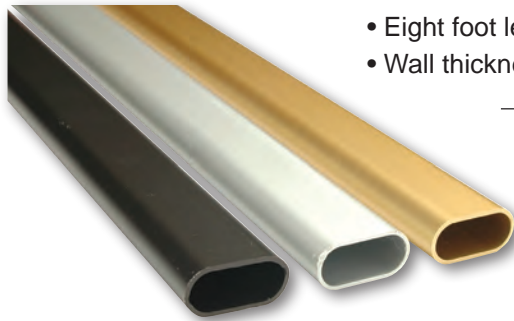

- Eight foot lengths
- Wall thickness 1/16"

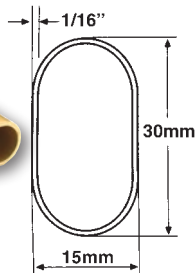

PART #	FINISH
S84-3015-SB	Satin Brass
S84-3015-SC	Satin Chrome
S84-3015-ORB	Oil Rubbed Bronze

OVAL CLOSET ROD SUPPORTS FOR 19/32" OVAL CLOSET ROD

5mm PIN

SCREW MOUNT

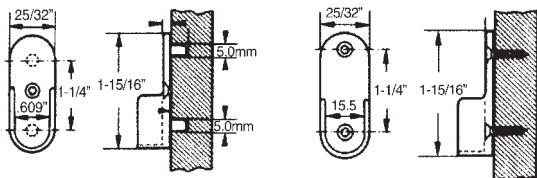

- 25/32" x 1-15/16" Size

PART #	MOUNTING	FINISH
S84-3015P-SB	5mm Pins	Satin Brass
S84-3015P-SC		Satin Chrome
S84-3015P-ORB		Oil Rubbed Bronze
S84-3015S-SB	Screw Mount	Satin Brass
S84-3015S-SC		Satin Chrome
S84-3015S-ORB		Oil Rubbed Bronze

Screws sold separately. Use #8 x 3/4" Flathead drywall screw, Part # SCR-8750FHZ, sold on page 300.

OVAL ROD CENTER SUPPORTS FOR 15mm x 30mm OVAL ROD



- Designed to give extra support for longer spans.

PART #	FINISH
S84-3015CS-SB	Satin Brass
S84-3015CS-SC	Satin Chrome
S84-3015CS-ORB	Oil Rubbed Bronze

Screws sold separately. Use #8 x 3/4" Flathead drywall screw, Part # SCR-8750FHZ, sold on page 300.

ALUMINUM ROUND 1-5/16" CLOSET ROD

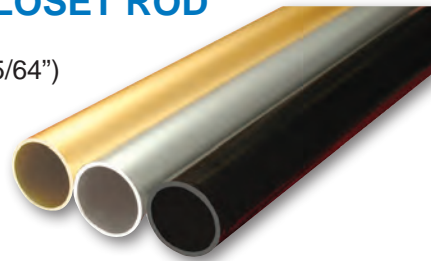

- Eight foot length
- Wall thickness (5/64")

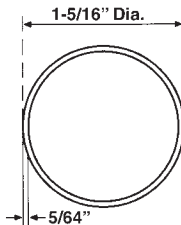

PART #	FINISH
S84-1516-SB	Satin Brass
S84-1516-SC	Satin Chrome
S84-1516-ORB	Oil Rubbed Bronze

ROUND 1-5/16" CLOSET ROD FLANGE with PINS

U-FLANGE

O-FLANGE



- 5mm & 8mm Pins
- 1-9/16" OD Size

PART #	DESCRIPTION	FINISH
S84P-1516U-SB	U-Flange w/Pins	Satin Brass
S84P-1516U-SC		Satin Chrome
S84P-1516U-ORB		Oil Rubbed Bronze
S84P-1516O-SB	O-Flange w/Pins	Satin Brass
S84P-1516O-SC		Satin Chrome
S84P-1516O-ORB		Oil Rubbed Bronze

ROUND CLOSET ROD SUPPORTS FOR 1-5/16" ROUND ROD

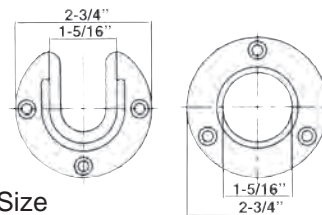

- Screw Mount
- 2-3/4" OD Size

PART #	DESCRIPTION	FINISH
S84-1516U-SB	U-Flange	Satin Brass
S84-1516U-SC		Satin Chrome
S84-1516U-ORB		Oil Rubbed Bronze
S84-1516O-SB	O-Flange	Satin Brass
S84-1516O-SC		Satin Chrome
S84-1516O-ORB		Oil Rubbed Bronze

Screws sold separately. Use #8 x 3/4" Flathead drywall screw, Part # SCR-8750FHZ, sold on page 300.

ROUND CENTER ROD SUPPORTS FOR 1-5/16" ROUND ROD



- Designed to give extra support for longer spans.

PART #	FINISH
S84-1150CS-SB	Satin Brass
S84-1150CS-SC	Satin Chrome
S84-1150CS-ORB	Oil Rubbed Bronze

Screws sold separately. Use #8 x 3/4" Flathead drywall screw, Part # SCR-8750FHZ, sold on page 300.

PRODUCT FEATURES:

- All new patent pending suspension rail makes quick work of any installation.
- The unique hole pattern allows the installer to quickly locate all of the stud locations. Simply find the first stud, identify the hole and there will be a stud every time the pattern repeats.
- All metal brackets - cover sold separately.
- 286 lb. carrying capacity per wall cabinet.
- Left (L) or Right (R) brackets available, **please specify when ordering**

Rail & Bracket Cover Colors:

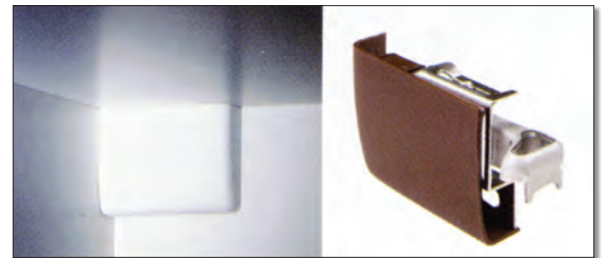
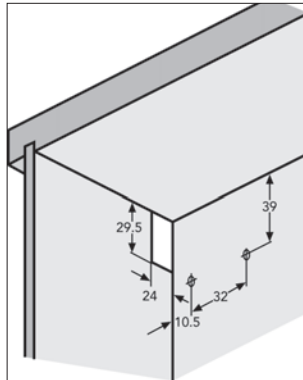

BONUS
Save time with this
unique hole pattern
feature

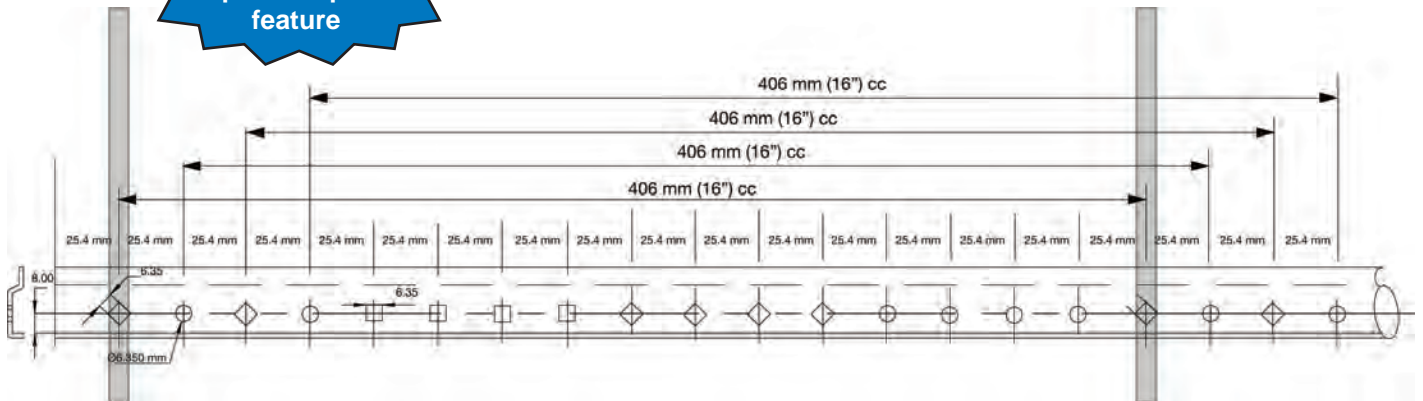

SUSPENSION RAIL & COVERS

PART#	DESCRIPTION	BOX QUANTITY
SUS-R	8' Suspension Rail	10
SUS-C-WH	White Rail Cover	50
SUS-C-AL	Almond Rail Cover	50
SUS-C-BR	Brown Rail Cover	50

SUSPENSION RAIL BRACKETS & COVERS

PART# (SPECIFY LEFT OR RIGHT)	COLOR	BOX QUANTITY
SUS-B-(L or R)	Rail Bracket	200
SUS-BC-WH-(L or R)	Bracket Cover-White	200
SUS-BC-AL-(L or R)	Bracket Cover-Almond	200
SUS-BC-BR-(L or R)	Bracket Cover-Brown	200

"CREATE - A - CLOSET" ...AND MORE!
CLOSET, PANTRY AND GARAGE SOLUTIONS



HEMLOCK CLOSET ROD & END CAPS
1-5/16" Diameter Wood Closet Rod w/Plastic Cover

- 96" Long
- Hemlock Wood
- Seamless, scratch resistant and non-marring polyethylene cover
- Finger jointed; thus no bowing, shrinking or expansion of wood
- Optional end caps available

OPTIONAL END CAPS VG-700-627-*



PART #	DESCRIPTION	CARTON QTY.
VG-700-641C-WH	White Closet Rod	18 pieces
VG-700-641C-AL	Almond Closet Rod	
VG-700-641C-CP	Chocolate Pearwood Closet Rod	
VG-700-627-WH	White End Cap	100 pieces
VG-700-627-AL	Almond End Cap	
VG-700-627-CP	Chocolate Pearwood End Cap	

- 3/4" and 5/8" shelves
- ABS and Polystyrene
- Field trimmable, nominal 14" & 16" lengths
- Effectively joins two shelf panels for corner and straight applications

SHELF JOINER

VG-700-637

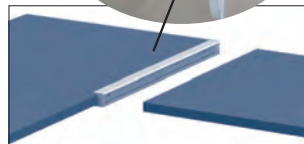
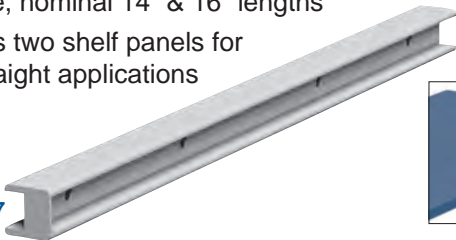

PART #	DESCRIPTION	COLOR	CARTON QTY.
VG-700-637-	3/4" x Nominal 16" Deep	(WH) White	100 pieces
		(CP) Chocolate Pearwood	
VG-700-635-	5/8" x Nominal 16" Deep	(AL) Almond	
		(BR) Cherry Brown	
VG-700-637A-	3/4" x Nominal 14" Deep	(TN) Tan	100 pieces
		(BK) Black	



**AVAILABLE IN
THE FOLLOWING
COLORS**

"CREATE - A - CLOSET"...AND MORE!
CLOSET, PANTRY AND GARAGE SOLUTIONS



SHELF CENTER SUPPORTS



VG-700-634
CROSS HATCHED DESIGN
(Shown in White)



VG-700-634C
CONTEMPORARY DESIGN
(Shown in Chocolate Pearwood)

BACK PLATE
TO CONCEAL
SCREWS

- ABS
- Use with 12", 14" and 16" deep shelves
- Designed to support 150 lbs. when back plate is installed directly into a stud - REQUIRED
- Unique back plate conceals all screws
- Recommended spacing of every 36" to 48", as long as mounted to a stud

PART #	STYLE	COLOR	CARTON QTY.
VG-700-634-	Cross Hatch	(WH) White	20
VG-700-634C-	Contemporary	(CP) Chocolate Pearwood	pieces

SHELF & ROD CENTER SUPPORTS



VG-700-633
CROSS HATCHED DESIGN
(Shown in White)



VG-700-633C
CONTEMPORARY DESIGN
(Shown in Chocolate Pearwood)

BACK PLATE
TO CONCEAL
SCREWS

- ABS
- Use with 1-5/16" wood closet rod
- Use with 12", 14" and 16" deep shelves
- Designed to support 150 lbs. when back plate is installed directly into a stud - REQUIRED
- Unique back plate conceals all screws
- Recommended spacing of every 36" to 48", as long as mounted to a stud

PART #	STYLE	COLOR	CARTON QTY.
VG-700-633-	Cross Hatch	(WH) White	20
VG-700-633C-	Contemporary	(CP) Chocolate Pearwood	pieces

ROD & SHELF SUPPORTS

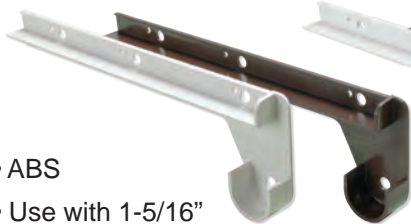

VG-700-630-12



VG-700-630-14



VG-700-630-16



- ABS
- Use with 1-5/16" wood closet rod
- Works with standard 5/8" or 3/4" shelves x 12", 14" & 16" depths
- Designed to support 300 lbs. when installed with anchor & pin system (VG-700-805B), no stud location required

PART #	DESCRIPTION	COLOR	CARTON QTY.
VG-700-630-12-	12" Deep Shelf Supports	(WH) White	25
VG-700-630-14-	14" Deep Shelf Supports	(CP) Chocolate Pearwood	pairs
VG-700-630-16-	16" Deep Shelf Supports		



ANCHOR & PIN SYSTEM

VG-700-805B (WHITE)
CARTON: 500 sets

"CREATE - A - CLOSET" ...AND MORE! CLOSET, PANTRY AND GARAGE SOLUTIONS



SHELF SUPPORT AND FINISHING CAP

- ABS
- Works with standard 5/8" or 3/4" shelves x 12", 14" & 16" depths
- Designed to support 300 lbs. when installed with anchor & pin system (part#: VG-700-805B), no stud location required
- Optional finishing cap is available to provide a professional finish where the melamine or wood shelf meets the wall

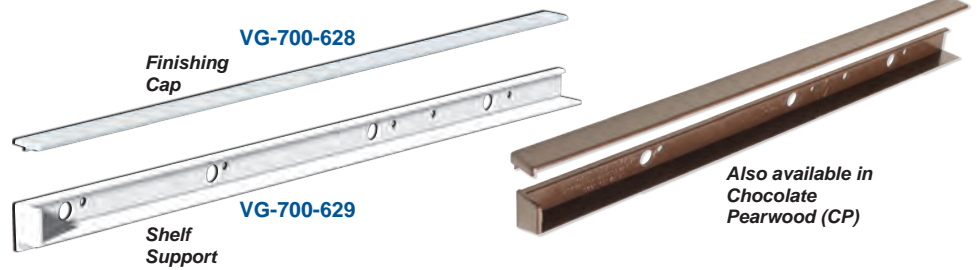

Also available in
Chocolate
Pearwood
(CP)

PART #	DESCRIPTION	SIZE	COLOR	CARTON QTY.
VG-700-629-12-	Shelf Support		(WH) White	50 pairs
VG-700-628A-12-	5/8" Finishing Cap	12"		40 pieces
VG-700-628C-12-	3/4" Finishing Cap		(CP) Chocolate Pearwood	20 pairs
VG-700-629-14-	Shelf Support	14"		50 pairs
VG-700-628-14-	3/4" Finishing Cap		20 pairs	
VG-700-631-16-	Shelf Support		50 pairs	
VG-700-628B-16-	5/8" Finishing Cap	16"	40 pieces	
VG-700-628D-16-	3/4" Finishing Cap		20 pairs	

ANCHOR & PIN SYSTEM

VG-700-805B (WHITE)
CARTON: 500 sets



ECONOMY SHELF SUPPORT



- ABS
- Designed to provide a shelf support for lighter load applications
- Simply install directly into drywall or wood anchors

PART #	DESCRIPTION	COLOR	CARTON QTY.
VG-700-639B-	Economy Shelf Support	(WH) White (CP) Chocolate Pearwood (AL) Almond (BR) Cherry Brown (TN) Tan (BK) Black	250 pieces
VG-700-805B	Anchor & Pin System	White	500 sets



CLOSET ROD SOCKETS

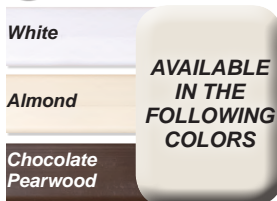

- ABS
- Available with 5mm pegs, (Inquire for sockets without pegs)
- Supports closet rods up to 1-3/8" diameter
- 32mm compatible

PART #	COLOR	CARTON QTY.
VG-140-0116-	(WH) White	100 pairs
	(AL) Almond	
	(CP) Chocolate Pearwood	

INSTALLATION JIG FOR ALL SHELF SUPPORTS

Quick & easy installation with the Vanguard® shelving jig
VG-600-JIG

GARAGE ORGANIZATION

GREAT WALL PVC AND ALUMINUM SLATWALL SYSTEM

New

STANDARD DUTY PANELS

Material: PVC

Lengths: 1' x 4' and 1' x 8'
3" on center

- Panel 11/16" Thick
- 25 Lbs. per Sq. Ft. Load Capacity

PART #	DESCRIPTION
GRW-1X4-WH	1' x 4' White Great Wall Panel
GRW-1X4-BK	1' x 4' Black Great Wall Panel
GRW-1X4-AL	1' x 4' Almond Great Wall Panel
GRW-1X4-MP	1' x 4' Maple Great Wall Panel
GRW-1X8-WH	1' x 8' White Great Wall Panel
GRW-1X8-BK	1' x 8' Black Great Wall Panel
GRW-1X8-AL	1' x 8' Almond Great Wall Panel
GRW-1X8-MP	1' x 8' Maple Great Wall Panel

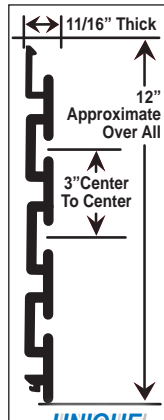

UNIQUE INTERLOCKING DESIGN SECURELY FITS TOGETHER



Mix & MATCH

HERCULES HEAVY DUTY

Material: Aluminum

Length: 6" x 8'
3" on center

- Panel 11/32" Thick
- 300 Lbs. per Sq. Ft. Load Capacity
- Aluminum Slatwall designed to interlock with Standard Duty PVC Slatwall when extra strength is needed.

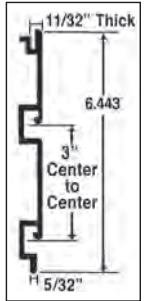

PART #	FINISH
ALU6969-S	Satin
ALU6969-M	Mill

FOR USE WITH ALL ACCESSORIES IN THE SLATWALL HARDWARE SECTION

** Must be ordered in full boxes of 8 pcs. x 4 ft. or 4 pcs. x 8 ft.*

HIGH DENSITY HEAVY DUTY PANELS

Material: PVC

Lengths: 1' x 4' and 1' x 8'
3" on center

- Panel 11/16" Thick
- 100 Lbs. per Sq. Ft. Load Capacity

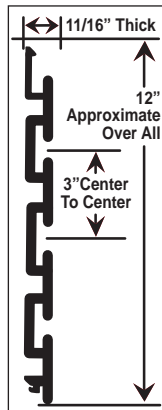

PART #	DESCRIPTION
GRW-HD1X4-WH	1' x 4' White Great Wall Panel
GRW-HD1X4-BK	1' x 4' Black Great Wall Panel
GRW-HD1X4-AL	1' x 4' Almond Great Wall Panel
GRW-HD1X4-MP	1' x 4' Maple Great Wall Panel
GRW-HD1X8-WH	1' x 8' White Great Wall Panel
GRW-HD1X8-BK	1' x 8' Black Great Wall Panel
GRW-HD1X8-AL	1' x 8' Almond Great Wall Panel
GRW-HD1X8-MP	1' x 8' Maple Great Wall Panel

** Must be ordered in full boxes of 8 pcs. x 4 ft. or 4 pcs. x 8 ft.*

COLORMATCH MOULDINGS

Material: PVC

See Pgs. 383-387 For Garage Hardware



PART #	DESCRIPTION
GRW-JNR8-WH	8' White Joint Trim For Great Wall
GRW-JNR8-BK	8' Black Joint Trim For Great Wall
GRW-JNR8-AL	8' Almond Joint Trim For Great Wall
GRW-JNR8-MP	8' Maple Joint Trim For Great Wall
GRW-END8-WH	8' White End Cap For Great Wall
GRW-END8-BK	8' Black End Cap For Great Wall
GRW-END8-AL	8' Almond End Cap For Great Wall
GRW-END8-MP	8' Maple End Cap For Great Wall

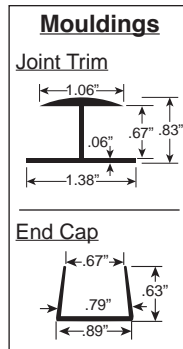

COLOR MATCH SCREWS

Material: Steel

PART #	DESCRIPTION
GRW-2500SCR-WH	2-1/2"-L White Screw For Great Wall
GRW-2500SCR-BK	2-1/2"-L Black Screw For Great Wall
GRW-2500SCR-AL	2-1/2"-L Almond Screw For Great Wall
GRW-2500SCR-MP	2-1/2"-L Maple Screw For Great Wall

** Screws packed 100 pcs. per box - no Broken Boxes*

GARAGE ORGANIZATION

STANDARD DUTY HOOKS

All Accessories You Need To Get Organized!



PART #	DESCRIPTION	CTN QTY
GRD-PSD-2BK	Black 2" Plastic Slatwall Hook	12
GRD-PSD-2FG	Fog Gray 2" Plastic Slatwall Hook	12
GRD-PSD-2WH	White 2" Plastic Slatwall Hook	12
GRD-PSD-4BK	Black 4" Plastic Slatwall Hook	12
GRD-PSD-4FG	Fog Gray 4" Plastic Slatwall Hook	12
GRD-PSD-4WH	White 4" Plastic Slatwall Hook	12

PART #	DESCRIPTION	CTN QTY
GRD-SD-1BC	Brite Chrome 1" Metal Slatwall Hook	12
GRD-SD-4BC	Brite Chrome 4" Metal Slatwall Hook	12



PART #	DESCRIPTION	CTN QTY
GRD-SD-HF	Brite Chrome Flush Metal Slatwall Hook	12

PART #	DESCRIPTION	CTN QTY
GRD-H5-BC	Brite Chrome 5 Hook Metal Bracket	3
GRD-H5-BK	Black 5 Hook Metal Bracket	3
GRD-H5-WH	White 5 Hook Metal Bracket	3

** Not Recommended For Use On Standard Duty Great Wall.*



PART #	DESCRIPTION	CTN QTY
GRD-KB-8BC	Brite Chrome 8" Metal Knife Bracket	6
GRD-KB-8BK	Black 8" Metal Knife Bracket	6
GRD-KB-8WH	White 8" Metal Knife Bracket	6
GRD-KB-10BC	Brite Chrome 10" Metal Knife Bracket	6
GRD-KB-10BK	Black 10" Metal Knife Bracket	6
GRD-KB-10WH	White 10" Metal Knife Bracket	6
GRD-KB-12BC	Brite Chrome 12" Metal Knife Bracket	6
GRD-KB-12BK	Black 12" Metal Knife Bracket	6
GRD-KB-12WH	White 12" Metal Knife Bracket	6

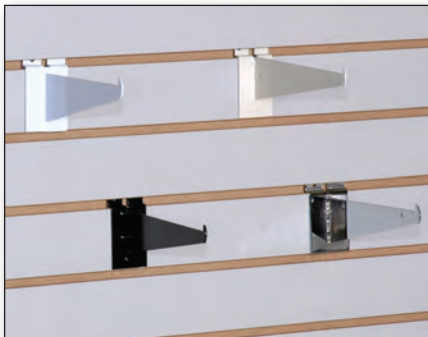

PART #	DESCRIPTION	CTN QTY
GRD-EA-S	Support Arm For Metal Knife Bracket	4



IT'S A SNAP WITH SUPER HOOKS

All Accessories You Need To Get Organized!

PRODUCT FEATURES:

- Strong & durable with positive locking action.
- Works with most 3" on center slatwall.
- Charcoal gray with pvc coating.



Part #- GRD-H4L-BK

Description- Charcoal 10" Metal Hook Loop
With PVC Coating
CTN QTY- 6



Part #- GRD-H4SD-BK

Description- Charcoal 4" Metal Double
Hook With PVC Coating
CTN QTY- 6



Part #- GRD-H8SD-BK

Description- Charcoal 8" Metal Double
Hook With PVC Coating
CTN QTY- 6

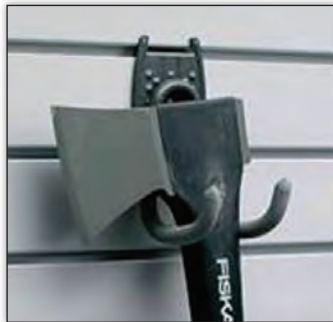

Part #- GRD-J6-BK

Description- Charcoal Large Metal "J"
Hook With PVC Coating
CTN QTY- 6



Part #- GRD-SHK-BK

Description- Charcoal Metal "S" Hook
With PVC Coating
CTN QTY- 6



Part #- GRD-J-BK

Description- Charcoal Small Metal "J" Hook
With PVC Coating
CTN QTY- 6

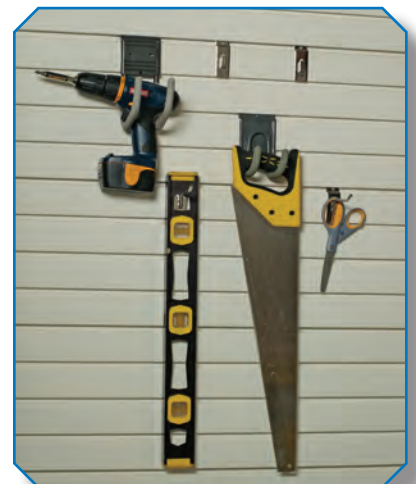

SPECIALTY HOOKS & RACKS

All Accessories You Need To Get Organized!

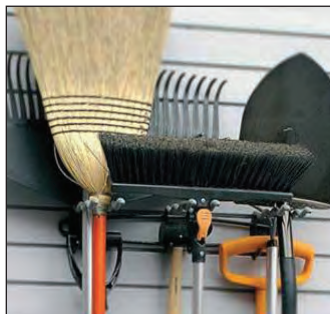

Part #- GRD-TB-BK

Description- Charcoal Metal Long Tool Bar
With PVC Coating
CTN QTY- 4



Part #- GRD-GDN-BK

Description- Charcoal Metal Garden
Rack With Basket
CTN QTY- 6



Does not work with EZ Slatwall

Part #- GRD-SPRP-TN

Description- Tan Plastic Sports Rack
(Needs Mounting Clips)
CTN QTY- 1



Part #- GRD-5BH-BK

Description- Charcoal 5" Metal Bike Hook
With PVC Coating
CTN QTY- 6



Part #- GRD-SPOR-BK

Description- Charcoal Metal Sports
Accessory Rack
CTN QTY- 4

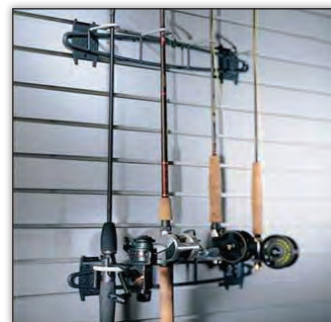

Part #- GRD-FHH-BK

Description- Charcoal Metal Fishing Rod Holder
With Rubberized Grip (Holds 4 Fishing Rods)
CTN QTY- 4



Part #- GRD-HBKR-BK

Description- Charcoal Metal Horizontal
Bike Rack
CTN QTY- 4



Part #- GRD-SKR-BK

Description- Charcoal Metal Ski Rack
CTN QTY- 6

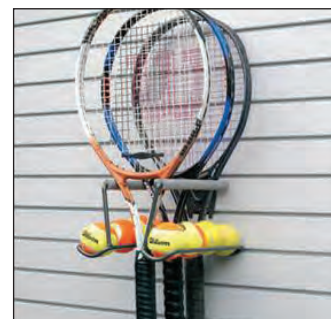

Part #- GRD-TNH-BK

Description- Charcoal Metal Tennis
Accessory Holder With Rubberized Sleeve
CTN QTY- 4

SPECIALTY HOOKS, SUPER BASKETS, & SUPER SHELF

All Accessories You Need To Get Organized!



Part #- GRD-GLF-BK

Description- Charcoal Golf Accessory Rack With Basket

CTN QTY- 4



Does not work with EZ Slatwall

Part #- GRD-HHD-TN

Description- Tan Plastic Garden Hose Holder (Holds Up To 150' Of Hose & Needs Mounting Clips)

CTN QTY- 4



Part #- GRD-SKTR-BK

Description- Metal Skate Rack With Basket

CTN QTY- 4



Part #- GRD-TOOL-BK

Description- Charcoal Metal Tool Rack

CTN QTY- 4



Part #- GRD-24TL-BK

Description- Black 24" Magnetic Tool Bar (Needs Mounting Clips)

CTN QTY- 1

Does not work with EZ Slatwall

Part #- GRD-13TL-BK

Description- Black 13" Magnetic Tool Bar (Needs Mounting Clips)

CTN QTY- 1



Part #- GRD-B16114-BK

Description- Small Metal Basket
16" x 11-1/2" x 4"

CTN QTY- 4



Part #- GRD-B16118-BK

Description- Large Metal Basket
16" x 11-1/2" x 8"

CTN QTY- 4



Part #- GRD-S2007-BK

Description- Charcoal 20" X 7" Shelf
With 2 Hooks

CTN QTY- 4

GARAGE ORGANIZATION

K RESIN & CRYSTAL STYRENE SUPER BINS

All Accessories You Need To Get Organized!



Does not work with EZ Slatwall

Part #- GRD-MT-BK
Description- Black Mounting Clip-- Set of 2
CTN QTY- 25

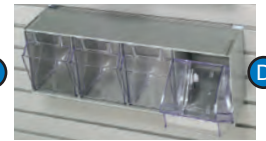

Does not work with EZ Slatwall

	PART #	DESCRIPTION	CTN QTY
* A	GRD-9TLT-TN	Plastic Tan 9 Tilt Bin Storage Unit 23 1/2"-W x 3"-H x 2"-D	12
* B	GRD-6TLT-TN	Plastic Tan 6 Tilt Bin Storage Unit 23 1/2"-W x 4 1/2"-H x 3"-D	12
* C	GRD-5TLT-TN	Plastic Tan 5 Tilt Bin Storage Unit 23 1/2"-W x 6 1/2"-H x 4 1/2"-D	6
* D	GRD-4TLT-TN	Plastic Tan 4 Tilt Bin Storage Unit 23 1/2"-W x 8"-H x 5 1/2"-D	6

METAL UTILITY BASKETS

WORKS WITH E-Z SLATWALL & GREAT WALL



12" x 6" x 6"
GRD-U1266-BK...(Black)
GRD-U1266-WH...(White)
Carton Quantity: 6



12" x 12" x 4"
GRD-U12124-BK...(Black)
GRD-U12124-WH...(White)
Carton Quantity: 6

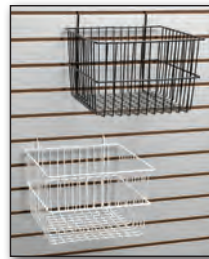

12" x 12" x 8"
GRD-U12128-BK...(Black)
GRD-U12128-WH...(White)
Carton Quantity: 6



24" x 12" x 4"
GRD-U12244-BK...(Black)
GRD-U12244-WH...(White)
Carton Quantity: 6

ALUMINUM "NO BOW" SHELF CHANNEL



For 1/2", 5/8", & 3/4" Shelves
8 Ft. Lengths

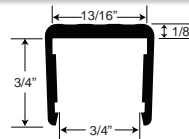
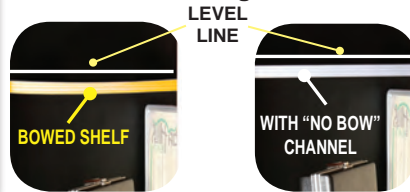

- Clear Anodized *(S)
- Black Powder Coat *(BK)
- White Powder Coat *(W)

PART #	SHELF WIDTH
SHF-A500*	1/2"
SHF-A625*	5/8"
SHF-A750*	3/4"

ALUMINUM SHELF SUPPORT BRACKET

ALUMINUM SLATWALL SHELF BRACKET

AVAILABLE IN 1', 2', 4' OR 8' LENGTHS⁰
Made of Clear Anodized Aluminum



- EASY AS:
- 1 - PICK SHELF LENGTH
 - 2 - INSERT SHELF INTO EXTRUSION
 - 3 - HANG ON SLATWALL

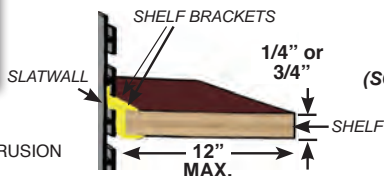

HOLDS UP TO
12" D SHELF x 1/4"
OR 3/4" THICK
(SCREWS INCLUDED FOR
3/4" THICK ONLY)

	PART #	LENGTH
1/4" THICK SHELF	51790-1	1'
	51790-2	2'
	51790-4	4'

	PART #	LENGTH
3/4" THICK SHELF	41790-1	1'
	41790-2	2'
	41790-4	4'
	41790-8	8'

⁰THE LENGTH OF THE BRACKET IS 1/4" LESS THAN THE SUGGESTED SHELF LENGTH