

2014



MILLWORK - INTERIOR

MILLWORK: INTERIOR

Pgs. 777-865

ORAC DECOR
COLLECTION

FOCAL POINT
designer's
edge MILLWORK

Ceiling Domes



Ceiling Medallions



Niches



Corbels

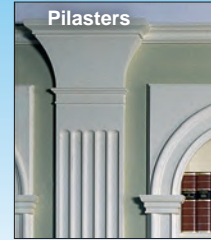

Pilasters

Columns

Cornice Mouldings

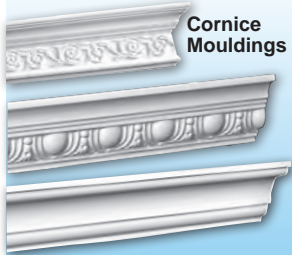

Door Surrounds & Accessories



Panel Mouldings

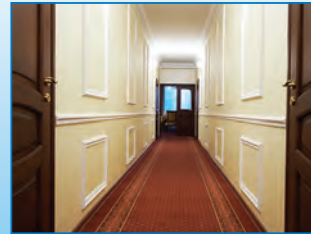

Library Facade System



ADHESIVES

Duropolimer® CX/PX/ SX (FDP-500)	777
Orac®	849
Polystyrene LD (EPS-ADH)	850
Polystyrene RPS (MP-25-ADH)	777, 795
Polyurethane DEM (ADH1)	777, 796

BASE MOULDINGS

DEM	808
-----	-----

BASE MOULDINGS ACCESSORIES

<i>Inside/Outside Corners</i>	
DEM	808

CASE MOULDINGS

DEM	807
-----	-----

CEILING DOMES

<i>Fiberglass</i>	
Recessed w/Elliptical Plain Cove	773
Recessed w/Light Cove	773
Recessed w/Optional Trim	773
Recessed w/Round Bow & Swag Cove	773
Recessed w/Round Plain Cove	773
Recessed	772

High Density Polyurethane

Recessed	770-771, 774
Surface Mount	771, 774

CEILING MEDALLIONS

DEM	809-812
Focal Point	854
Orac®	841-844

COLUMNS

<i>Classical Half Columns</i>	
Orac®	836
<i>Classical Whole Columns</i>	
Orac®	838
<i>Contemporary Half Columns</i>	
Orac®	835
<i>Contemporary Whole Columns</i>	
Orac®	837

COMMON MOULDINGS

DEM	806
-----	-----

CORBELS

DEM	787
Orac®	848

CORNICE MOULDINGS

<i>Combination Mouldings</i>	
DEM	793
<i>Cornice Mouldings for Indirect Lighting</i>	
DEM	791
Orac®	824

Cornice Mouldings

DEM	779-786
Orac®	822-826

Flexible Cornice Mouldings

Orac®	832
-------	-----

Large Decorative Cornice Mouldings

DEM	787
-----	-----

Large Plain Cornice Mouldings

DEM	792
-----	-----

Plain Cornice Mouldings

DEM	788-791
-----	---------

CORNICE MOULDINGS ACCESSORIES

<i>Corbels</i>	
DEM	787
Orac®	848
<i>Corners (Decorative, Inside, Outside)</i>	
DEM	780-785, 792, 794

Large Decorative Drops

DEM	796
-----	-----

CROWN MOULDINGS

Focal Point	852
Low Density Extruded Polystyrene	850

DOOR CASINGS

DEM	814
-----	-----

DOOR SURROUNDS & ACCESSORIES

DEM	817-818
Orac®	846

FIRE SURROUNDS

Classic Wood	863-865
Hand Carved Solid Maple	860-862

FIREPLACE SURROUNDS

Orac®	847
-------	-----

FRIEZES

DEM	799
Focal Point	853

LIBRARY FACADE SYSTEM

Orac®	840
-------	-----

MANTEL COLUMNS

Full Round Columns	859
Half Round Columns	859

MANTEL HEADERS

Orac®	865
-------	-----

MANTEL LEGS

Orac®	849
-------	-----

MITER BOXES (Fixed & Adjustable) & SAW KIT

Orac®	849
-------	-----

MOULDINGS

Flexible "Made To Fit" Mouldings	857-858
----------------------------------	---------

NICHE SHELL CAPS

Focal Point	856
-------------	-----

NICHES

Recessed

DEM	819
Focal Point	855-856

Orac®

	831
--	-----

Surface Mounted

DEM	819
-----	-----

Focal Point

	855-856
--	---------

PANEL MOULDINGS

Decorative Panel Mouldings

DEM	797-799
Orac®	828, 830

Flexible Panel Mouldings

Orac®	832
-------	-----

Plain Panel Mouldings

DEM	800
Orac®	827, 830

PANEL MOULDINGS ACCESSORIES

Butt Joint Corners

DEM	802-805
-----	---------

Mitreless Covers

DEM	802-805
-----	---------

Pediments

Orac®	845
-------	-----

PILASTERS

Massive

DEM	816
-----	-----

Standard

DEM	815
-----	-----

Orac®

	833-834
--	---------

RAISED PANELS

Orac®	847
-------	-----

SHELVES

Orac®	845
-------	-----

STAIR BRACKETS

DEM	812
-----	-----

Focal Point

	853
--	-----

TRIM-FAST™ (The Miter-Free Corbel System)

	795
--	-----

WALL DECORATIONS

Orac®	845
-------	-----

WALL LIGHT SCONCES

Orac®	848
-------	-----

WINDOW CASINGS

DEM	814
-----	-----

SEE PAGES 1007-1023 FOR A - Z INDEX

3 Distinctive Mouldings

Value and Design come together to create a line of millwork designed to give all your projects a distinctive finish... a designers finish.



designer's
edge MILLWORK

Polystyrene High Density RPS Mouldings

RPS 100% Recycled High Density Mouldings, which are impervious to adverse climate and weather conditions, offer an economical decorative and design medium that are manufactured from renewable polystyrene resources. Introduced as a cost effective alternative to more costly polymer mouldings and millwork, RPS Mouldings will aesthetically satisfy all decorative requirements without having to compromise for lesser quality mouldings. The polystyrene compound from which RPS Mouldings are manufactured, not only produces a durable, impact resistant surface, making them ideally suited for use in highly trafficked environments, RPS Mouldings can be easily cut, nailed, glued, finished and installed using the same woodworking techniques and tools as wood and mdf mouldings & millwork.

The "Original" Hybrid Formula

MP-25-ADH is a high performance, one component, permanently flexible, easy to use, multi-purpose fast cure modified polyurethane sealant. MP-25-ADH cures rapidly when exposed to atmospheric moisture to form a durable bond.

- Use as adhesive or filler
- Eco-friendly, low VOC's
- Fast cure • Paintable • Non-yellowing

MP-25-ADH



designer's
edge MILLWORK

Polyurethane DEM Mouldings

DEM Mouldings and Millwork encompass a full decorative array of premium quality polyurethane cornice and panel mouldings, medallions, niches, stair brackets, pilasters and other ornamental products that are guaranteed to satisfy all decorative requirements without compromise. DEM is impervious to adverse climate and weather conditions, and, because of its dimensional stability, will not alter over time. Produced in exclusive molds that yield ornate and sharply defined details, perfect dimensions, and extremely consistent quality, DEM is lightweight, impact resistant and easy to install and finish using traditional woodworking techniques and tools.

ADH1 10.6 oz tube
PL Premium Adhesive
Approximate adhesive yields*
Mouldings 2" + Under – 60'
Mouldings 2 - 5" – 45'
Mouldings 5" + Over – 30'
** Yields are approximate and based on average conditions and installation technique.*



ORACDECOR
The Art of Decorating

The AXXENT Collection

Duopolymer® CX/PX/SX Mouldings

Discover new atmospheres and styles with high quality interior products. Lightweight, easy to install, easy to paint.

Duopolymer®: The Advanced Polystyrene Composite Blend from which Duopolymer® Mouldings are manufactured, not only produces an extremely durable, impact resistant surface, making Duopolymer® Mouldings ideally suited for use in highly trafficked environments. They can be easily cut, nailed, glued, finished and installed using the same woodworking techniques and tools as wood and mdf mouldings & millwork. Duopolymer® Mouldings, which are impervious to adverse climate and weather conditions, comprise an environmentally friendly, ecologically responsible water based primer coat that is produced without the use of any solvents. In addition, Duopolymer® Mouldings have sharply defined details, perfect dimensions, and extremely consistent quality, enabling them to endure years of repeated refinishing.

Duopolymer® Adhesive FDP-500

310ml cartridge (10-1/2 oz.)





designer's edge MILLWORK

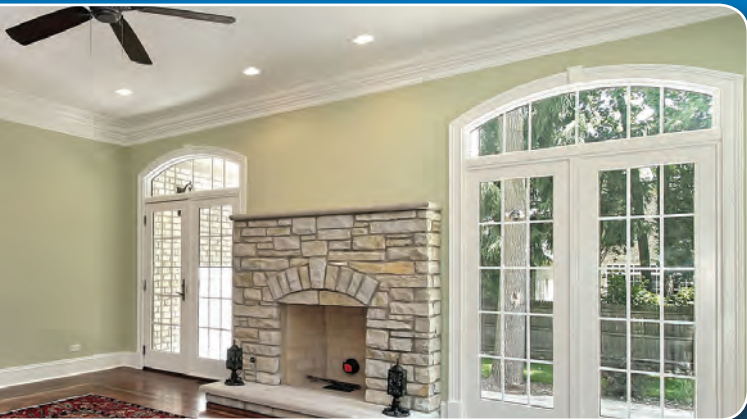
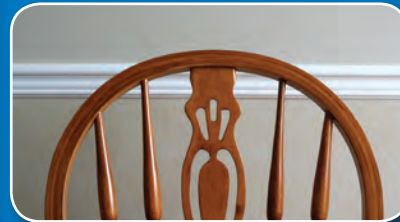
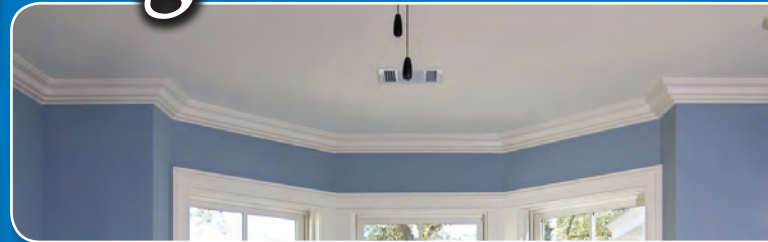

DECORATIVE CORNICES

designer's
edge MILLWORK

Polyurethane DEM Mouldings
Polystyrene RPS Mouldings
Duropolymer® CX Mouldings

100% RECYCLED POLYSTYRENE

DEM-105

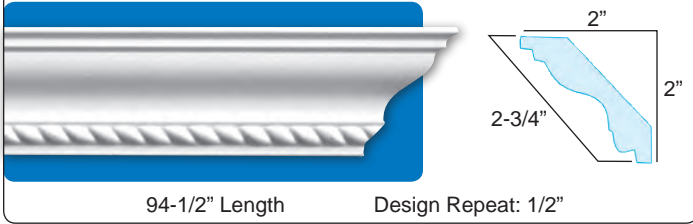

DEM-107

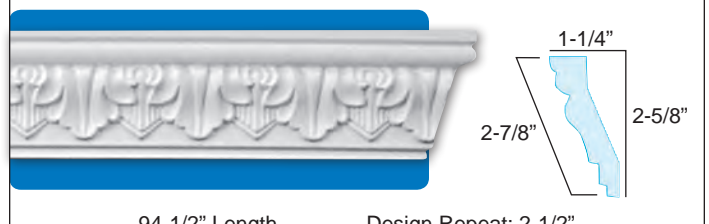

DEM-111

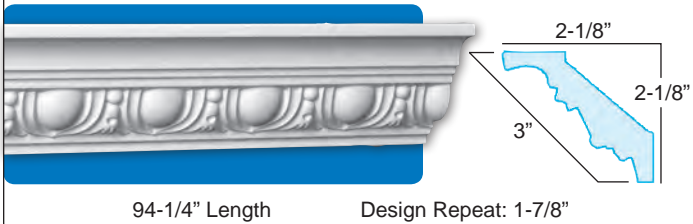

DEM-113

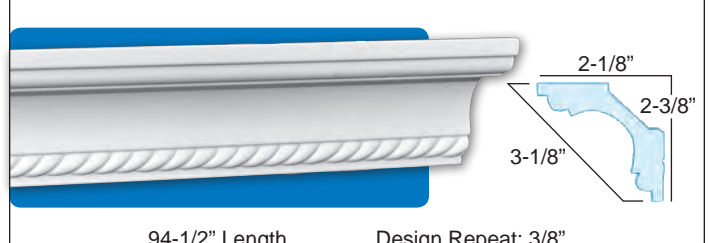

DEM-114

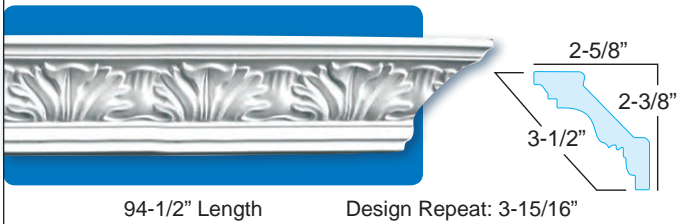

DEM-115

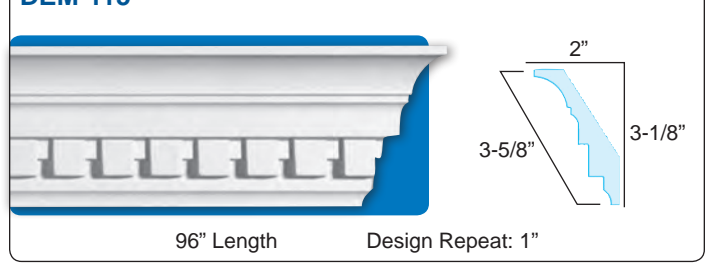

DEM-116

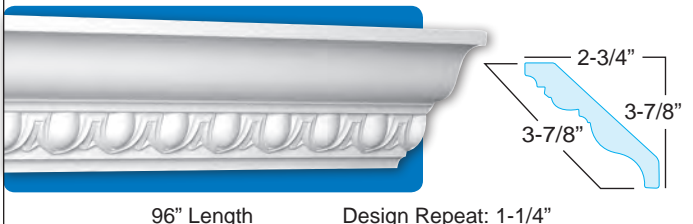

CX101

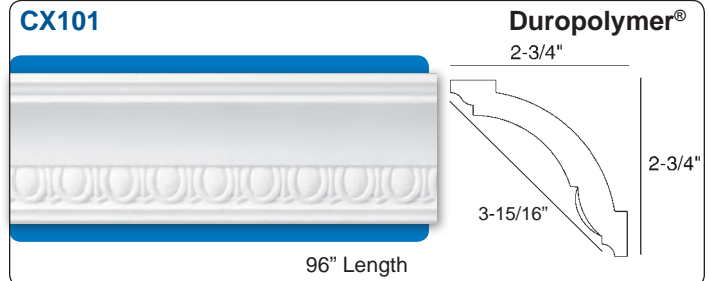

Duropolymer®

CX135

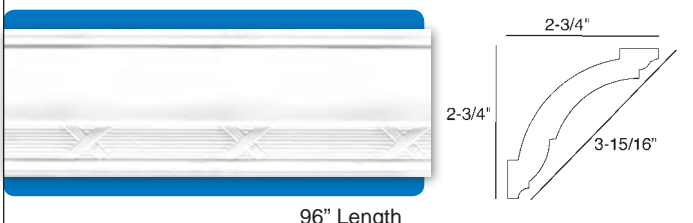

Duropolymer®

CX136

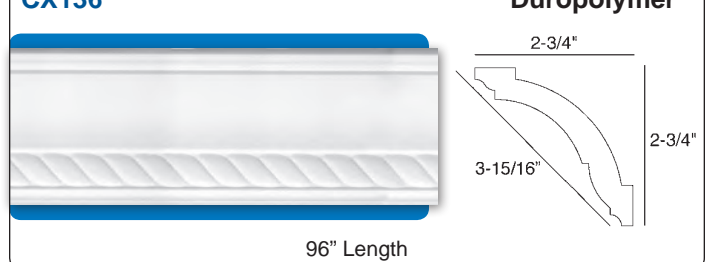

Duropolymer®

DUROPOLYMER® ● HIGH IMPACT
● Recommended blade 10" Blade, 200 Teeth
product information can be found on page 777

All dimensions are approximate.

DECORATIVE CORNICES

designer's
edge MILLWORK

Polyurethane DEM Mouldings
Polystyrene RPS Mouldings

100% RECYCLED POLYSTYRENE

DEM-120

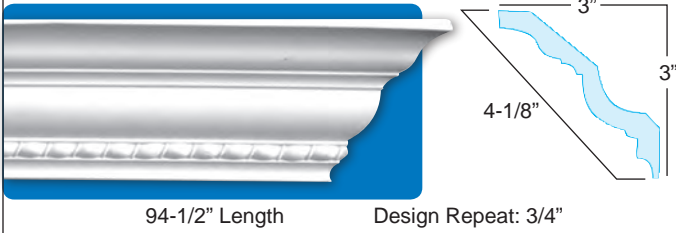

RPS-1120

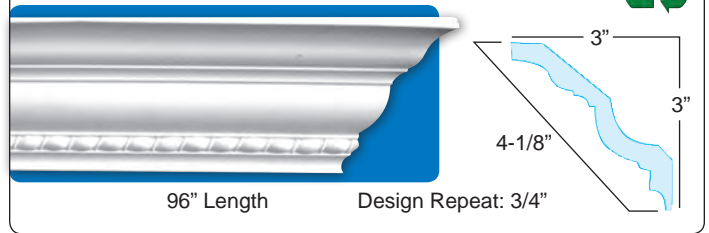

CORNERS

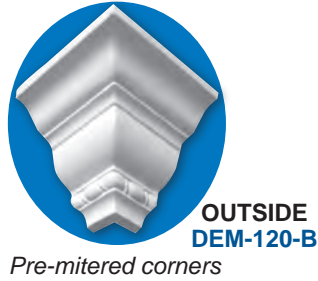
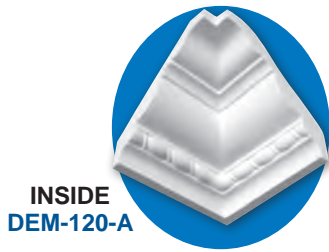

DEM-121

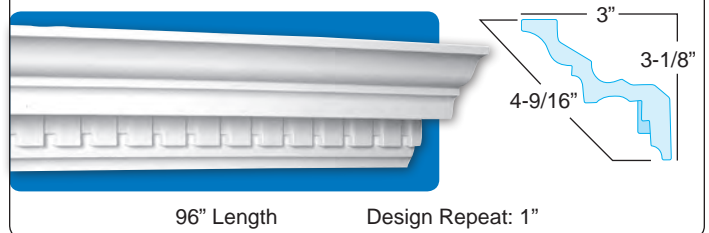

DEM-122

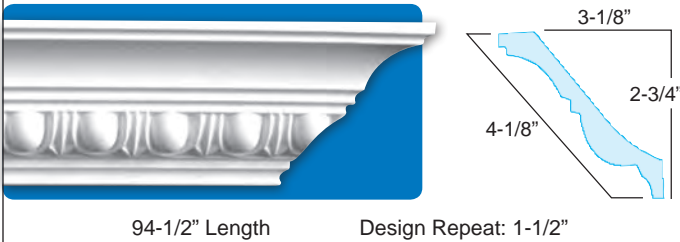

CORNERS



DEM-125



RPS • HIGH IMPACT
• Recommended blade 10" Blade, 200 Teeth
RPS PRODUCT information can be found on page 777

All dimensions are approximate.

DECORATIVE CORNICES

designer's
edge MILLWORK

Polyurethane DEM Mouldings
Polystyrene RPS Mouldings

100% RECYCLED POLYSTYRENE

DEM-126



94-1/2" Length

Design Repeat: 1"

DEM-130



94-1/2" Length

Design Repeat: 4-1/2"

DEM-131



94-1/2" Length

Design Repeat: 7" Corbel to Corbel

CORNERS



INSIDE
DEM-130-A



OUTSIDE
DEM-130-B

Pre-mitered corners

DEM-132



94-1/2" Length

Design Repeat: 31-1/2"

DEM-136



94-1/2" Length

Design Repeat: 1-1/2"

CORNERS



INSIDE
DEM-136-A



OUTSIDE
DEM-136-B

Pre-mitered corners

DEM-134



94-1/2" Length

Design Repeat: 8"

All dimensions are approximate.

DECORATIVE CORNICES

designer's
edge MILLWORK

Polyurethane DEM Mouldings
Polystyrene RPS Mouldings
Duropolymer® CX Mouldings

100% RECYCLED POLYSTYRENE

CX128 Duropolymer®

96" Length

CX129 Duropolymer®

96" Length

DEM-142

94-1/2" Length Design Repeat: 12"

CORNERS

INSIDE DEM-142-A

OUTSIDE DEM-142-B

Pre-mitered corners

DEM-146

94-1/2" Length Design Repeat: 4-1/2"

CORNERS

INSIDE DEM-146-A

OUTSIDE DEM-146-B

Pre-mitered corners

DEM-147

94-1/2" Length Design Repeat: 3-1/2"
(Dot Repeat: 3/8" wide x 3 dots per inch)

DEM-148

94-1/2" Length Design Repeat: 1-5/8"

DEM-149

96" Length Design Repeat: 6"



All dimensions are approximate.

DUROPOLYMER® • HIGH IMPACT
• Recommended blade 10" Blade, 200 Teeth
product information can be found on page 777

DECORATIVE CORNICES

designer's
edge MILLWORK

Polyurethane DEM Mouldings
Polystyrene RPS Mouldings

100% RECYCLED POLYSTYRENE

DEM-150

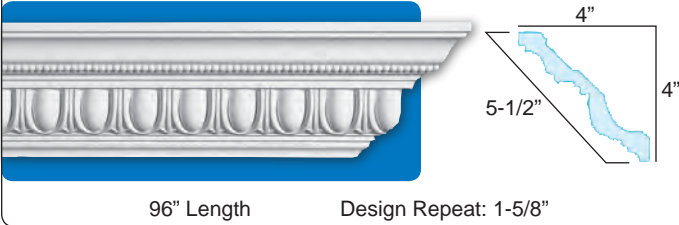

DEM-153

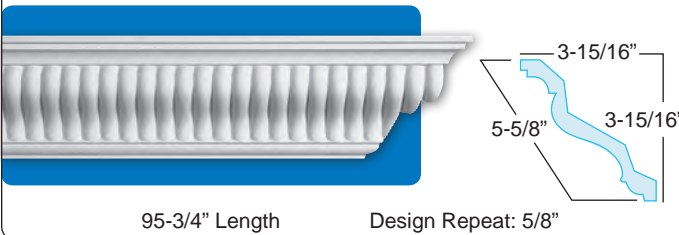

DEM-155

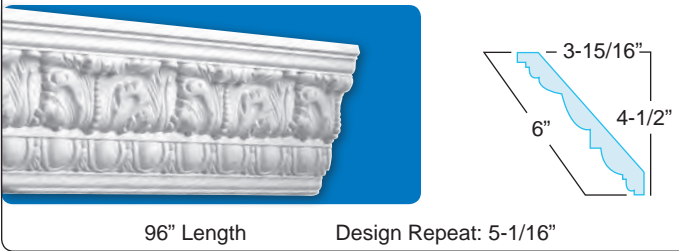

DEM-156

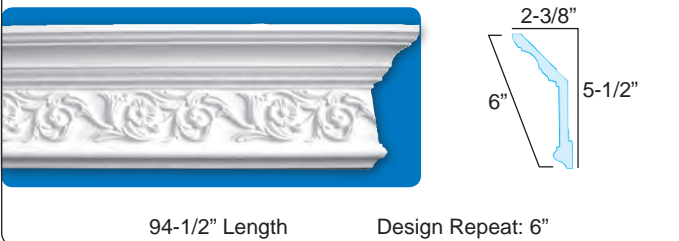

DEM-157

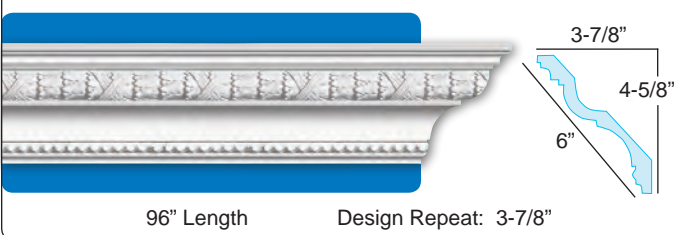

DEM-151

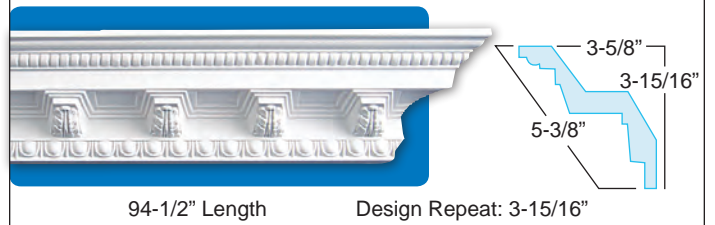

CORNERS

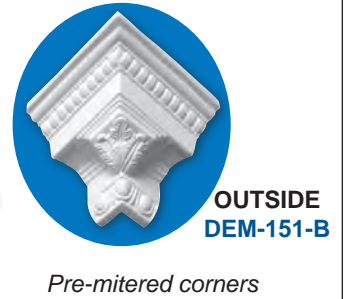

All dimensions are approximate.

DECORATIVE CORNICES

designer's
edge MILLWORK

Polyurethane DEM Mouldings
Polystyrene RPS Mouldings
Duropolymer® CX Mouldings

100% RECYCLED POLYSTYRENE

DEM-158

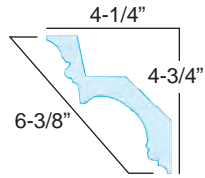

94-1/2" Length

Design Repeat: 3"

DEM-159

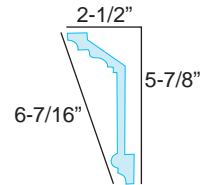

96" Length

Design Repeat: 12"

DEM-160

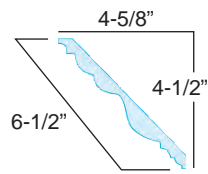

94-1/2" Length

Design Repeat: 19"

DEM-161

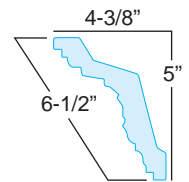

96" Length

Design Repeat: 3-3/8"

DEM-162

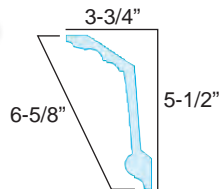

94-1/2" Length

Design Repeat: 11-3/4"

CORNERS

INSIDE
DEM-162-A



OUTSIDE
DEM-162-B



Pre-mitered corners

CX107



Duropolymer®

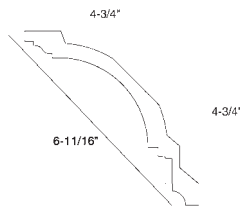

96" Length

DEM-169

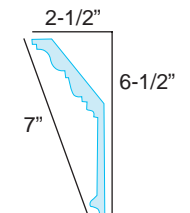

96" Length

Design Repeat: 3-3/4"

DUROPOLYMER® ● HIGH IMPACT
● Recommended blade 10" Blade, 200 Teeth
product information can be found on page 777

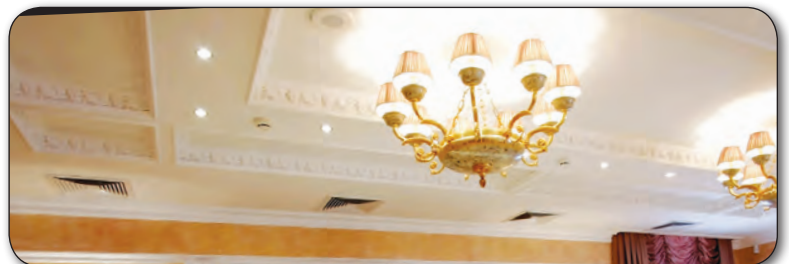

All dimensions are approximate.

DECORATIVE CORNICES

designer's
edge MILLWORK

Polyurethane DEM Mouldings
Polystyrene RPS Mouldings

100% RECYCLED POLYSTYRENE

DEM-170



94-1/2" Length

Design Repeat: 2"

DEM-171



96" Length

Design Repeat: 1-1/4"

DEM-172



94-1/2" Length

Design Repeat: 2"

DEM-174



94-1/2" Length
Design Repeat: 6"

DEM-175



96" Length
Design Repeat: 9-1/2"

CORNERS

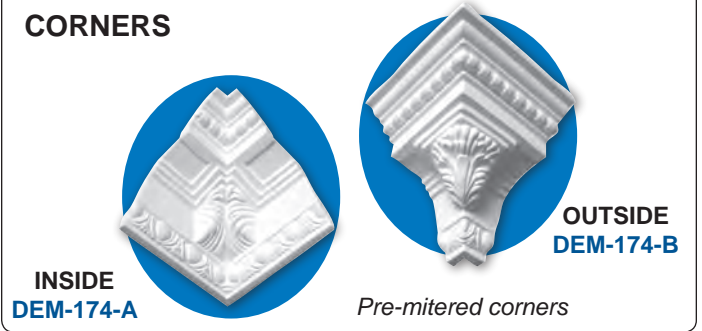

INSIDE
DEM-174-A

OUTSIDE
DEM-174-B

Pre-mitered corners



DEM-177



94-1/2" Length

Design Repeat: 11-1/2"

All dimensions are approximate.

DECORATIVE CORNICES

designer's
edge MILLWORK

Polyurethane DEM Mouldings
Polystyrene RPS Mouldings

100% RECYCLED POLYSTYRENE

DEM-178

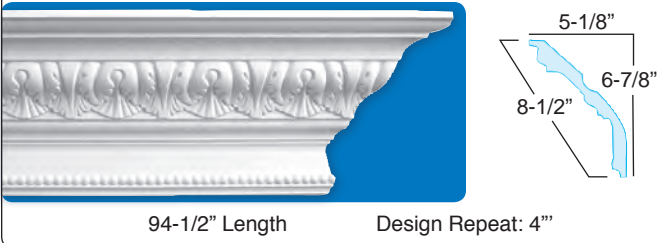

DEM-179

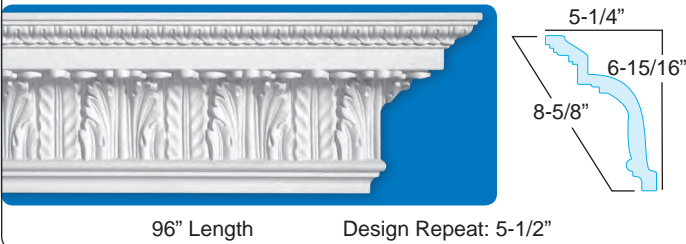

DEM-180

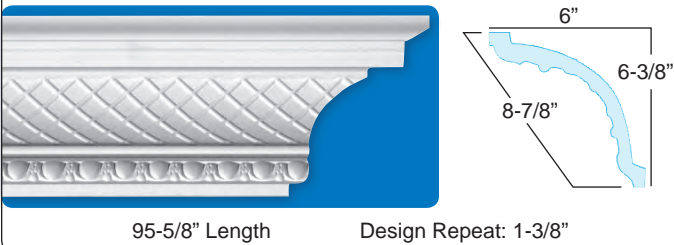

DEM-182

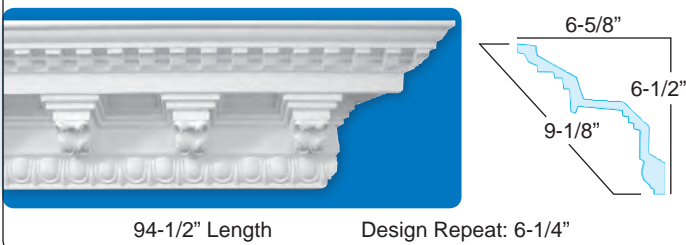

DEM-183

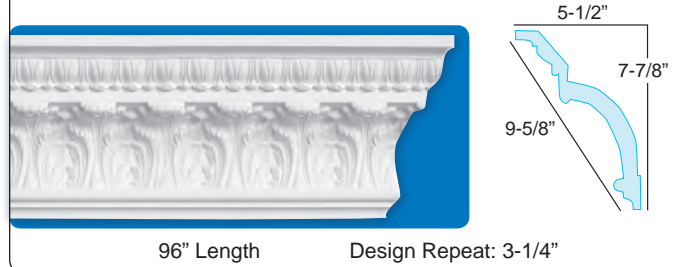

DEM-184

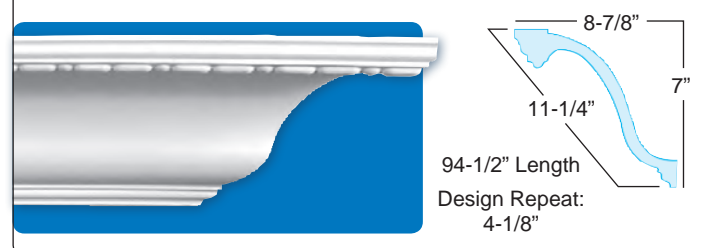

All dimensions are approximate.

LARGE DECORATIVE CORNICES

designer's
edge MILLWORK

Polyurethane DEM Mouldings
Polystyrene RPS Mouldings

100% RECYCLED POLYSTYRENE

DEM-185



95-1/2" Length
Design Repeat:
9-5/8"

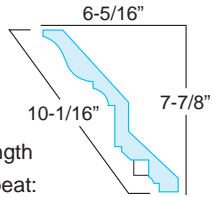

DEM-186



94-1/2" Length
Design Repeat:
7-7/8"

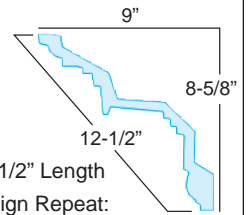

DEM-188



96" Length
Design Repeat: 14"

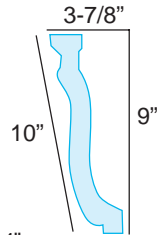

DEM-189

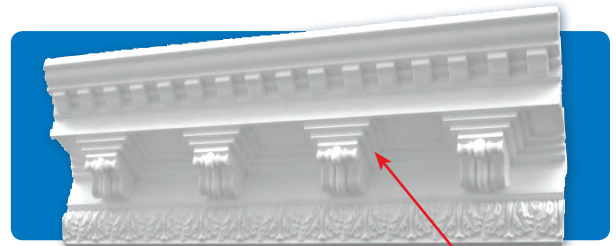

96" Length
Design Repeat: 9-1/2"

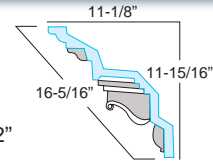

with
attached
corbel

DEM-190

MOULDING
WITHOUT
CORBEL



96" Length
Design Repeat:
9-1/2"

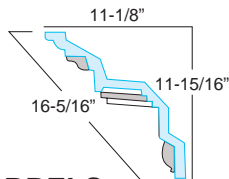

DEM-190A



3-7/8" x
2-13/16" x
2-3/4"

CORBELS

CAN ACCOMMODATE
10 CORBELS

Corbels are
easily applied
with our adhesive
ADH1
10.6 oz tube

DEM-190B



4" x
2-3/4" x
2-5/8"



All dimensions are approximate.

PLAIN CORNICES

designer's
edge MILLWORK

Polyurethane DEM Mouldings
Polystyrene RPS Mouldings
Duropolymer® CX Mouldings

100% RECYCLED POLYSTYRENE

RPS-0201 (8 Ft.)
RPS-0201-12 (12 Ft.)



96" Length

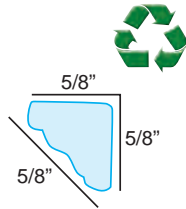

CX111



96" Length

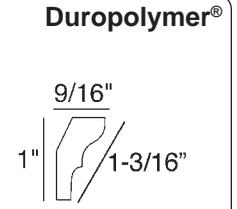

Duropolymer®

CX132



96" Length

Duropolymer®

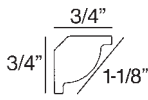

BED MOULDING
RPS-0075



Matches WM75
96" Length

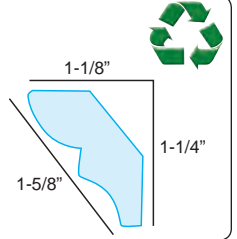

CX115



96" Length

Duropolymer®

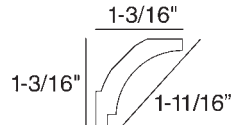

BED MOULDING
RPS-0074 (8 Ft.)
RPS-0074-12 (12 Ft.)



Matches WM74

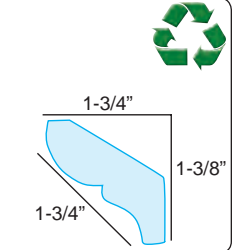

RPS-0283 (8 Ft.)
RPS-0283-12 (12 Ft.)



96" Length

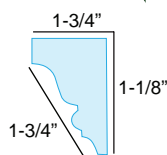

RPS-0284



96" Length

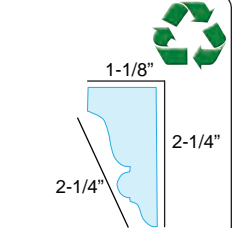

RPS & DUROPOLYMER®
 • HIGH IMPACT
 • Recommended blade 10" Blade, 200 Teeth
 information can be found on page 777

CX110

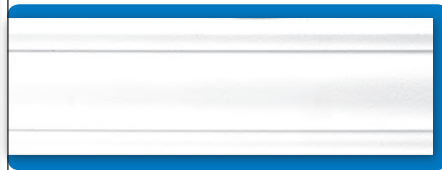

96" Length

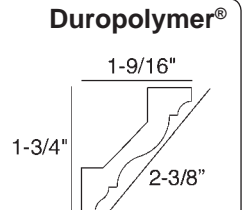

Duropolymer®

CX109



96" Length

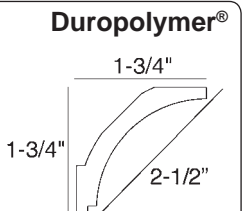

Duropolymer®

All dimensions are approximate.

PLAIN CORNICES

designer's
edge MILLWORK

Polyurethane DEM Mouldings
Polystyrene RPS Mouldings
Duropolymer® CX Mouldings

100% RECYCLED POLYSTYRENE

CX112



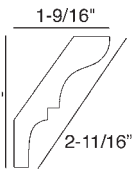

96" Length

Duropolymer®

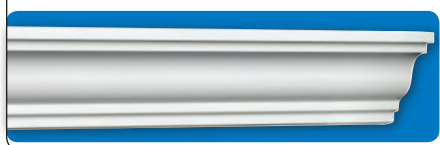

1-9/16"
2-3/16"
2-11/16"

RPS-0207 (8 Ft.)
RPS-0207-12 (12 Ft.)

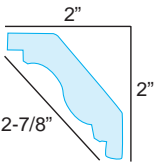
2"
2-7/8"

CX108



96" Length

Duropolymer®

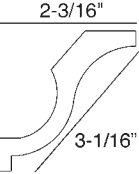

2-3/16"
2-3/16"
3-1/16"

DEM-210



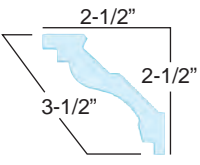

94-1/2" Length



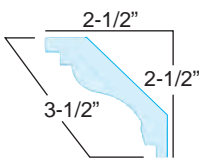

2-1/2"
2-1/2"
3-1/2"

RPS-2210 (8 Ft.)
RPS-2210-12 (12 Ft.)

2-1/2"
2-1/2"
3-1/2"

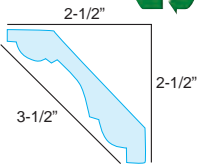

RPS-0189

2-1/2"
2-1/2"
3-1/2"

96" Length

RPS-0049 (8 Ft.)
RPS-0049-12 (12 Ft.)

2"
3"
3-1/2"

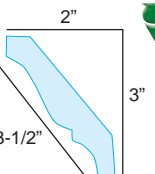
Matches WM49

CX100



96" Length

Duropolymer®

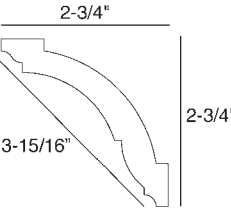

2-3/4"
2-3/4"
3-15/16"



DEM-220



94-1/2" Length



3"
3"
4-1/8"

RPS & **DUROPOLYMER®**

- HIGH IMPACT
- Recommended blade 10" Blade, 200 Teeth

information can be found on page 777

All dimensions are approximate.

PLAIN CORNICES

designer's
edge MILLWORK

Polyurethane DEM Mouldings
Polystyrene RPS Mouldings
Duropolymer® CX Mouldings

100% RECYCLED POLYSTYRENE

RPS-0183 (8 Ft.)
RPS-0183-12 (12 Ft.)

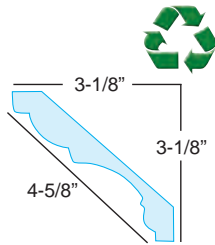

CX123



96" Length

Duropolymer®

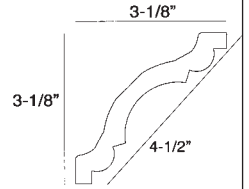

DEM-235



94-1/2" Length

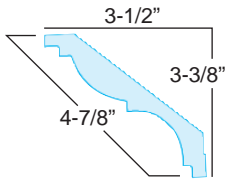

RPS-2225



96" Length

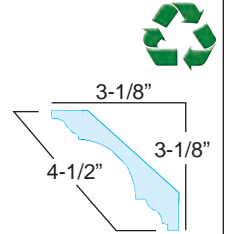

RPS-0045 (8 Ft.)
RPS-0045-12 (12 Ft.)



Matches WM45

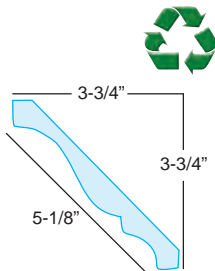

DEM-230



94-1/2" Length

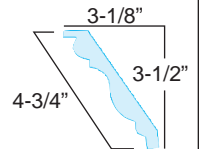

CX127



96" Length

Duropolymer®

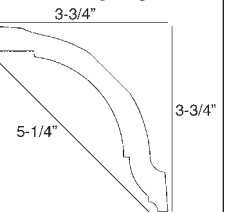

DEM-240

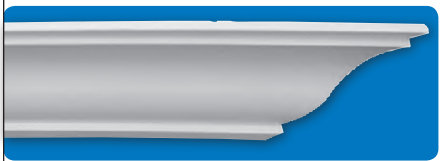

94-1/2" Length

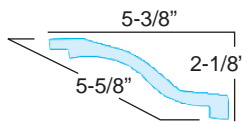

- HIGH IMPACT
 - Recommended blade 10" Blade, 200 Teeth
- information can be found on page 777



All dimensions are approximate.

PLAIN CORNICES

designer's
edge MILLWORK

Polyurethane DEM Mouldings
Polystyrene RPS Mouldings
Duropolymer® CX Mouldings

100% RECYCLED POLYSTYRENE

DEM-244



94-1/2" Length

DEM-250



94-1/2" Length

CX106

Duropolymer®



6'6" Length

DEM-255



94-1/2" Length

DEM-260



96" Length

DEM-265



94-1/2" Length

DEM-271

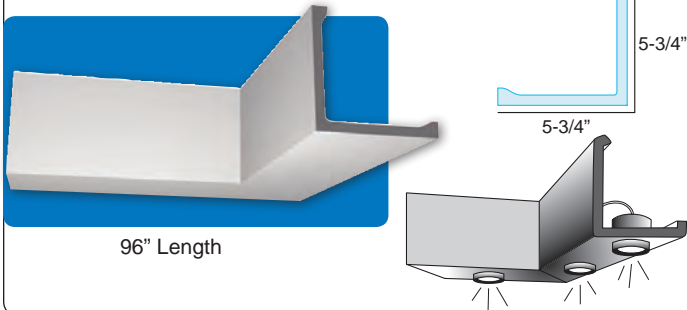

96" Length

DEM-270



94-1/2" Length

DEM-272



94-1/2" Length

Great for
indirect lighting

DUROPOLYMER® ● HIGH IMPACT
● Recommended blade 10" Blade, 200 Teeth
product information can be found on page 777

All dimensions are approximate.

LARGE PLAIN CORNICICES

designer's
edge MILLWORK

Polyurethane DEM Mouldings
Polystyrene RPS Mouldings

100% RECYCLED POLYSTYRENE



DEM-273

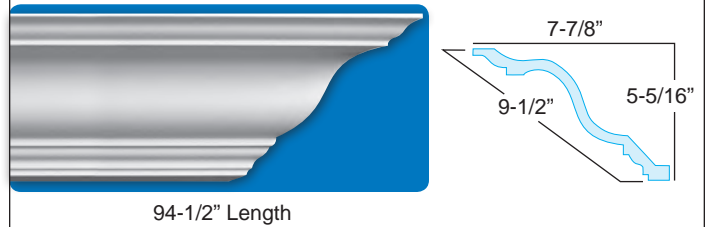

CORNERS

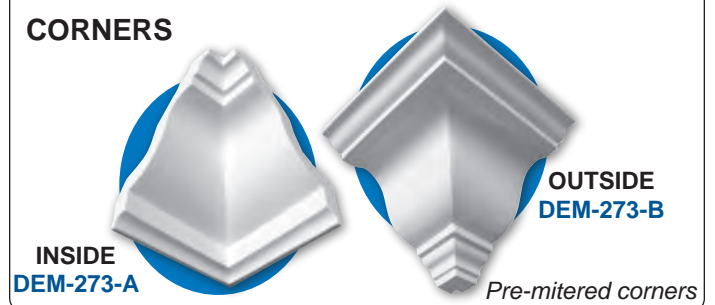

DEM-275



DEM-280

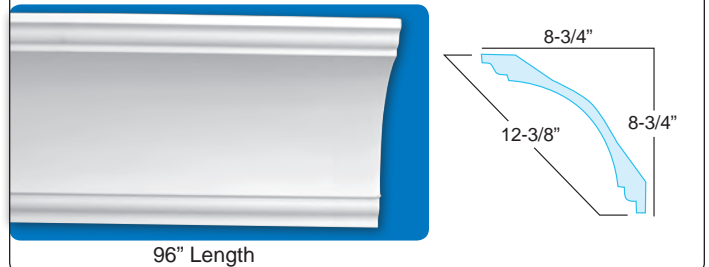

DEM-283

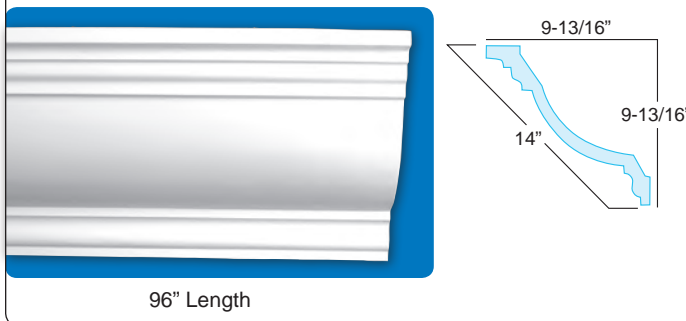

All dimensions are approximate.

COMBINATION MOULDINGS



Polyurethane DEM Mouldings

Two Sizes Available

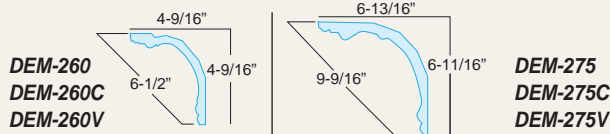

DEM-260
DEM-260C
DEM-260V

DEM-275
DEM-275C
DEM-275V

Crown Moulding



DEM-260 length 96"

DEM-275 length 94-1/2"

Decorative Center Moulding



DEM-260C length 96"

DEM-275C length 94-1/2"

Inside "V" Corner Moulding



DEM-260V length 94"

DEM-275V length 94"

DEM-260V and DEM-275V can be mitered to create 2 inside corners

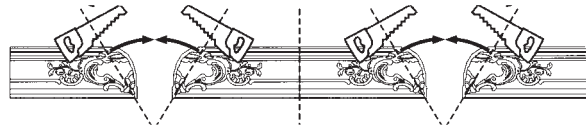

All dimensions are approximate.

DECORATIVE CORNERS

Polyurethane DEM Mouldings
Polystyrene RPS Mouldings

100% RECYCLED POLYSTYRENE



DEM-10



OUTSIDE CORNER
3" H 4-1/8" Proj.

DEM-11



3-1/8" W

CENTER
3" H 3" Proj.

DEM-12

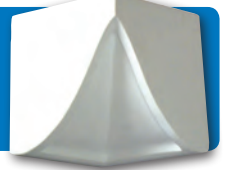

INSIDE CORNER
3" H 4-1/8" Proj.

Works with our DEM Mouldings:

DEM-105...page 779
DEM-111...page 779

DEM-113...page 779
DEM-114...page 779

DEM-115...page 779
DEM-116...page 779

Works with our RPS Mouldings:

RPS-0049...page 789
RPS-0189...page 789

RPS-0207...page 789

RPS-2210...page 789

DEM-13



OUTSIDE CORNER
3-3/4" H
5" Proj.

DEM-14



INSIDE CORNER
3-3/4" H
5" Proj.

Works with our DEM Mouldings:

DEM-117...page 780
DEM-120...page 780

DEM-122...page 780
DEM-130...page 781

DEM-220...page 789
DEM-230...page 790

Works with our RPS Mouldings:

RPS-0049...page 789
RPS-0189...page 789

RPS-1120...page 780
RPS-2210...page 789

RPS-2225...page 790

DEM-15



OUTSIDE CORNER
4" H 5-1/4 Proj.

DEM-16



4" W

CENTER
4" H 4" Proj.

DEM-17



INSIDE CORNER
4" H 5-1/4" Proj.

Works with our DEM Mouldings:

DEM-115...page 779
DEM-116...page 779
DEM-117...page 780
DEM-121...page 780

DEM-125...page 780
DEM-126...page 781
DEM-130...page 781

DEM-136...page 781
DEM-220...page 789
DEM-230...page 790

Works with our RPS Mouldings:

RPS-0049...page 789
RPS-0183...page 790

RPS-2210...page 789

RPS-2225...page 790

DEM-18



OUTSIDE CORNER
4-3/4" H 6-3/4" Proj.

DEM-19



4-3/4" W

CENTER
4-3/4" H 4-5/8" Proj.

DEM-20



INSIDE CORNER
4-3/4" H 6-3/4" Proj.

Works with our DEM Mouldings:

DEM-121...page 780
DEM-132...page 781
DEM-142...page 782

DEM-146...page 782
DEM-150...page 783
DEM-157...page 783

DEM-235...page 790
DEM-244...page 791

Works with our RPS Mouldings:

RPS-0045...page 790

RPS-0183...page 790

DEM-21



OUTSIDE CORNER
4-3/4" H 6-1/2" Proj.

DEM-22



4-3/4" W

CENTER
4-3/4" H 4-3/4" Proj.

DEM-23



INSIDE CORNER
4-3/4" H 6-1/2" Proj.

Works with our DEM Mouldings:

DEM-125...page 780
DEM-142...page 782
DEM-146...page 782

DEM-150...page 783
DEM-157...page 783

DEM-235...page 790
DEM-244...page 791

Works with our RPS Mouldings:

RPS-0045...page 790

RPS-0183...page 790

All dimensions are approximate.

TRIM FAST™ THE MITER-FREE CORBEL SYSTEM

★ **PATENT
PENDING**

The Industries Only Miter-Free, Interlocking Corbel & Crown Moulding System!

Solid wood corbels are available for inside corners, outside corners & centers eliminating the need for complicated miter cuts & noticeable seems at butt joints.



- Corbels work with corresponding mouldings only
- Mouldings should be cut approximately 3/4" longer than spacing of corbels and snapped into place

- Simply fasten corbels to wall using included hardware

Crowns & Corbels are finished in a satin white & can be painted with a quality latex paint if desired

POLYSTYRENE CROWN MOULDINGS: AVAILABLE IN 8 FT. LENGTHS

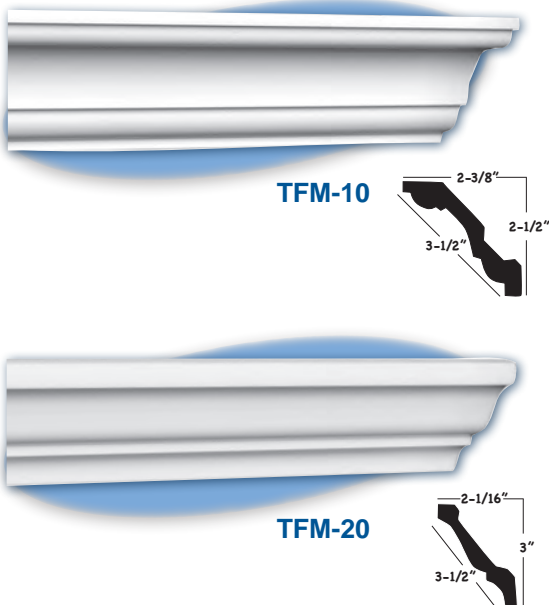

CORBELS:

ALLOWS FOR MITER-FREE SYSTEM

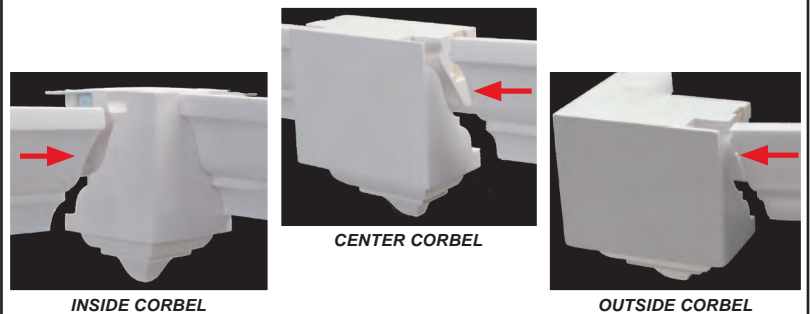

FOR USE WITH TFM10

PART #	DESCRIPTION	WIDTH	HEIGHT	PROJ.
TF10-IC	Inside Corbel	3-1/8"	4-1/2"	3-1/8"
TF10-OC	Outside Corbel	4-1/2"	4-1/2"	2-3/8"
TF10-CC	Center Corbel	4"	4-1/2"	2-3/8"

FOR USE WITH TFM20

PART #	DESCRIPTION	WIDTH	HEIGHT	PROJ.
TF20-IC	Inside Corbel	2-3/4"	5"	2-3/4"
TF20-OC	Outside Corbel	4"	5"	2"
TF20-CC	Center Corbel	4"	5"	2"

ADHESIVE

- Use as adhesive or filler
- Eco-friendly, low VOC's
- Fast cure • Paintable • Non-yellowing



MP-25-ADH

LARGE DECORATIVE DROPS



High Density Polyurethane

Our corner and center blocks allow you to install cornice mouldings quickly and easily with no need for mitering. Adding these architectural embellishments will highlight the beauty and visual appeal that crown moulding offers.

- **One piece pre-assembled, Corners & Centers.**
No need to construct your own center and outside corner, we've done the work for you, saving valuable time.
- Primed and ready for paint.
- Lightweight and easy to install, corners and centers can be cut with a saw, nail and glue just like wood.

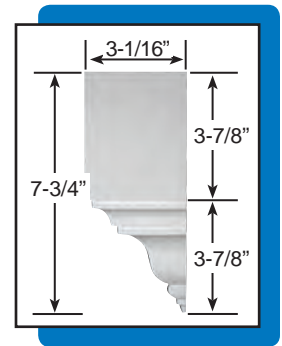
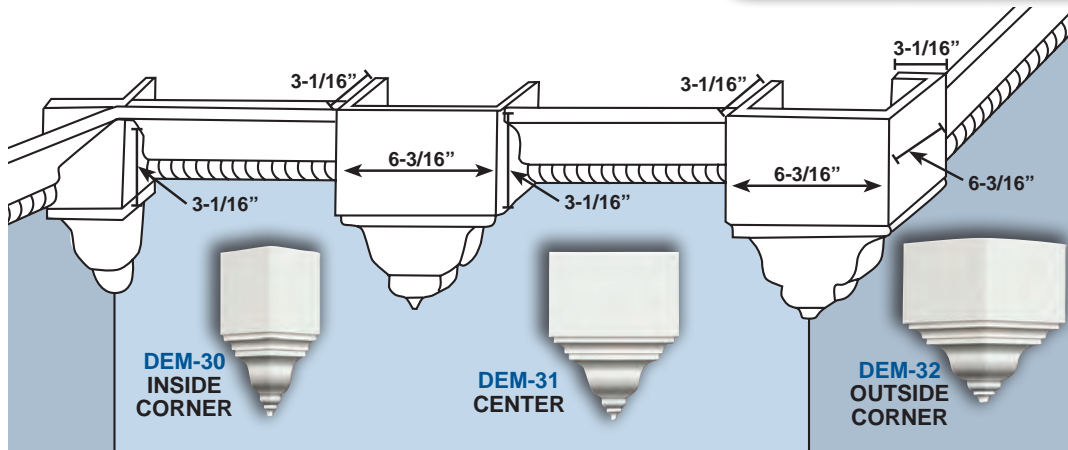
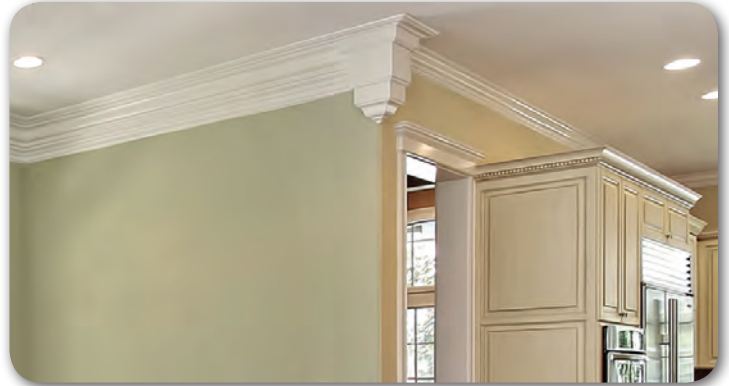

Crown Moulding cannot exceed 3-3/16" height and 3" projection
Many great crown options can be found on pages 779-780.

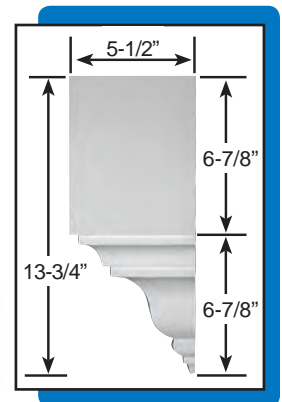
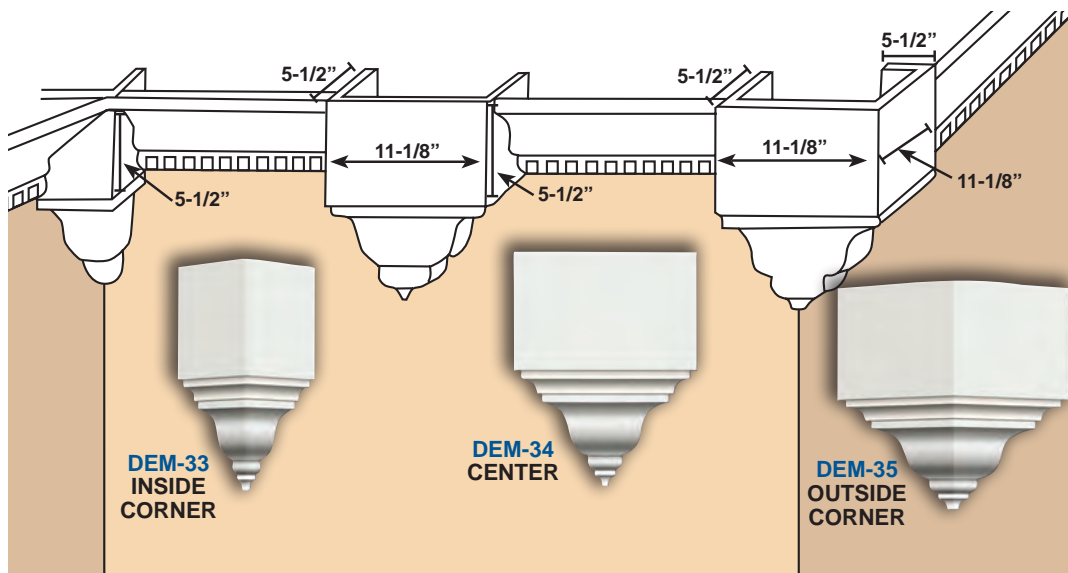

Crown Moulding cannot exceed 6-3/4" height and 5-1/2" projection
Many great crown options can be found on pages 784-785.

ADH1

10.6 oz tube

PL Premium Adhesive

Approximate adhesive yields*

Mouldings 2" + Under – 60'

Mouldings 2 - 5" – 45'

Mouldings 5" + Over – 30'

**Yields are approximate and based on average conditions and installation technique.*



All dimensions are approximate.

DECORATIVE PANEL MOULDINGS



Polyurethane DEM Mouldings
Polystyrene RPS Mouldings
Duropolymer® PX Mouldings

100% RECYCLED POLYSTYRENE

DEM-303



96" Length Design Repeat: 7/8"

5/8"



1" Max Radius 8"

DEM-303F - Flexible



93" Length Design Repeat: 7/8"

RPS-3305



96" Length Design Repeat: 1"

3/8"



1-1/4"

Corner Available:
DEM-305A, See Page 803

RPS-3307



96" Length Design Repeat: 2-1/4"

7/8"



1-3/8"

PX130



96" Length

Duropolymer®

3/4"



1-9/16"



DEM-311



94-1/2" Length Design Repeat: 2-1/2"

3/4"



1-5/8"

Corner Available:
DEM-311A, See Page 803

DEM-313



94-1/2" Length Design Repeat: 10"

1-1/8"



1-5/8"

Corner Available:
DEM-313A, See Page 803

DEM-314

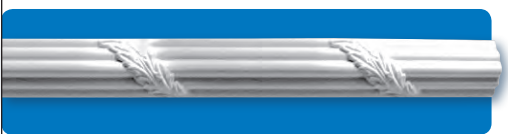

96" Length
Design Repeat: 7"

3/4"



1-7/8"

Over Corner Available:
DEM-314A & DEM-314-L/R, See Page 803

DEM-315



94-1/2" Length Design Repeat: 2-3/8"

1"



1-7/8"

Corner Available:
DEM-315A, See Page 804

RPS-3319



96" Length Design Repeat: 1-3/4"

5/8"



2"

Corner Available:
DEM-319A, See Page 804



- HIGH IMPACT
 - Recommended blade 10" Blade, 200 Teeth
- information can be found on page 777

All dimensions are approximate.

DECORATIVE PANEL MOULDINGS

designer's
edge MILLWORK

Polyurethane DEM Mouldings
Polystyrene RPS Mouldings
Duropolymer® PX Mouldings

100% RECYCLED POLYSTYRENE

DEM-320



96" Length Design Repeat: 1-3/8"

7/8"

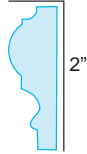

Corner Available:
DEM-320A, See Page 804

PX114



96" Length

Duropolymer®

1-1/16"

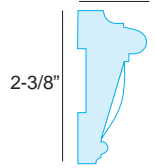

DEM-321



94-1/2" Length Design Repeat: 1-3/8"

3/4"

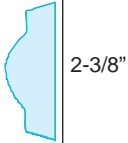

Corner Available:
DEM-321A, See Page 804

DEM-322



96" Length Design Repeat: 1-1/2"

3/4"

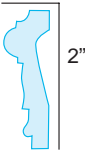

DEM-323



94-1/2" Length Design Repeat: 1-1/4"

3/8"



DEM-326



96" Length Design Repeat: 1/2"
Dots 24 per 12"

1"



DEM-327



94-1/2" Length Design Repeat: 5-1/2"

1/2"

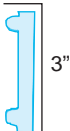

DEM-328



96" Length Design Repeat: 7"

1-1/8"

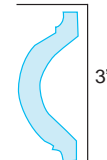

DUROPOLYMER® • HIGH IMPACT
• Recommended blade 10" Blade, 200 Teeth
product information can be found on page 777

All dimensions are approximate.

DECORATIVE PANEL MOULDINGS



Polyurethane DEM Mouldings
Polystyrene RPS Mouldings

100% RECYCLED POLYSTYRENE

DEM-330

96" Length Design Repeat: 3/4"

DEM-331

94-1/2" Length Design Repeat: 1-3/4"

Corner Available:
DEM-331A, See Page 804

DEM-332

96" Length Design Repeat: 5"

DEM-336

94-1/2" Length Design Repeat: 4"

Corner Available:
DEM-336A,
See Page 804

FRIEZES



Polyurethane DEM Mouldings
Polystyrene RPS Mouldings

100% RECYCLED POLYSTYRENE

DEM-333

94-1/2" Length Design Repeat: 6-1/4"

DEM-334

96" Length Design Repeat: 12"

DEM-335

94-1/2" Length Design Repeat: 19"

DEM-381

94-1/2" Length Design Repeat: 3"

DEM-390

96" Length Design Repeat: 12"

DEM-392

96" Length Design Repeat: 5-1/8"

DEM-397

96" Length Design Repeat: 1"

All dimensions are approximate.

PLAIN PANEL MOULDINGS



Polyurethane DEM Mouldings
Polystyrene RPS Mouldings
Duropolymer® PX Mouldings

100% RECYCLED POLYSTYRENE

ASTRAGAL
RPS-0167

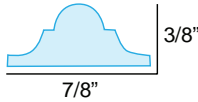

Matches LWM135

96" Length

PX116



Duropolymer®

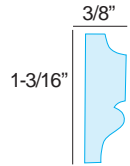

96" Length

BASE CAP
RPS-0234

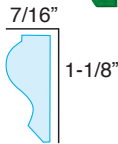

96" Length

BASE CAP
RPS-0164 (8 Ft.)
RPS-0164-12 (12 Ft.)

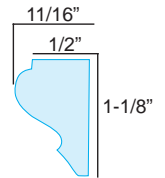

Matches WM164

BASE CAP
RPS-0282

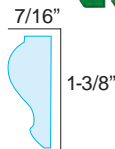

96" Length

RPS-4400

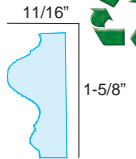

96" Length

*Corner Available:
DEM-400A, See Page 805*

PX120

Duropolymer®

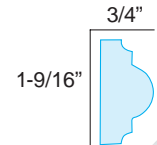

78" Length

PX120A

(8 pcs. per carton)

A = 7-1/2"

B = 2-1/4"

C = 3/4"

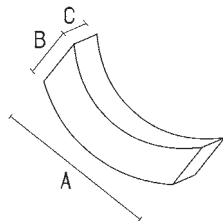

Inside Radius Approximately 5"

RPS-4405



96" Length

*Corners Available:
DEM-405B,C,D,E,F, See Page 805*

& **HIGH IMPACT**
Recommended blade 10" Blade, 200 Teeth
DUROPOLYMER® *information can be found on page 777*



All dimensions are approximate.

PLAIN PANEL MOULDINGS



Polyurethane DEM Mouldings
Polystyrene RPS Mouldings
Duropolymer® PX Mouldings

100% RECYCLED POLYSTYRENE

RPS-4410



96" Length

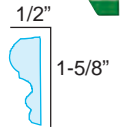

1/2"
1-5/8"



Corner Available:
DEM-410A, See Page 805

DEM-415



94-1/2" Length



5/8"
2"

Corners Available:
DEM-415A, DEM-415B
See Page 805

PX113



96" Length

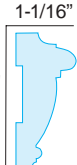

1-1/16"
2-3/8"

Duropolymer®

RPS-0390



96" Length

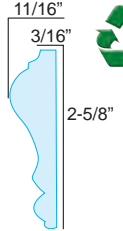

11/16"
3/16"
2-5/8"



Matches WM390

DEM-419



94-1/2" Length

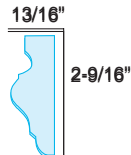

13/16"
2-9/16"

Corner Available:
DEM-419A, See Page 805

PX102

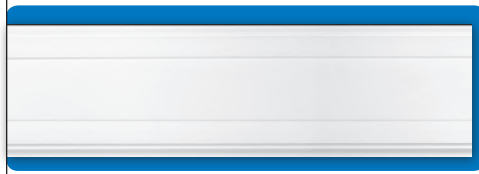

96" Length

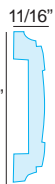

11/16"
3-1/8"

Duropolymer®

DEM-420



94-1/2" Length

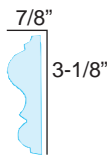

7/8"
3-1/8"

DEM-425



94-1/2" Length



1"
3-3/8"



RPS-0298



96" Length



1"
3-1/2"



Matches WM298

 &  • HIGH IMPACT
• Recommended blade 10" Blade, 200 Teeth
DUROPOLYMER® *information can be found on page 777*

All dimensions are approximate.

Mitreless Cover & Butt Joint Corner

The 90° Mitreless Corner Cover & 180° Mitreless Straight Cover

These products are decorative and designed to eliminate mitering and butt joints. The covers will hide any imperfections on moulding edges and save time on installation.

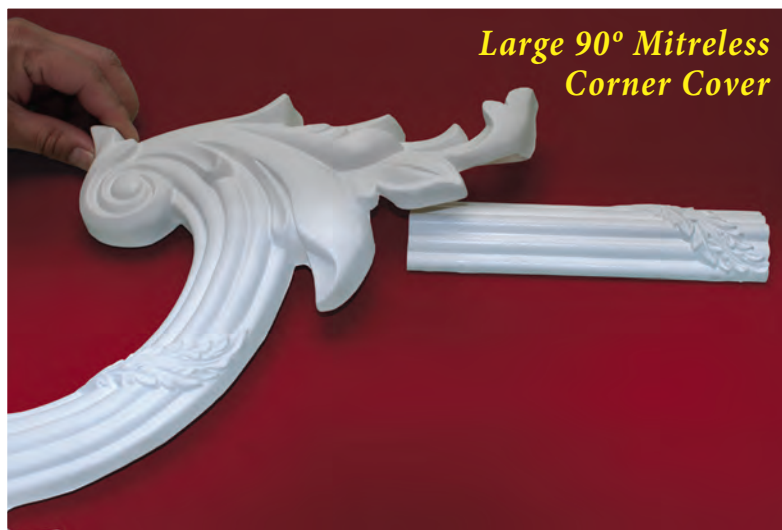

Our corners allow for miscuts up to 1/4"

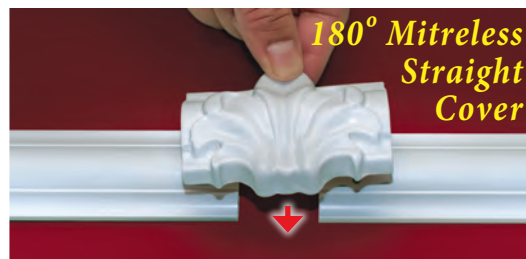

The 90° Butt Joint Corner & 180° Straight Butt Joint

When two ends of material are joined by butting them together using adhesive and caulk or other type of filler. These items need to have a tight fit and may require sanding, build up and caulking.



All dimensions are approximate.

designer's
edge MILLWORK

Polyurethane - DEM Mouldings
100% Recycled Polystyrene - RPS Mouldings

RPS-3305 1-1/4" x 3/8" x 96"



90° Butt Joint Corner

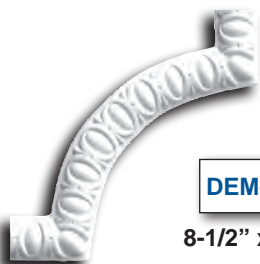

DEM-305A

8-1/2" x 8-1/2"

DEM-313 1-5/8" x 1-1/8" x 94-1/2"



90° Butt Joint Corner



DEM-313A

8-7/8" x 8-7/8"

DEM-314 1-7/8" x 3/4" x 96"



90° Mitreless Corner Covers



DEM-314A

14-1/4" x 14-1/4"



DEM-314-L/R

16" W x 18" H
Left and Right

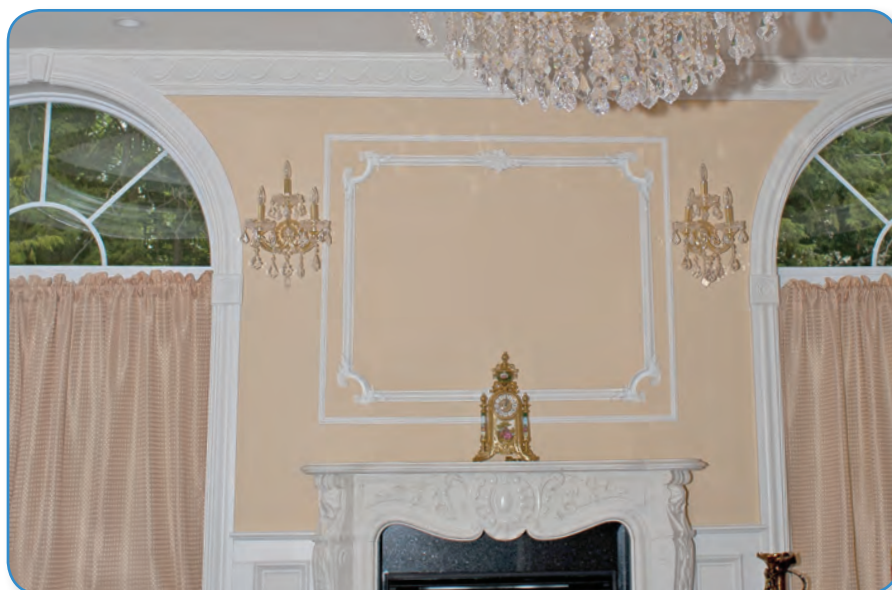

Shown with DEM-314A

All dimensions are approximate.

designer's
edge MILLWORK

Polyurethane - DEM Mouldings
100% Recycled Polystyrene - RPS Mouldings

DEM-315 1-7/8" x 1" x 94-1/2"



90° Butt Joint Corners

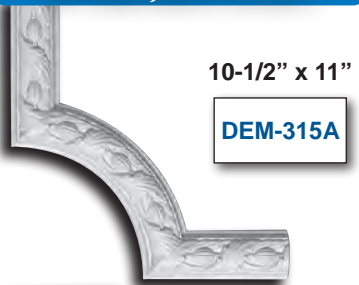

10-1/2" x 11"

DEM-315A

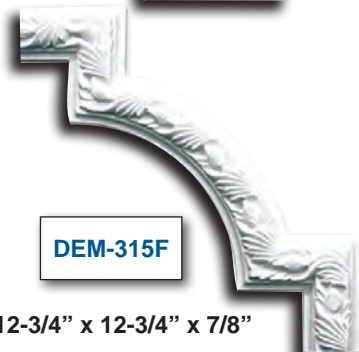

DEM-315F

12-3/4" x 12-3/4" x 7/8"

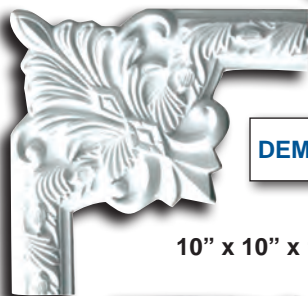

DEM-315E

10" x 10" x 15/16"



DEM-315C

9-7/8" x 9-7/8" x 1-1/8"

Rosette



2-1/2" Dia. x 1/2" Thick

DEM-315D

DEM-320 2" x 7/8" x 96"



90° Mitreless Corner Cover

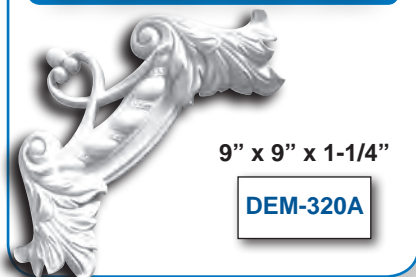

9" x 9" x 1-1/4"

DEM-320A

DEM-321 2-3/8" x 3/4" x 94-1/2"



90° Butt Joint Corner

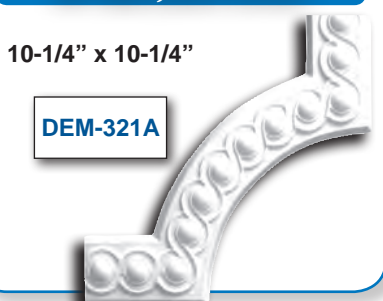

10-1/4" x 10-1/4"

DEM-321A



DEM-331 3-1/8" x 3/4" x 94-1/2"



90° Butt Joint Corner

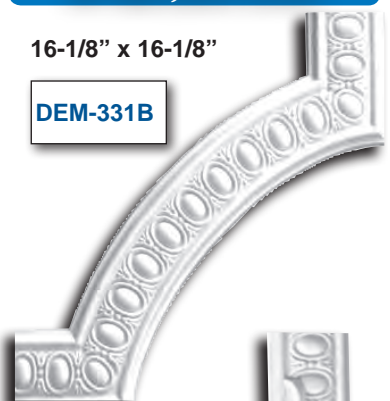

16-1/8" x 16-1/8"

DEM-331B

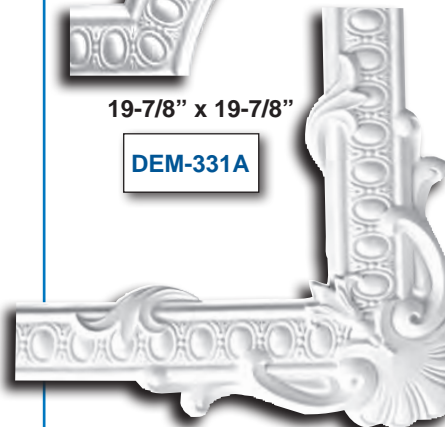

19-7/8" x 19-7/8"

DEM-331A

DEM-336 4" x 1-1/4" x 96"



90° Mitreless Corner Cover

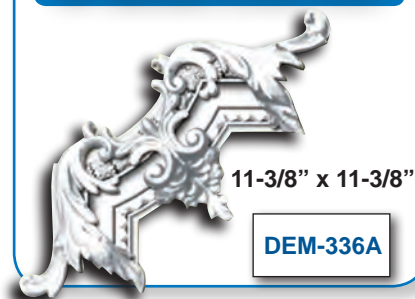

11-3/8" x 11-3/8"

DEM-336A

All dimensions are approximate.

Polyurethane - DEM Mouldings
100% Recycled Polystyrene - RPS Mouldings

RPS-4400 1-5/8" x 11/16" x 96"



90° Mitreless Corner Cover

3" x 3"

DEM-400-E



Hand Carved Wood

180° Mitreless Corner Cover

3-1/4" x 2-3/4"

Hand Carved Wood



DEM-400-F

90° Butt Joint Corner

5-1/16" x 5-1/16"

DEM-400A



7-3/8" x 7-3/8"

DEM-400B



Shown with DEM-400A



RPS-4405 1-1/2" x 5/8" x 96"



90° Mitreless Corner Cover



9" x 9"

DEM-405D

90° Mitreless Corner Cover

3-1/8" x 3-1/8"

DEM-405-E



Hand Carved Wood

180° Mitreless Straight Cover

Hand Carved Wood



3-1/4" x 2-3/4"

DEM-405-F

180° Butt Joint Corner

6-1/8" x 6-1/8"

DEM-405C



180° Straight Butt Joint



9-1/4" x 4-3/8"

DEM-405B

RPS-4410 1-5/8" x 1/2" x 96"



90° Butt Joint Corner

7-3/4" x 7-3/4"

DEM-410A



DEM-415 2" x 5/8" x 94-1/2"



90° Mitreless Corner Cover



10" x 10"

DEM-415A

180° Mitreless Straight Cover



15" x 4"

DEM-415B

DEM-419 2-9/16" x 13/16" x 94-1/2"



90° Mitreless Corner Cover

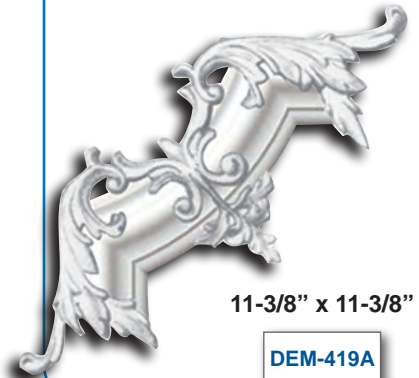

11-3/8" x 11-3/8"

DEM-419A

All dimensions are approximate.

COMMON MOULDINGS



Polyurethane DEM Mouldings
Polystyrene RPS Mouldings
Duropolymer® CX Mouldings

100% RECYCLED POLYSTYRENE

DOOR STOP
RPS-0935

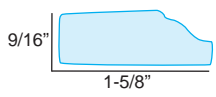
9/16" 1-5/8"

96" Length



CX134





96" Length

1-3/16" 1-3/16" 88° 1-11/16"

Duropolymer®

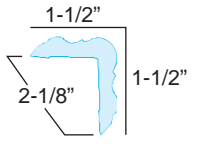
DEM-205

94-1/2" Length

1-1/2" 2-1/8" 1-1/2"

ANGLE MOULDING
RPS-2205 (8 Ft.)
RPS-2205-12 (12 Ft.)



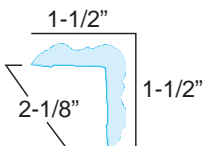

96" Length

1-1/2" 2-1/8" 1-1/2"

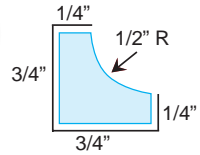

SCOTIA MOULDING
RPS-0093 (8 Ft.)
RPS-0093-12 (12 Ft.)





Matches WM93 96" Length

1/4" 1/2" R 3/4" 1/4" 3/4"

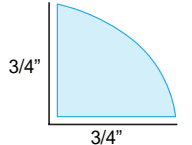

QUARTER ROUND
RPS-0105 (8 Ft.)
RPS-0105-12 (12 Ft.)





Matches WM105 96" Length

3/4" 3/4"

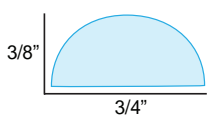

HALF ROUND
RPS-0052 (8 Ft.)
RPS-0052-12 (12 Ft.)





Matches RB122 96" Length

3/8" 3/4"

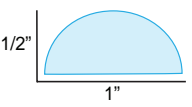

HALF ROUND
RPS-0120 (8 Ft.)
RPS-0120-12 (12 Ft.)





Matches WM120 96" Length

1/2" 1"

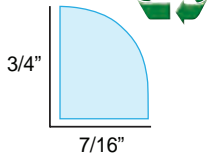

SHOE MOULDING
RPS-0127-07





Matches WM127 96" Length

3/4" 7/16"

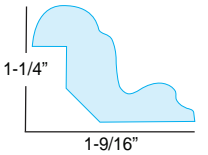

CAP/BACKBAND
RPS-0490 (8 Ft.)
RPS-0490-12 (12 Ft.)





96" Length For 3/4" Board

1-1/4" 1-9/16"

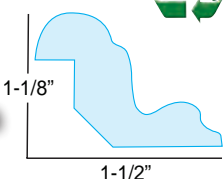

FOR 1/2" BOARD
RPS-0494





96" Length For 1/2" Board

1-1/8" 1-1/2"

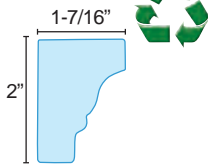

New
RPS-0205

96" Length

1-7/16" 2"



RPS & DUROPOLYMER® • HIGH IMPACT • Recommended blade 10" Blade, 200 Teeth
information can be found on page 777

All dimensions are approximate.

CASE MOULDINGS

designer's
edge MILLWORK

Polyurethane DEM Mouldings
Polystyrene RPS Mouldings

100% RECYCLED POLYSTYRENE

RPS-0493-07



96" Length for 1/2" Board

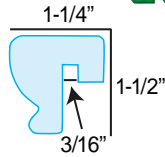

RPS-0491-07



96" Length for 3/8" Board

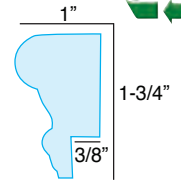

RPS-0376



Matches WM376

96" Length

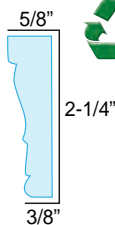

DECORATIVE KEYSTONE
APPLIQUE
RPS-0376-A

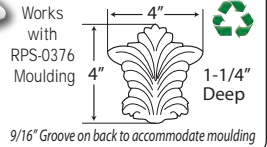

RPS-0327



Matches WM327

96" Length

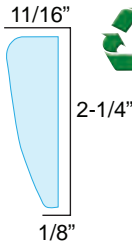

RPS-0361



Matches WM361

96" Length

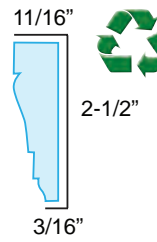

CAP/BACKBAND
RPS-0492-07



96" Length for 3/8" Board

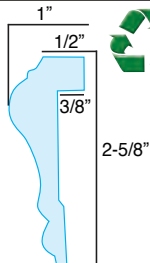

DEM-430



94-1/2" Length

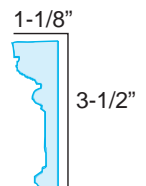

RPS-0299



Matches RB3

96" Length

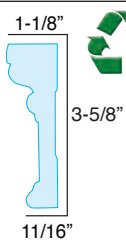

DEM-394



96" Length Design Repeat: 1-1/2"

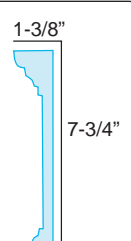

DEM-396



96" Length

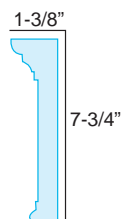

All dimensions are approximate.

RPS • HIGH IMPACT
Recommended blade 10" Blade, 200 Teeth
RPS PRODUCT information can be found on page 777

BASE MOULDINGS



Polyurethane DEM Mouldings
Polystyrene RPS Mouldings
Duropolymer® SX Mouldings

100% RECYCLED POLYSTYRENE

SX122 Duropolymer®

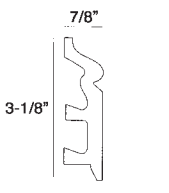

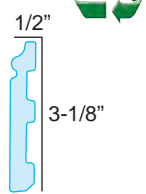

7/8"
3-1/8"
96" Length

RPS-0431

1/2"
3-1/8"
96" Length



SX137 Duropolymer®

9/16"
3-15/16"
96" Length

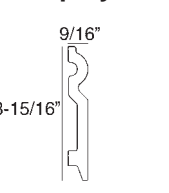
DEM-435
DEM-435-F - Flexible

1/2"
4"
94-1/2" Length 10" Max Radius on Flexible

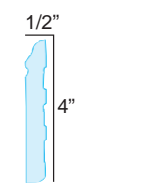
SX155 Duropolymer®

1"
4-3/8"
96" Length

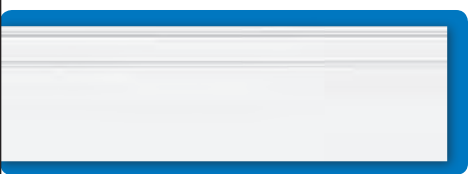
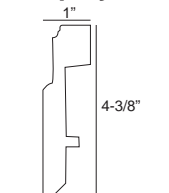
SX138 Duropolymer®



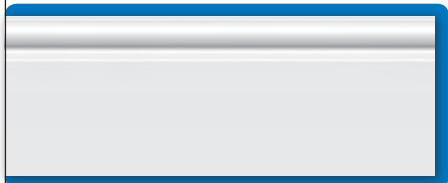
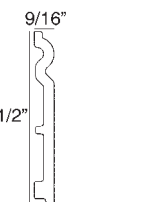

9/16"
5-1/2"
96" Length

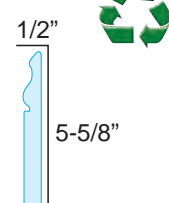
RPS-4475

1/2"
5-5/8"
Matches WM163E
96" Length



DEM-485

9/16"
7-3/8"
1"
94-1/2" Length

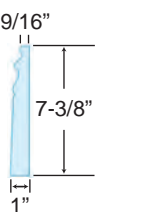
Inside Corner
DEM-485IC



7-3/8"
4-5/16" x 4-5/16" x 1"

Outside Corner
DEM-485OC

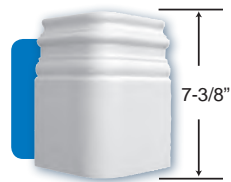

7-3/8"
4-3/4" x 4-3/4" x 1"

SX104 Duropolymer®

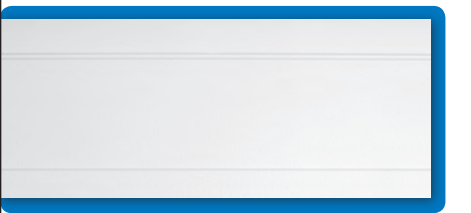
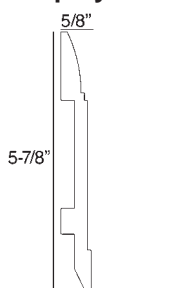
5/8"
5-7/8"
96" Length

 &  • HIGH IMPACT
• Recommended blade 10" Blade, 200 Teeth
DUROPOLYMER® *information can be found on page 777*

All dimensions are approximate.

DECORATIVE MEDALLIONS

designer's
edge MILLWORK

Polyurethane Architectural Elements

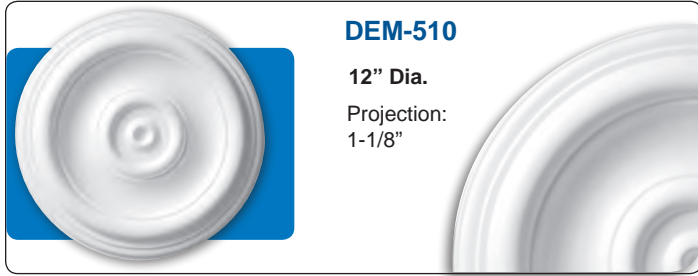

DEM-510

12" Dia.
Projection:
1-1/8"



DEM-513

15" Dia.
Projection:
1-3/4"



DEM-514

15-1/2" Dia.



DEM-519

18" Dia.
Projection:
1-1/2"
ID: 3-5/8"



DEM-516

16-1/2" Dia.
Projection:
1-1/2"

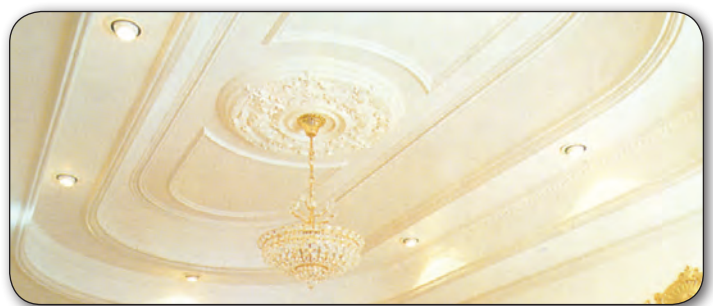

DEM-522

18" Dia.
Projection:
1-1/2"
ID: 3-5/8"



DEM-528

18" Dia.
Projection: 1-1/2"
ID: 3-5/8"



DEM-525

18" Dia.
Projection: 1-1/2"
ID: 3-5/8"



DEM-531

18" Dia.
Projection: 1-7/8"
ID: 3-5/8"

For our complete line
of CEILING DOMES,
see pgs. 770-774

All dimensions are approximate.

DECORATIVE MEDALLIONS

designer's
edge MILLWORK

Polyurethane Architectural Elements



DEM-534

18" Dia.
Projection:
1-3/8"
ID: 3-5/8"



DEM-537

18" x 18"
Projection: 1-5/8"
ID: 3-5/8"



DEM-540

19" Dia.
Projection:
1-5/8"



DEM-543

20-1/2" Dia.
Projection: 1-1/2"



DEM-546

21" Dia.
Projection: 1-3/8"



DEM-549

22-5/8" Dia.
Projection:
1-3/4"



DEM-552

23-5/8" Dia.
Projection:
2-3/4"



DEM-555

23-5/8" Dia.
Projection:
3-1/2"

For our complete line
of CEILING DOMES,
see pgs. 770-774

All dimensions are approximate.

DECORATIVE MEDALLIONS

designer's
edge MILLWORK

Polyurethane Architectural Elements

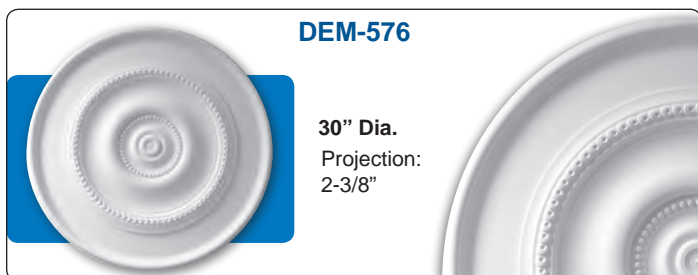
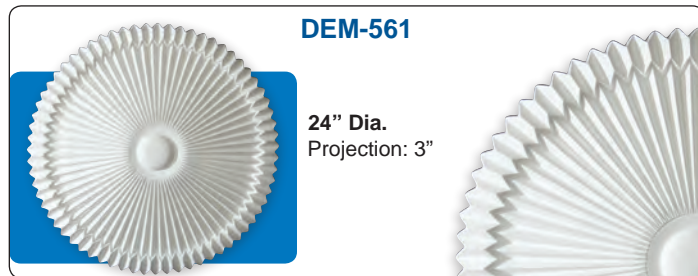

For our complete line
of CEILING DOMES,
see pgs. 770-774

All dimensions are approximate.

DECORATIVE MEDALLIONS

designer's
edge MILLWORK

Polyurethane Architectural Elements

DEM-590



Long Side: 17"
Short Side: 12"
Projection: 1-5/8"

DEM-592



Long Side: 18-1/2"
Short Side: 13-1/2"
Projection: 2"

DEM-594



Long Side: 23-3/4"
Short Side: 12-1/4"
Projection: 1-3/4"

DEM-596



Long Side: 30-1/2"
Short Side: 20"
Projection: 1-1/2"

DEM-598



Long Side: 36"
Short Side: 26"
Projection: 1-5/8"



STAIR BRACKETS

Note: All brackets shown are "Right" brackets

DEM-675R
DEM-675L

8-5/8" x 6-1/4" x 5/8"



DEM-678R
DEM-678L

11" x 7" x 5/8"



DEM-681R
DEM-681L

10-5/8" x 7" x 5/8"



DEM-684R
DEM-684L

8" x 6" x 3/4"

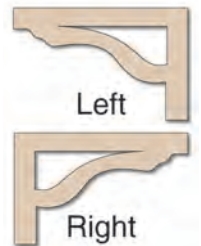

For our complete line
of CEILING DOMES,
see pgs. 770-774

All dimensions are approximate.



ADH1 10.6 oz tube
PL Premium Adhesive

Approximate adhesive yields*
Mouldings 2" + Under - 60'
Mouldings 2 - 5" - 45'
Mouldings 5" + Over - 30'

*Yields are approximate and based on average conditions and installation technique.

Domes

*For a complete line
see pages 770-774*



**Light
Cove**



Recessed



Elliptical



Surface Mount



Polyurethane DEM & Duropolymer® DX Architectural Elements

DEM-820 Series

ROSETTES



DEM-820A
4-3/4" H x 4-3/4" W
3/4" Projection

CASINGS



DEM-820
96" L x 4-1/2" W
3/4" Projection

PLINTHS



DEM-820C
7-3/4" H x 4-3/4" W
1" Projection

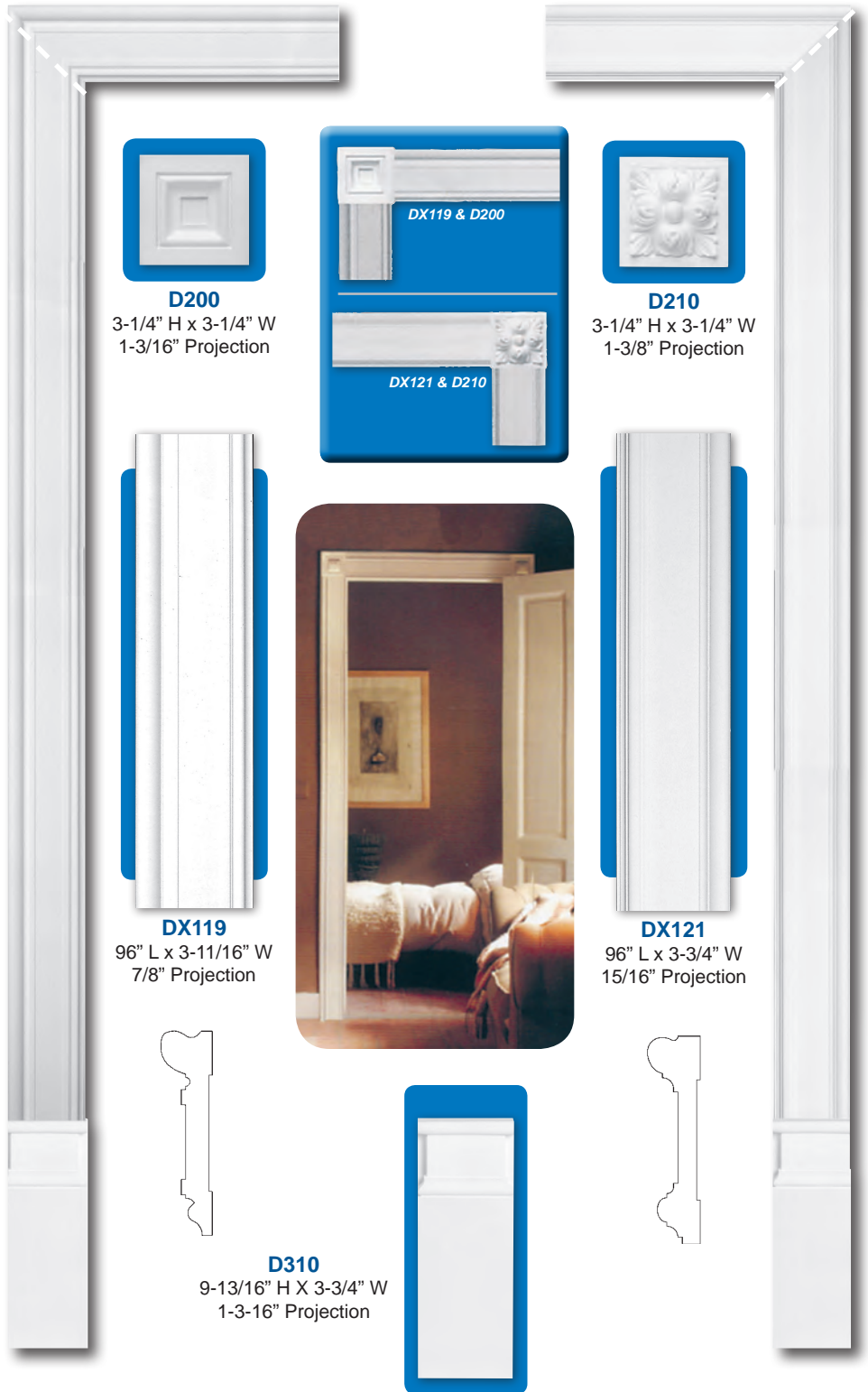

D200
3-1/4" H x 3-1/4" W
1-3/16" Projection



D210
3-1/4" H x 3-1/4" W
1-3/8" Projection

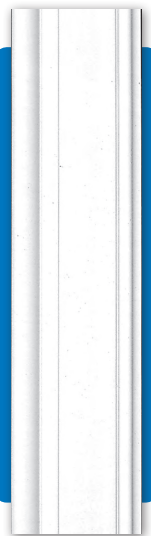

DX119
96" L x 3-11/16" W
7/8" Projection



DX121
96" L x 3-3/4" W
15/16" Projection

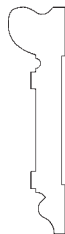

D310
9-13/16" H X 3-3/4" W
1-3-16" Projection



All dimensions are approximate.

PILASTERS

Polyurethane Architectural Elements



DEM-705 Series

DEM-705 Series
Pilaster Capitals
To Choose From:



DEM-705A
6-1/8" H x 10-1/2" W
3" Projection



DEM-705B
3" H x 9-3/8" W
2-1/4" Projection



DEM-705C
7-3/8" H x 8-1/4" W
2-1/4" Projection

CAPITALS

PILASTERS

DEM-705
78-3/4" L x 5-3/4" W
5/8" Projection



DEM-705F
12-1/8" H x 6-5/8" W
1" Projection

PLINTHS



All dimensions are approximate.

MASSIVE PILASTERS

designer's
edge MILLWORK

Polyurethane Architectural Elements

DEM-710 Series

DEM-710A

7-1/8" H x 17-1/2" W
2-5/8" Projection



DEM-710

78-3/4" L x 9-7/8" W
1-1/8" Projection

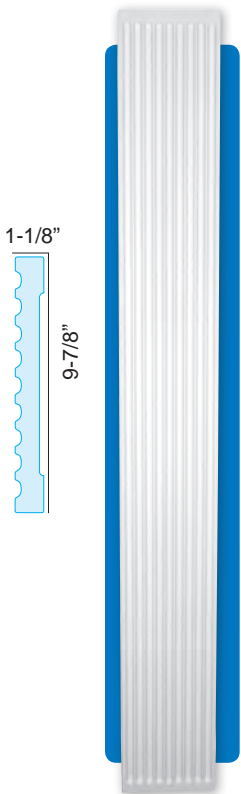

DEM-710B

6-1/4" H x 13-1/8" W
2-3/4" Projection



CAPITALS

DEM-715 Series

DEM-715A

17" H x 21-5/8" W
7-1/2" Projection



DEM-715

78-3/4" L x 12-1/2" W
1-1/8" Projection

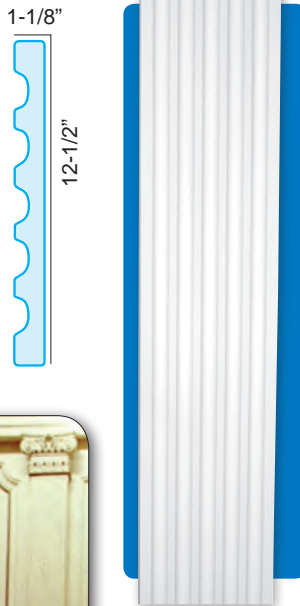

DEM-715B

20-7/8" H x 15" W
2-1/8" Projection



PILASTERS

DEM-720 Series

DEM-720A

25-1/4" H x 25-3/8" W
8-1/4" Projection



DEM-720

94-1/2" L x 17-3/4" W
1-1/2" Projection

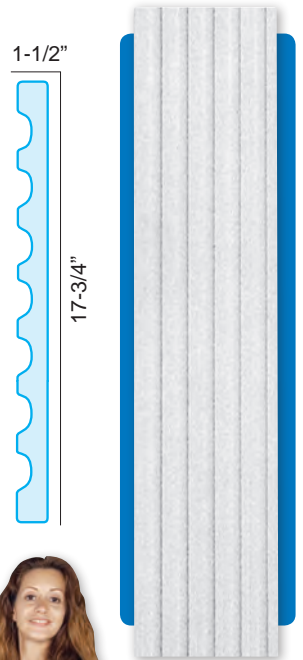

DEM-720B

31-5/8" H x 23-5/8" W
5-1/2" Projection



All dimensions are approximate.



Polyurethane Architectural Elements

• For Interior & Exterior Applications. • Will not split, decay, warp or rot. • Primed and ready to paint.
 (When using as an exterior application, we recommend using a "UV" stabilized paint).

DEM-394

Must be purchased in full length pieces

1-3/8"

7-3/4"

96" Length Design Repeat: 1-1/2"

DEM-396

Must be purchased in full length pieces

1-3/8"

7-3/4"

96" Length

DEM-745

DEM-785-L

DEM-785-R



DEM-733

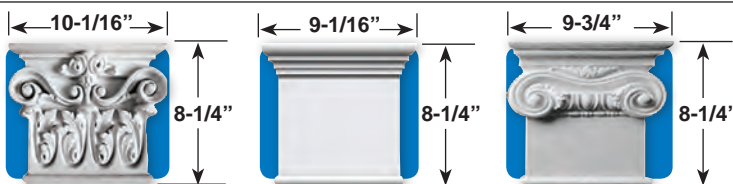
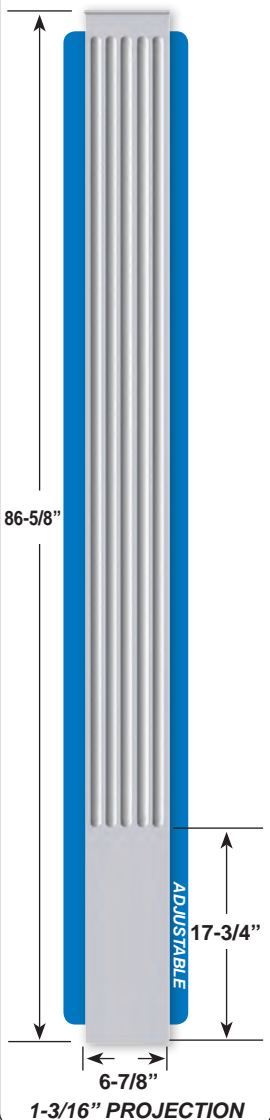

DEM-785-L (Left)
DEM-785-R (Right)

DEM-780-L (Left)
DEM-780-R (Right)

DEM-783-L (Left)
DEM-783-R (Right)

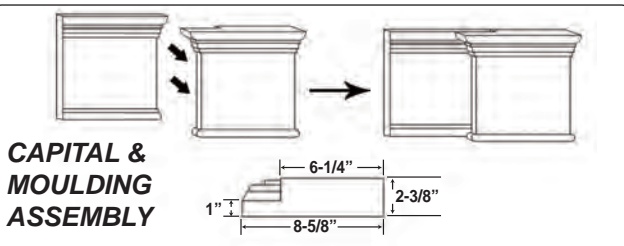

CAPITAL &
MOULDING
ASSEMBLY

DEM-780-L

DEM-396



DEM-780-R



DEM-745

1-3/4" PROJECTION

21"



DEM-740

1-3/4" PROJECTION

FIELD SANDING REQUIRED TO USE ACCESSORIES
WITH PANEL MOULDINGS

DEM-783-L

DEM-740

DEM-394

DEM-733

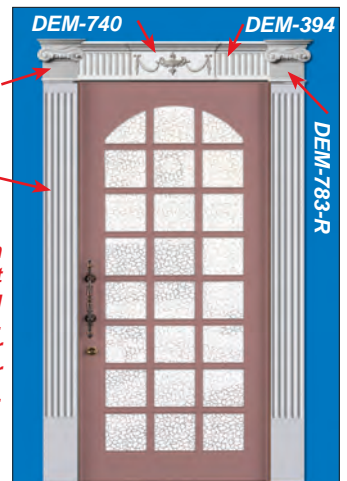

DEM-783-R

The examples shown can be applied to most entryways. Door opening configurations may vary. Please measure your specific opening or application.

All dimensions are approximate.



High Density Polyurethane Architectural Elements

- For Interior & Exterior Applications. • Will not split, decay, warp or rot. Primed and ready to paint.
- (When using as an exterior application, we recommend using a "UV" stabilized paint).

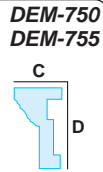
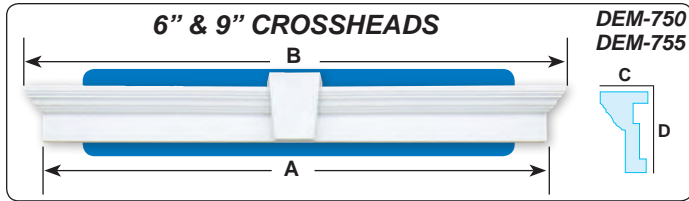

Can expand up to approximately 11' using: two DEM-755 + one DEM-765

CROSSHEADS

PART #	A	B	C	D
DEM-750	59-15/16"	63-3/4"	3"	6-1/8"
DEM-755	67-3/4"	72-5/8"	4"	9"

KEYSTONES

PART #	A	B	C	WORKS WITH CROSSHEAD
DEM-760	7-1/16"	5-3/4"	3-15/16"	DEM-750
DEM-765	11-7/16"	8-1/4"	6"	DEM-755



PILASTERS w/attached cap & adjustable plinth

PART #	DESCRIPTION	HEIGHT	WIDTH	PROJ.	PLINTH HEIGHT
DEM-730	Fluted Pilaster	85"	6-1/2"	2-3/4"	8-5/8"
DEM-735	Raised Panel Pilaster	87"	7"	2-1/8"	14-1/2"

FIELD SANDING REQUIRED TO USE ACCESSORIES WITH PANEL MOULDINGS

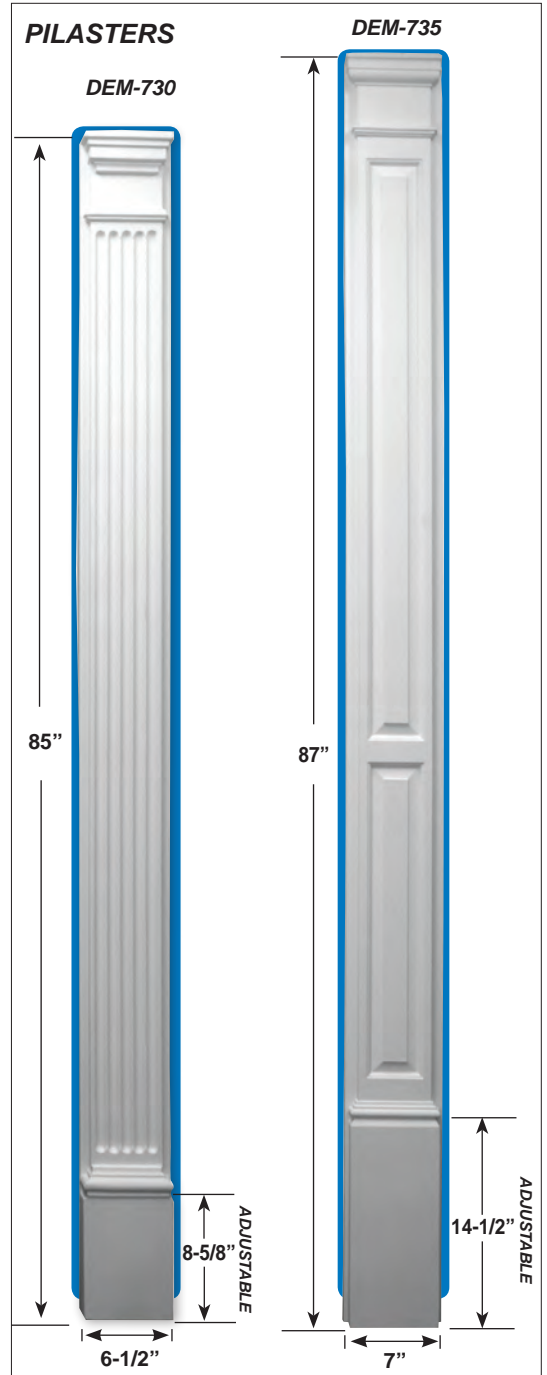

All dimensions are approximate.

RECESSED NICHES

designer's
edge MILLWORK

Polyurethane Architectural Elements

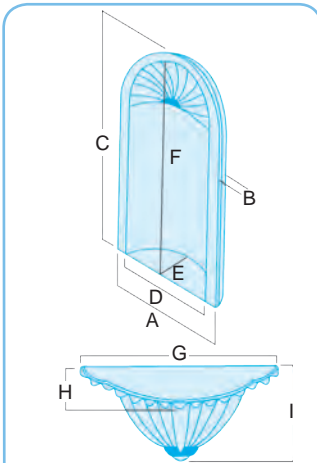

PART #	A	B	C	D	E	F	G	H	I
DEM-602	15-1/4"	5-3/8"	23-3/8"	11-3/16"	3-1/2"	22-3/4"	16-3/4"	3-7/8"	3-1/2"
DEM-605	23-1/2"	8"	43-1/4"	18"	6-1/8"	39"	26-3/8"	8"	9-1/4"
DEM-608	23-1/2"	8"	43-1/4"	18"	6-1/8"	39"	28"	4"	6-1/4"
DEM-611	35-1/4"	12"	63-5/8"	27-5/8"	11"	58"	37-1/2"	3-3/4"	5-3/8"



Please refrain from cutting the hole for your niche until you have actual niche for exact measurements.

SURFACE MOUNTED NICHE



No Cutting!
If You Can Hang a Picture, You Can Hang a Niche!

Surface Mounted Niche Dimension Chart

- No construction necessary.
- As simple as hanging a picture.
- Easily installed without having to cut a hole.
- Pre-attached keyhole hangers.

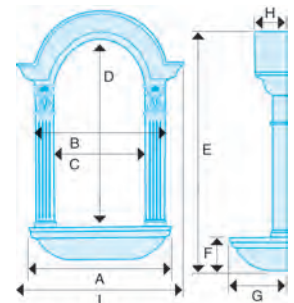

PART #	A	B	C	D	E	F	G	H	I
DEM-635	21-1/8"	19-1/4"	13-3/4"	28-5/8"	34"	2-1/2"	5-7/8"	4-3/8"	23-1/2"

All dimensions are approximate.

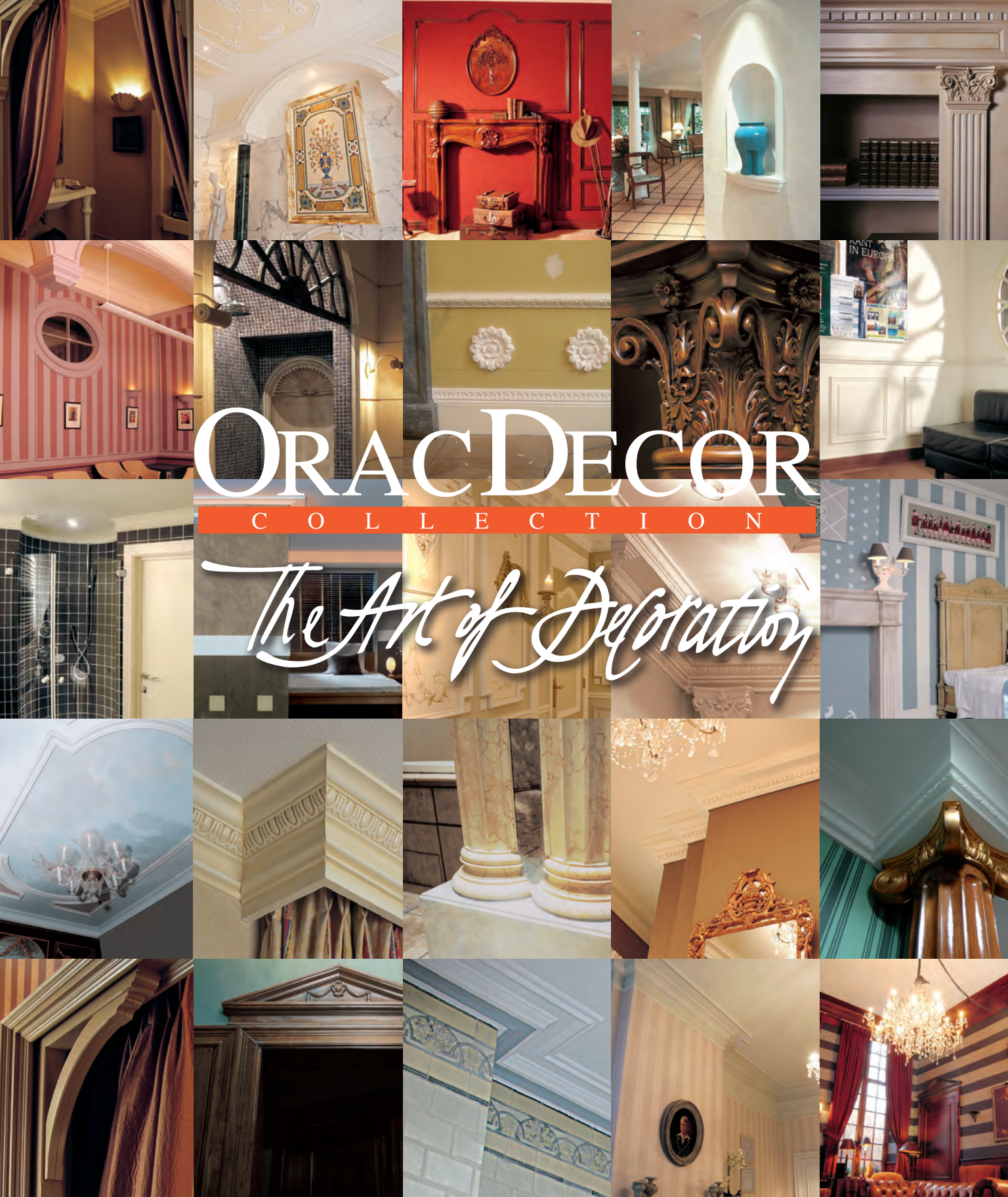

ORAC DECOR

C O L L E C T I O N

The Art of Decoration

The Art of Decoration

All the decorative elements in the ORAC DECOR Collection are produced in high density polyurethane, primed white. This material is extremely durable and easy to work with. It is tough, dimensionally stable, lightweight and easy to install using common woodworking tools and the Orac Decor adhesives. Adding elements from the ORAC DECOR Collection will enhance any new construction, renovation or redecoration project making a distinctive impression. The ORAC DECOR Collection offers a full range of decorative products reproduced from popular classic to contemporary designs.



Ceiling Medallions



Domes



Pediments



Flexible Mouldings

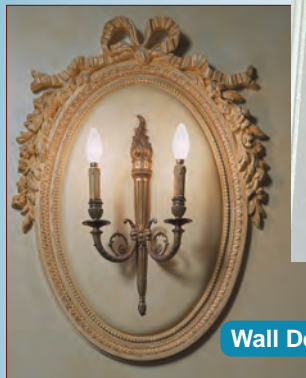

Wall Decorations



Wall Light Fixtures

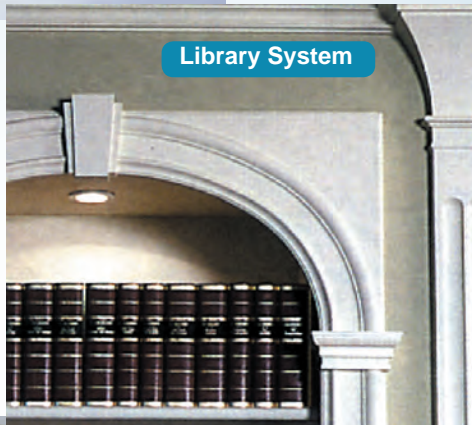

Library System



Cornice Mouldings



Panel Mouldings



Pilasters



Columns



Corbels



Niches



Wall Surrounds



Raised Panels



! WARRANTY: All products are guaranteed to be free from manufacturing defects for 1 year from date of purchase when properly installed. If defects are present, **warranty is limited to the replacement of defective material only.** Orac Decor/our company is not liable for any other costs incurred. **!**

PLAIN CORNICE MOULDINGS

“Europe’s #1 Choice for Interior Design”

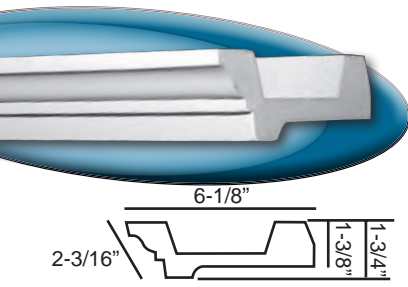

Bristol
C305 (rigid)

LENGTHS 6'6"
MEASUREMENTS ARE APPROXIMATE

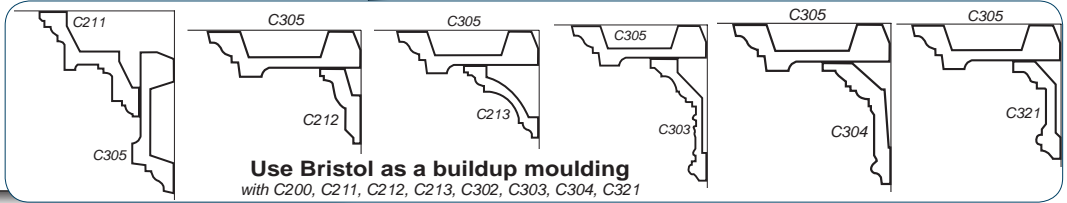

Use Bristol as a buildup moulding with C200, C211, C212, C213, C302, C303, C304, C321

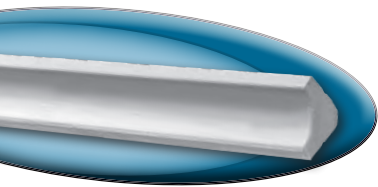

Hampshire
C250 (rigid)
FC250 (flexible**)

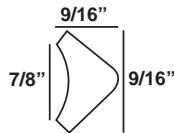

Windsor
C230 (rigid)
FC230 (flexible**)

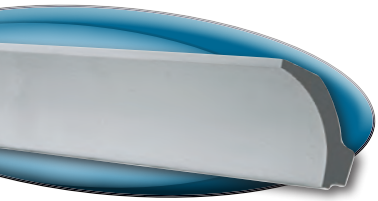
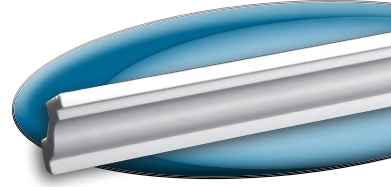
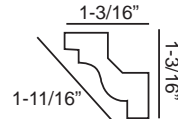

Art Nouveau
C260 (rigid)
FC260 (flexible**)



Small Traditional
C215 (rigid)
FC215 (flexible**)

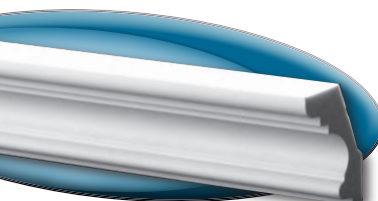
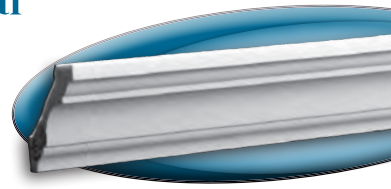
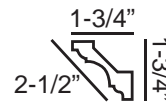

Federal
C322 (rigid)
FC322 (flexible**)



Small Contemporary
C602 (rigid)
FC602 (flexible**)

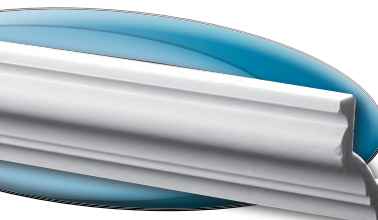
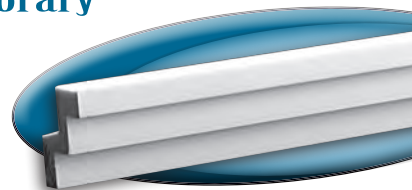
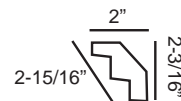

American
C200 (rigid)
FC200 (flexible**)



Camden
C321 (rigid)
FC321 (flexible**)

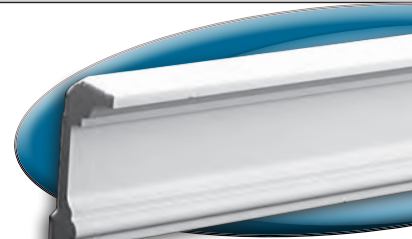
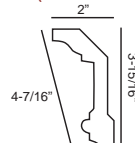

Product Notes: *Installations are guaranteed only when Orac Decor adhesives are used properly. Ordinary adhesives do not provide the strength needed to prevent joint separation.*

Check measurements at job site before installing. We are not responsible for deviations of measurements in the catalog. Certain elements within the Orac Decor Polyurethane line are now being produced from DUROPOLYMER®. These changes are noted where they pertain.



Most of our cornice mouldings can be obtained in flexible material (see page 832).

****Flexible Mouldings Have Limitations To Radius That Can Be Performed, See Page 832 For Important Information Regarding Flexible Applications.**



Use ORAC FIX Extra and ORAC DecoFix Pro for perfect installation (see page 849).

Ask For our **FREE** Orac color catalog. Individual Free Samples Available. **#A910**

PLAIN CORNICE MOULDINGS

“Europe’s #1 Choice for Interior Design”

LENGTHS 6'6"

MEASUREMENTS ARE APPROXIMATE

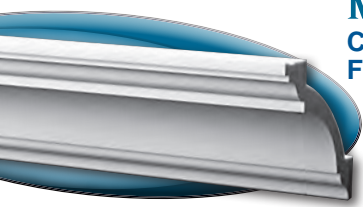

Medium Traditional

C213 (rigid)
FC213 (flexible**)

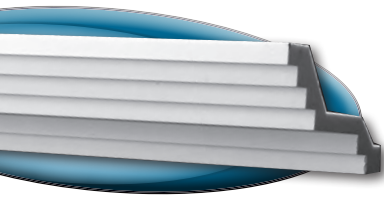
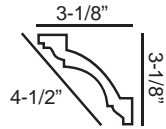

Sante Fe

C400 (rigid)

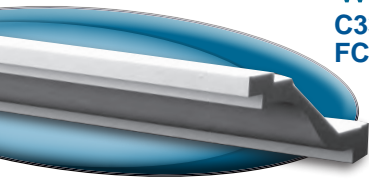
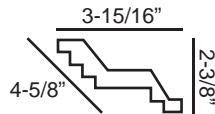

Weston

C331 (rigid)
FC331 (flexible**)

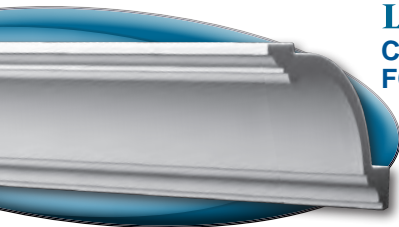

Large Traditional

C217 (rigid)
FC217 (flexible**)

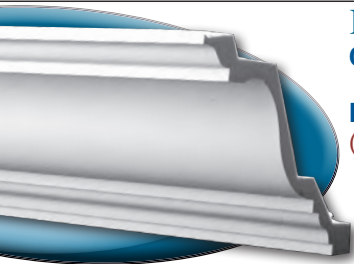
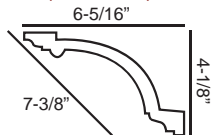

Fairfax

C334 (rigid)

FC334
(flexible**)

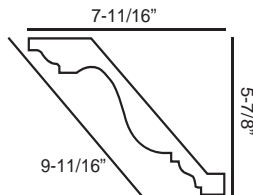

Small Cove

C240 (rigid)
FC240 (flexible**)

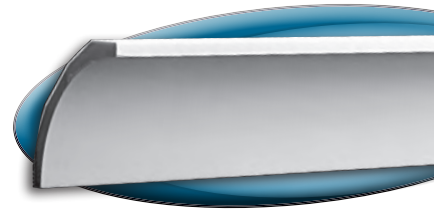
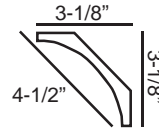

Wellington

C220 (rigid)
FC220 (flexible**)

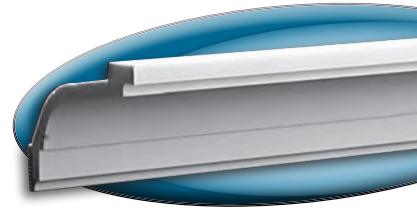
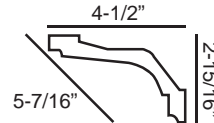

Monticello

C333 (rigid)

FC333 (flexible**)

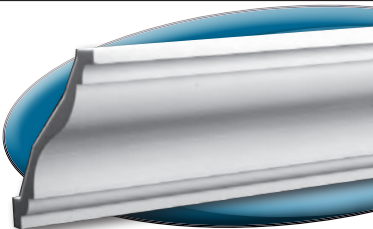
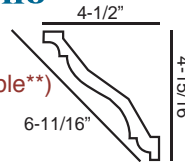

Large Contemporary

C300 (rigid)

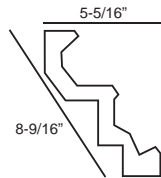

Avalon

C332 (rigid)

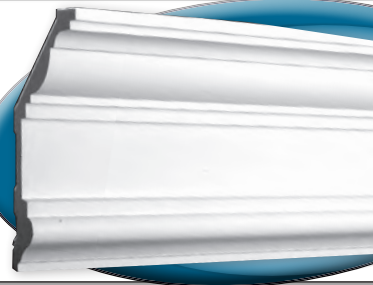
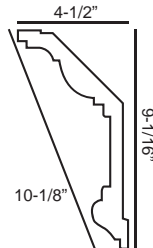

Product

Installations are guaranteed only when Orac Decor adhesives are used properly. Ordinary adhesives do not provide the strength needed to prevent joint separation.

Notes: Check measurements at job site before installing. We are not responsible for deviations of measurements in the catalog. Certain elements within the Orac Decor Polyurethane line are now being produced from DUROPOLYMER®. These changes are noted where they pertain.



Most of our cornice mouldings can be obtained in flexible material (see page 832).

****Flexible Mouldings Have Limitations To Radius That Can Be Performed, See Page 832 For Important Information Regarding Flexible Applications.**



Use ORAC FIX Extra and ORAC DecoFix Pro for perfect installation (see page 849).

Ask For our **FREE** Orac color catalog. Individual Free Samples Available. **#A910**

PLAIN CORNICE MOULDINGS

"Europe's #1 Choice for Interior Design"



LENGTHS 6'6" MEASUREMENTS ARE APPROXIMATE

Hamilton
C990 (rigid)

Carlisle
C335 (rigid)

Wiltshire
C336 (rigid)

* C990 can be used as a combination item with P9900 & P9901 (see pages 827)

FOR INDIRECT LIGHTING

Winston (for indirect lighting)
C900 (rigid)

Richmond (for indirect lighting)
C901 (rigid)
FC901 (flexible**)

Regency (for indirect lighting)
C902 (rigid)
FC902 (flexible**)



Product Notes: *Installations are guaranteed only when Orac Decor adhesives are used properly. Ordinary adhesives do not provide the strength needed to prevent joint separation.*

Check measurements at job site before installing. We are not responsible for deviations of measurements in the catalog. Certain elements within the Orac Decor Polyurethane line are now being produced from DUROPOLYMER®. These changes are noted where they pertain.



Most of our cornice mouldings can be obtained in flexible material (see page 832).

****Flexible Mouldings Have Limitations To Radius That Can Be Performed, See Page 832 For Important Information Regarding Flexible Applications.**

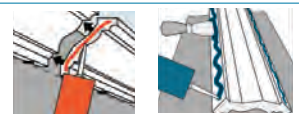

Use ORAC FIX Extra and ORAC DecoFix Pro for perfect installation (see page 849).

Ask For our **FREE** Orac color catalog. Individual Free Samples Available. **#A910**

DECORATIVE CORNICE MOULDINGS

"Europe's #1 Choice for Interior Design"

LENGTHS 6'6" MEASUREMENTS ARE APPROXIMATE

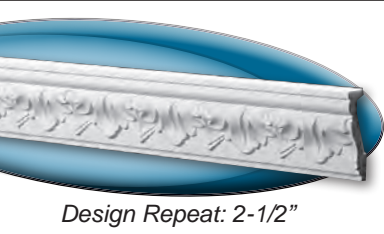

Small Classic

C214 (rigid)
FC214 (flexible**)

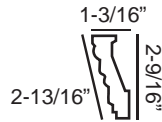

Design Repeat: 2-1/2"



Old English

C201 (rigid)
FC201 (flexible**)

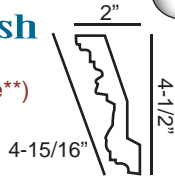

Design Repeat: 31-1/2"



Thatch

C402 (rigid)
FC402 (flexible**)

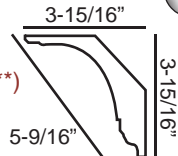

Design Repeat: 2-1/8"

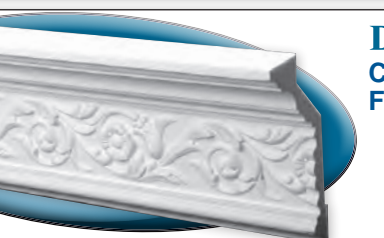

Delft

C303 (rigid)
FC303 (flexible**)

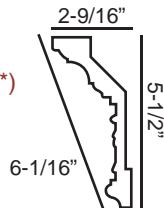

Design Repeat: 6-1/4"



Large Queen Anne

C216 (rigid)
FC216 (flexible**)

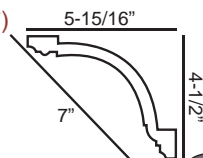

Design Repeat: 2"

Small Queen Anne

C212 (rigid)
FC212 (flexible**)

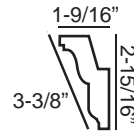

Design Repeat: 1-7/8"

Sheraton

C304 (rigid)
FC304 (flexible**)

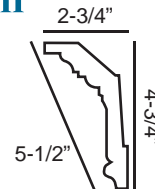

Design Repeat: 7/8"

Egg & Dart

C302 (rigid)
FC302 (flexible**)

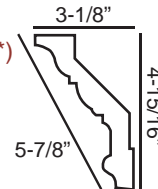

Design Repeat: 1-1/2"

Small Chippendale

C211 (rigid)
FC211 (flexible**)

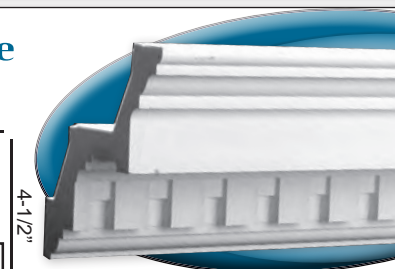

Design Repeat: 1-7/16"

Product Notes:

Installations are guaranteed only when Orac Decor adhesives are used properly. Ordinary adhesives do not provide the strength needed to prevent joint separation.

Check measurements at job site before installing. We are not responsible for deviations of measurements in the catalog. Certain elements within the Orac Decor Polyurethane line are now being produced from DUROPOLYMER®. These changes are noted where they pertain.

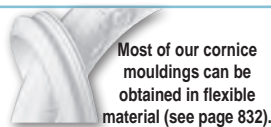

Most of our cornice mouldings can be obtained in flexible material (see page 832).

****Flexible Mouldings Have Limitations To Radius That Can Be Performed, See Page 832 For Important Information Regarding Flexible Applications.**



Use ORAC FIX Extra and ORAC DecoFix Pro for perfect installation (see page 849).

Ask for our **FREE** Orac color catalog. Individual Free Samples Available. **#A910**

DECORATIVE CORNICE MOULDINGS

"Europe's #1 Choice for Interior Design"

LENGTHS 6'6"

MEASUREMENTS ARE APPROXIMATE



DUROPOLYMER®



Hepplewhite

C218 (rigid)
FC218 (flexible**)

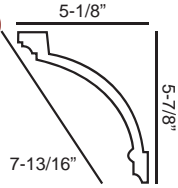

Design Repeat: 10-1/8"



Harbor Bay

C301 (rigid)
FC301 (flexible**)

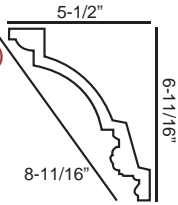

Design Repeat: 3-7/8"

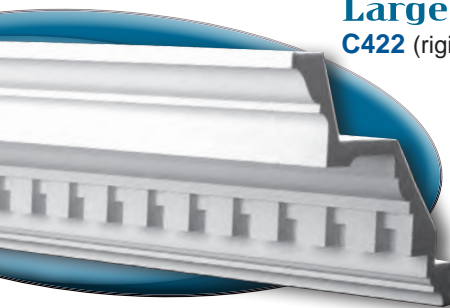

Large Chippendale

C422 (rigid)

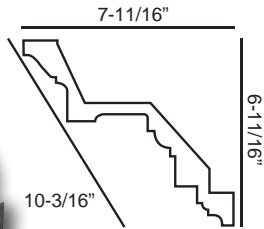

Design Repeat: 1-15/16"

Large Classic

C219 (rigid)

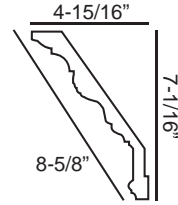

Design Repeat: 4"

Festoon

C308 (rigid)
FC308 (flexible**)



Design Repeat: 13-7/16"

Georgetown w/Corbels

C307 (rigid)
C-307A (Corbel)

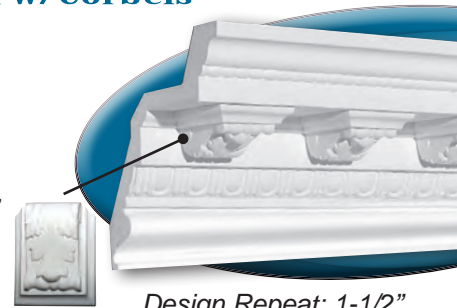
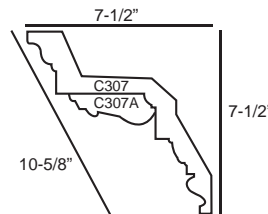

Design Repeat: 1-1/2"



For Product Information see page 828.

C307 with C-307A



PANEL MOULDINGS / ACCESSORIES

“Europe’s #1 Choice for Interior Design”

LENGTHS 6'6"

MEASUREMENTS ARE APPROXIMATE

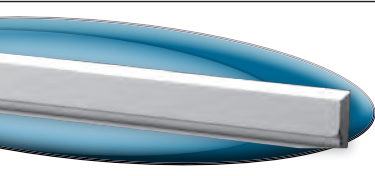

Sutton

P9050 (rigid)
FP9050 (flexible**)



Design Repeat: none

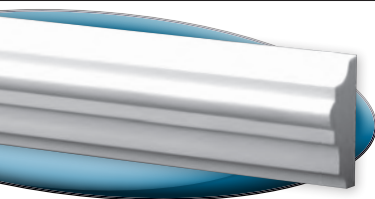

Essex

P9040 (rigid)
FP9040 (flexible**)



Design Repeat: none

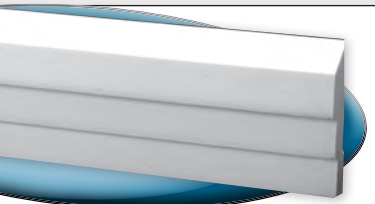

Contemporary

P7070 (rigid)
FP7070 (flexible**)

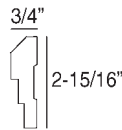

Design Repeat: none

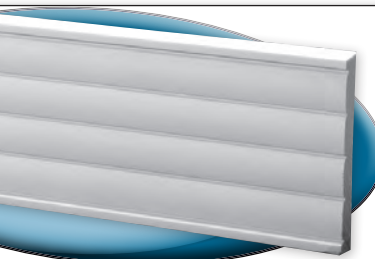

Weave

P5020 (rigid)
FP5020 (flexible**)

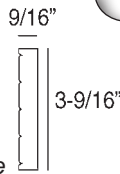

Design Repeat: none

P-5020A
P-5020B



P-5020A
3-9/16"x
3-9/16"x
1/2"

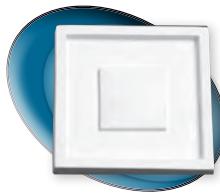

P-5020B
3-9/16"x
3-9/16"x
1/2"

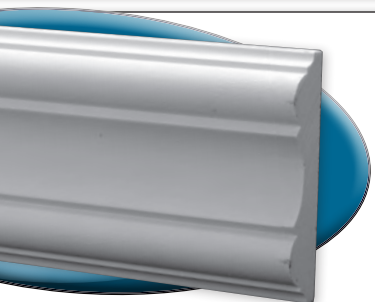

Chesterfield

P8040 (rigid)
FP8040 (flexible**)

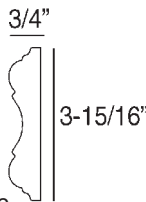

Design Repeat: none

Small Weave

P5021 (rigid)
FP5021 (flexible**)

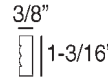

Design Repeat: none

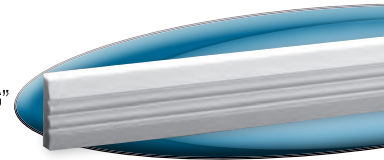

Providence

P9901 (rigid)
FP9901 (flexible**)



Design Repeat: none

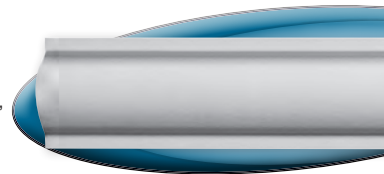

Brunswick

P9900 (rigid)
FP9900 (flexible**)

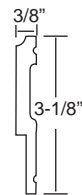

Design Repeat: none

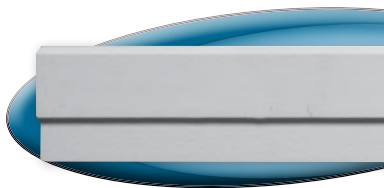

Chatham

P9020 (rigid)
FP9020 (flexible**)

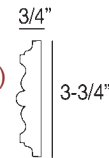

Design Repeat: none

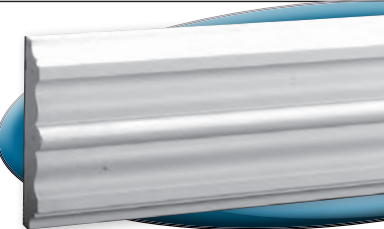

Hampton

P9010 (rigid)
FP9010 (flexible**)

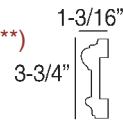

Design Repeat: none

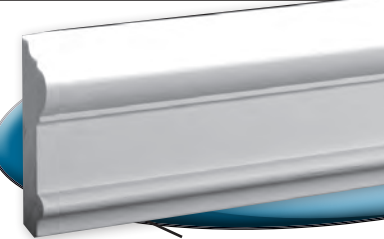

Yorkshire

P8050 (rigid)
FP8050 (flexible**)

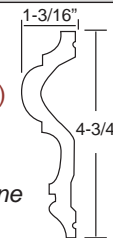

Design Repeat: none

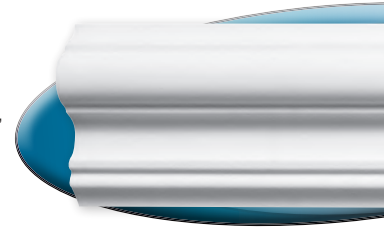

Product Notes: Installations are guaranteed only when Orac Decor adhesives are used properly. Ordinary adhesives do not provide the strength needed to prevent joint separation.

“Europe’s #1 Choice for Interior Design”

LENGTHS 6’6” MEASUREMENTS ARE APPROXIMATE

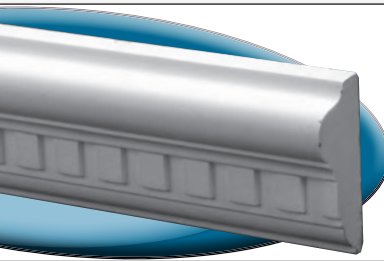

Chippendale

P6020 (rigid)
FP6020 (flexible**)

Design Repeat: 3/4"

1-3/16"

2-9/16"



Classic

P3020 (rigid)
FP3020 (flexible**)

Design Repeat: 3-1/8"

1-3/16"

2-3/8"



Harbor Bay

P7050 (rigid)
FP7050 (flexible**)

Design Repeat: 3-1/8"

2-3/8"

1"



Greek Key

P7060 (rigid)
FP7060 (flexible**)

Design Repeat: 2-1/2"

2-3/4"

3/4"

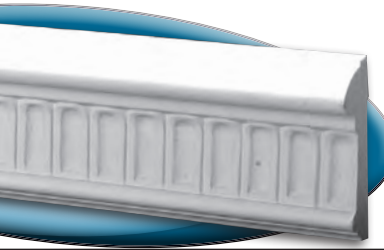
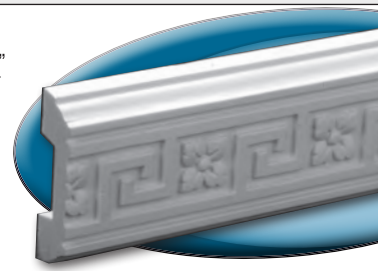

Sheraton

P7040 (rigid)
FP7040 (flexible**)

Design Repeat: 7/8"

3-1/8"

1"



Queen Anne

P7030 (rigid)
FP7030 (flexible**)

Design Repeat: 1-1/2"

3-3/8"

9/16"



Victorian Braid

P7010 (rigid)
FP7010 (flexible**)

Design Repeat: 9-13/16"

4-1/8"

3/4"



Delft

P7020 (rigid)
FP7020 (flexible**)

Design Repeat: 6-1/4"

4-3/8"

3/4"



Ellington

P7080 (rigid)

Design Repeat: 15-3/4"

8-5/8"

3/4"



Product Notes:

Installations are guaranteed only when Orac Decor adhesives are used properly. Ordinary adhesives do not provide the strength needed to prevent joint separation.

Check measurements at job site before installing. We are not responsible for deviations of measurements in the catalog. Certain elements within the Orac Decor Polyurethane line are now being produced from DUROPOLYMER®. These changes are noted where they pertain.



Most of our cornice mouldings can be obtained in flexible material (see page 832).

****Flexible Mouldings Have Limitations To Radius That Can Be Performed, See Page 832 For Important Information Regarding Flexible Applications.**

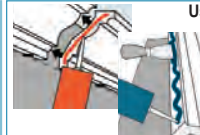

Use ORAC FIX Extra and ORAC DecoFix Pro for perfect installation (see page 849).



Europe's # 1 Choice for Interior Design



P-801C

P8020



Endless Possibilities

“Europe’s #1 Choice for Interior Design”

LENGTHS 6’6”

MEASUREMENTS ARE APPROXIMATE



*DUROPOLYMER®

Small Americanna

P8030 (rigid)
FP8030 (flexible**)

Design Repeat: none

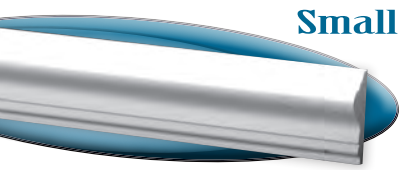

***P8030D**

5-1/8"x
5-1/8"x9/16"

9/16"
1-9/16"



All Curves have an Inside Radius approximately 5"

***P-8030C**

7-1/2"x
3-9/16"x9/16"

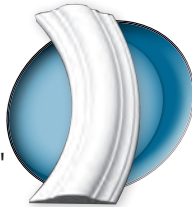

P1020,
P8030



P2020
P-201A
P-21

Wellington

P4020 (rigid)
FP4020 (flexible**)

Design Repeat: none

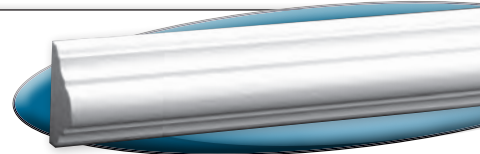

P-4020A

All Curves have an Inside Radius approximately 5"

***P-4020A**

6-9/16" x
2" x 1-3/16"

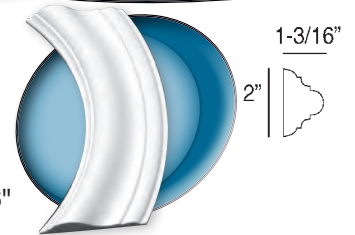

Victorian

P1020 (rigid)
FP1020 (flexible**)

Design Repeat: 2-3/8"

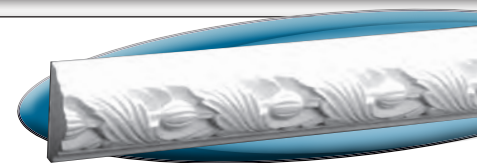

P-20
P-101A

P-20
2-9/16"Dx1/2"

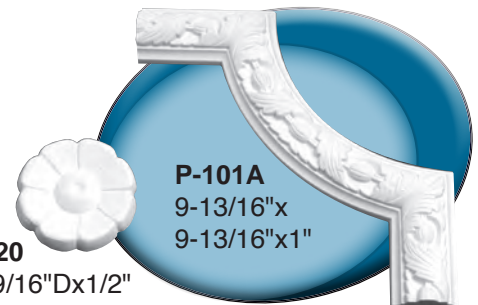

P-101A
9-13/16"x
9-13/16"x1"

Large Americanna

P8020 (rigid)
FP8020 (flexible**)

Design Repeat: none

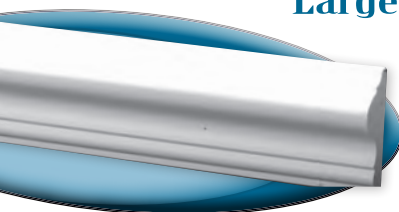

P-801C

1"
2-3/8"

All Curves have an Inside Radius approximately 5"

***P-801C**

7-7/8"x
4-3/8"x1"

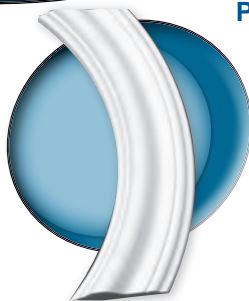

American Colonial

P2020 (rigid)

FP2020 (flexible**)

Design Repeat: 3-1/2"



P-21
P-201A

P-21
2-9/16"x
2-9/16"x1/2"

1"
1-3/4"



P-201A
9-13/16"x
9-13/16"x1"

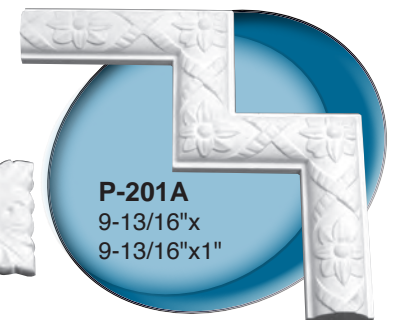

NICHES

“Europe’s #1 Choice for Interior Design”



MEASUREMENTS
ARE APPROXIMATE



N503,
N510



N504, N510



Note: Please refrain from cutting the hole for your niche until you have the actual niche for exact measurements.

All 400 & 500 series niches come with a translucent shelf for uplighting - (LIGHT & HARDWARE NOT INCLUDED).

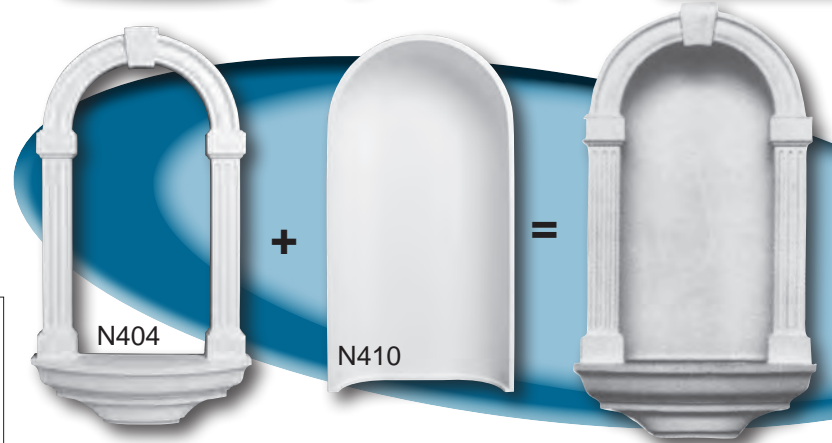
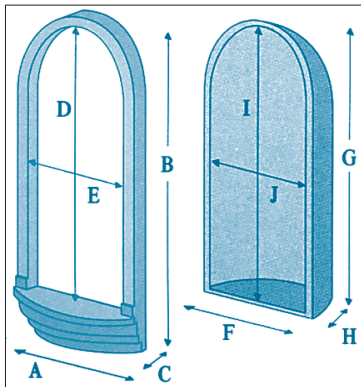

N404, N410

PART #	A	B	C	D	E
N404	16-9/16"	29-15/16"	4-3/8"	21-5/8"	9-5/8"
N503	27-3/8"	44-11/16"	4-3/8"	37-3/16"	20-1/4"
N504	27-3/8"	44-7/8"	4-3/8"	37-3/16"	19-1/2"
PART #	F	G	H	I	J
N410	12-3/8"	23-5/8"	3-3/8"	23-1/16"	11"
N510	22-1/16"	38-3/4"	7-1/16"	37-13/16"	20-7/8"
N520	22-1/16"	38-9/16"	7-1/16"	36-1/4"	20-7/8"

? Did You Know... Ask For our **FREE** Orac color catalog. Individual **FREE** Samples Available. **#A910**

No CFCs
ORAC DECOR
World's #1 choice for

BUILDING GREEN

FLEXIBLE MOULDINGS

“Europe’s #1 Choice for Interior Design”



Our “Bend To Fit”, straight flex is stocked in 6’6” lengths ready for immediate shipping.

This lightweight polymer is capable of moderate radii (see chart below) to suit most applications.

FC & FP Series = Available in Straight 6’6” Lengths
SX Series = Available in Straight 8’ Lengths

NOT RECOMMENDED FOR INDIRECT LIGHTING APPLICATIONS

“BEND TO FIT”

PART #	MIN. INSIDE RADIUS	MIN. OUTSIDE RADIUS	MIN. ARCH RADIUS
FLEXIBLE CORNICE MOULDINGS			
FC200	5’	5’	N/A
FC201	4’6”	4’6”	N/A
FC211	10’6”	10’6”	N/A
FC212	4’6”	4’6”	N/A
FC213	7’6”	7’6”	N/A
FC214	3’6”	3’6”	N/A
FC215	5’6”	5’6”	N/A
FC216	11’	11’	N/A
FC217	11’	11’	N/A
FC218	12’	12’	N/A
FC220	9’6”	9’6”	N/A
FC230	3’6”	3’6”	N/A
FC240	7’6”	7’6”	N/A
FC250	3’6”	3’6”	N/A
FC260	5’	5’	N/A
FC301	9’6”	9’6”	N/A
FC302	6’6”	6’6”	N/A
FC303	6’	6’	N/A
FC304	5’6”	5’6”	N/A
FC308	4’6”	4’6”	N/A
FC321	4’6”	4’6”	N/A
FC322	4’	4’	N/A
FC331	15’	15’	6’
FC333	12’	12’	N/A
FC334	13’6”	13’6”	N/A
FC402	6’	6’	N/A
FC602	4’6”	4’6”	6’
FC901	12’	12’	N/A
FC902	13’	13’	N/A

“BEND TO FIT”

PART #	MIN. INSIDE RADIUS	MIN. OUTSIDE RADIUS	MIN. ARCH RADIUS
FLEXIBLE PANEL MOULDINGS			
FP1020	1’	1’	2’6”
FP2020	1’	1’	2’6”
FP3020	3’	3”	6’
FP4020	3’	3’	3’
FP5020	1’6”	1’6”	9’
FP5021	1’	1’	2’6”
FP6020	1’6”	1’6”	5’
FP7010	1’	1’	10’
FP7020	1’	1’	9’6”
FP7030	1’	1’	5’
FP7040	1’6”	1’6”	6’
FP7050	1’6”	1’6”	5’
FP7060	5”	5”	6’
FP7070	1’6”	1’6”	9’
FP8020	1’6”	1’6”	4’6”
FP8030	1’	1’	2’
FP8040	1’	1’	9’6”
FP8050	1’	1’	9’
FP8060	1’	1’	10’
FP9010	1’6”	1’6”	8’6”
FP9020	1’6”	1’6”	9’
FP9040	1’6”	1’6”	3’
FP9050	1’	1’	2’6”
FP9900	1’6”	1’6”	6’
FP9901	1’6”	1’6”	6’
FLEXIBLE BASE MOULDINGS			
SX105F	1’6”	1’6”	N/A
SX118F	1’6”	1’6”	N/A
SX155F	1’6”	1’6”	N/A



Inside Radius



Outside Radius

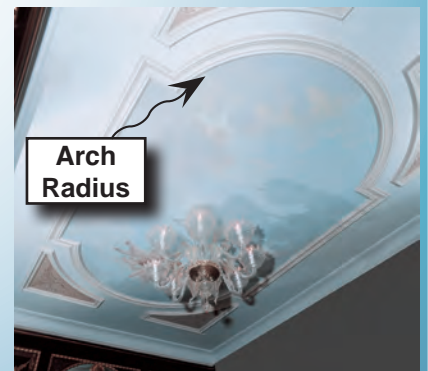

Arch Radius

Above radii are the tightest curves capable without deformation of profile and excessive stress on mounting surfaces. Our company assumes no responsibility for material when recommended radii is exceeded. It is best to paint mouldings after installation. See flexible installation page for proper installation procedures.

NOTE: Flexible mouldings may vary slightly in size (more on larger profiles) compared to rigid straight mouldings.



Ask For our **FREE** Orac color catalog. **#A910**
Individual **FREE** Samples Available.



PILASTERS

"Europe's #1 Choice for Interior Design"

MEASUREMENTS ARE APPROXIMATE



D210
3 3/4"W
x 3 3/4"H
x 1-3/8"D

P9020
6'6"H

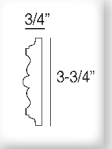

D310
3 3/4"W x
9-13/16"H
x 1-3/16"D



K201
5-7/8"H

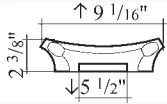

K200
6'6"H

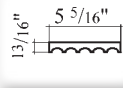

K202
21-1/4"H

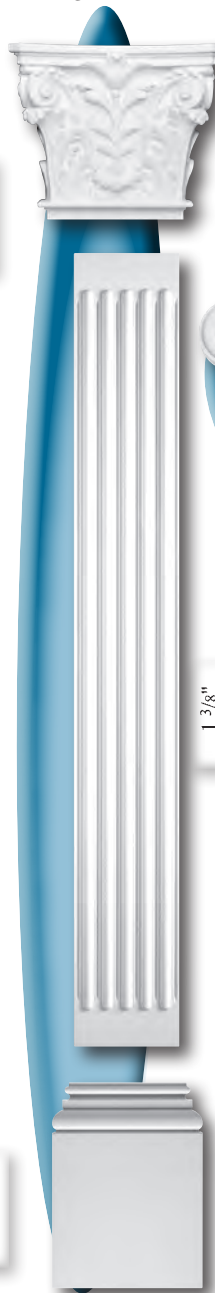
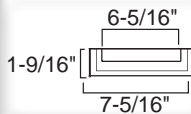

K251
14"H

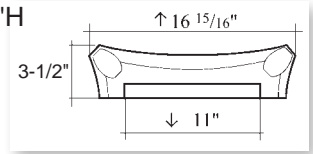

K250
6'6"H

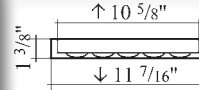

K254
20-7/8" H

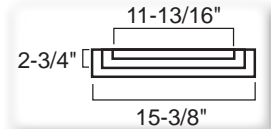

K253
5-5/16" H

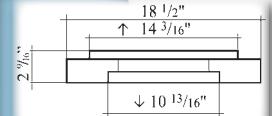

(Use with the
K250 & K254)



D120,
K201,
K200

Don't Forget...
Use ORAC FIX
Extra and ORAC
DecoFix Pro for
perfect installation
(see page 849).



? Did You Know...

Ask For our FREE Orac color catalog. **#A910**
Individual FREE Samples Available.



Check measurements at job site before installing. We are not responsible for deviations of measurements in the catalog.

PILASTERS

"Europe's #1 Choice for Interior Design"



MEASUREMENTS ARE APPROXIMATE



K241
7-1/16" H

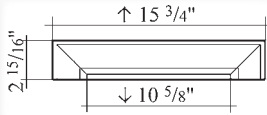

K240
6'6" H

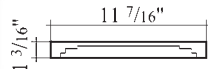

K254
20-7/8" H

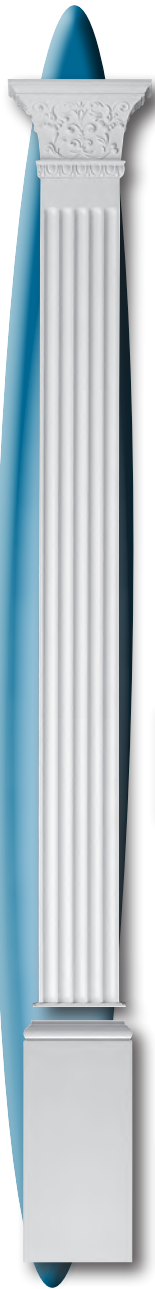
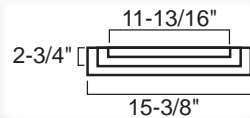

K221
8-11/16" H

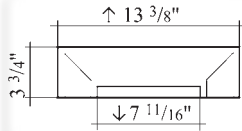

K220
6'6" H

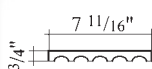

K255
21-1/4" H

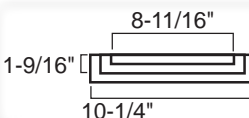

K223
8-7/8" H

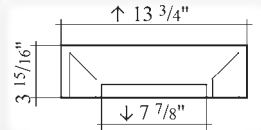

(Use with the K220 & K255)



K223,
K220



K221,
K220

Don't Forget...
Use ORAC FIX Extra and ORAC DecoFix Pro for perfect installation (see page 849).



? Did You Know...

Ask For our FREE Orac color catalog. Individual FREE Samples Available. **#A910**



Check measurements at job site before installing. We are not responsible for deviations of measurements in the catalog.

CONTEMPORARY HALF COLUMNS

"Europe's #1 Choice for Interior Design"

MEASUREMENTS ARE APPROXIMATE



***DUROPOLYMER®**

Mix & Match!

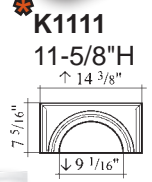
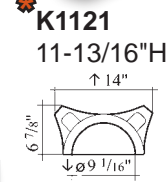
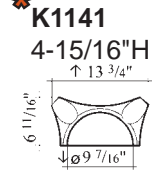
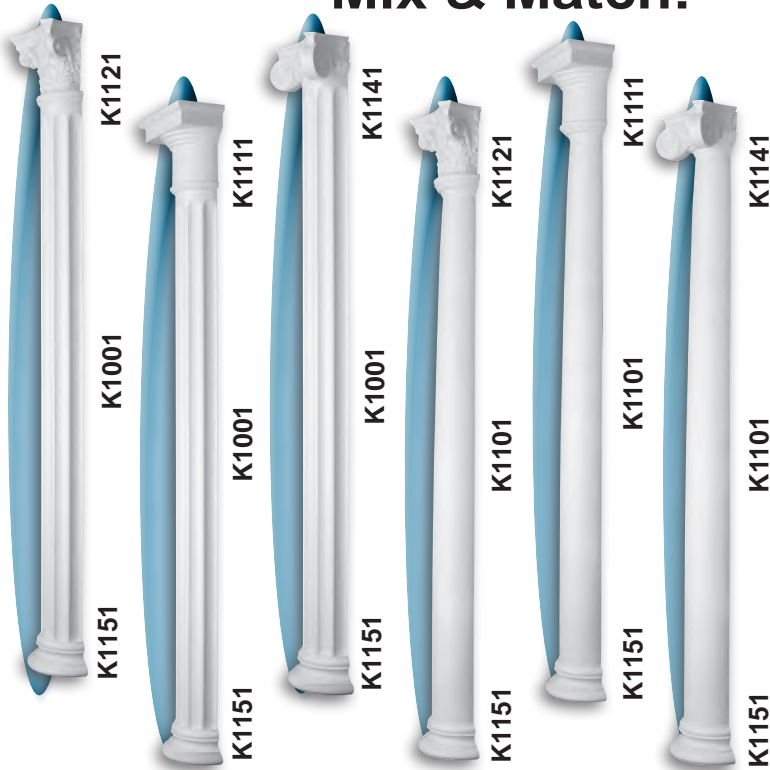

K1001
6'6" H

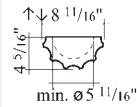

K1101
6'6" H

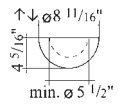

DO NOT CUT COLUMNS.
All height adjustments are to be made by cutting plinth base.

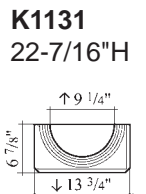

? Did You Know...
Ask For our **FREE** Orac color catalog.
Individual **FREE** Samples Available.
#A910

CLASSICAL HALF COLUMNS

"Europe's #1 Choice for Interior Design"

MEASUREMENTS ARE APPROXIMATE



***DUROPOLYMER®**

Mix & Match!

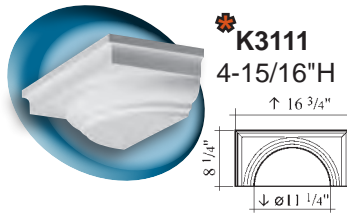
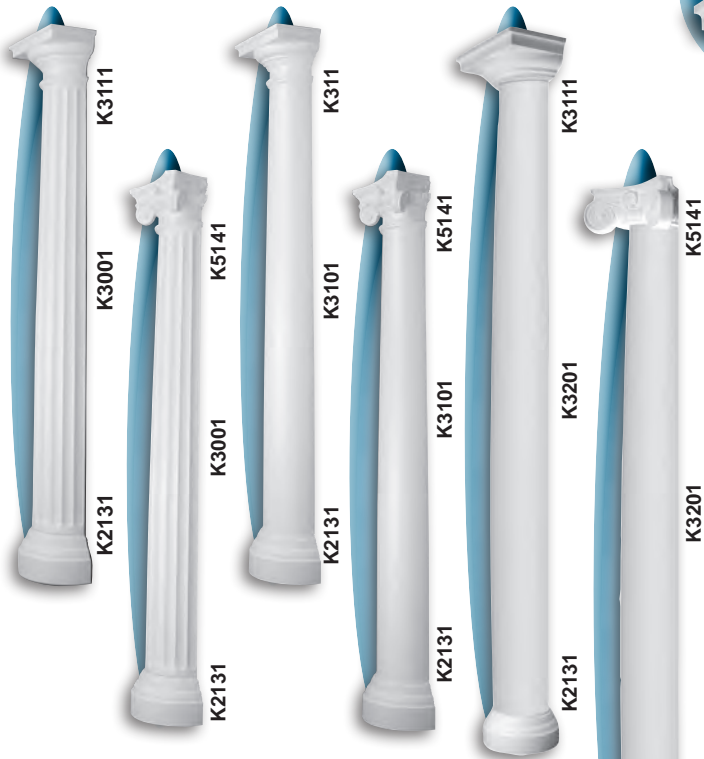

K3001
6'6" H

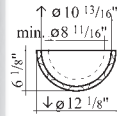

K3101
6'6" H

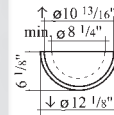

Can achieve overall height of approximately 10'-3-1/4" if used with K3151 & K5141

K3201
7'10-1/2" H

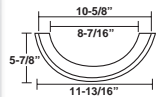

**K1102,
K1152**

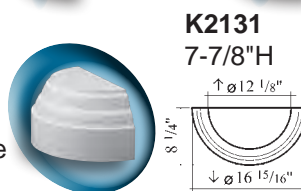

K2131
7-7/8" H



K3151
22-5/8" H

DO NOT CUT COLUMNS.
All height adjustments are to be made by cutting plinth base.

? Did You Know...

Ask For our **FREE** Orac color catalog.
Individual **FREE** Samples Available.

#A910



CONTEMPORARY WHOLE COLUMNS

"Europe's #1 Choice for Interior Design"

MEASUREMENTS ARE APPROXIMATE



***DUROPOLYMER®**

Mix & Match!

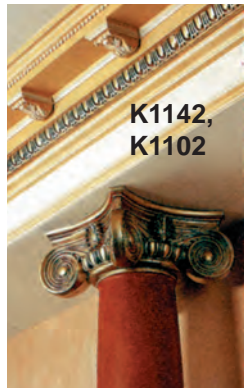
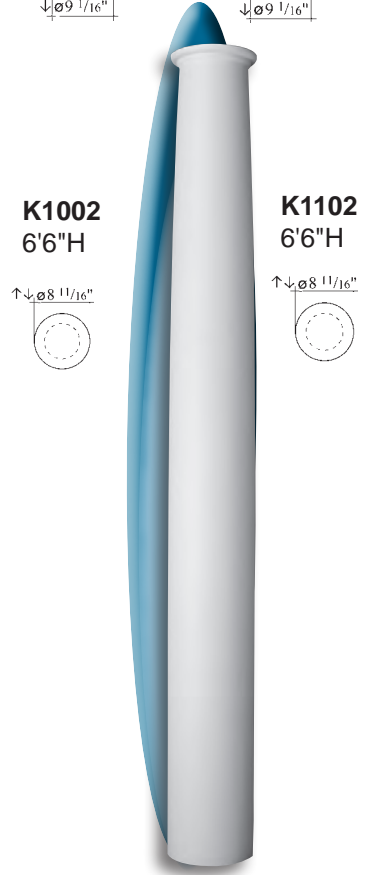
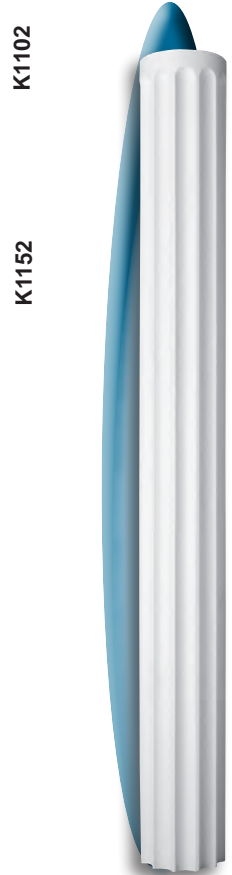
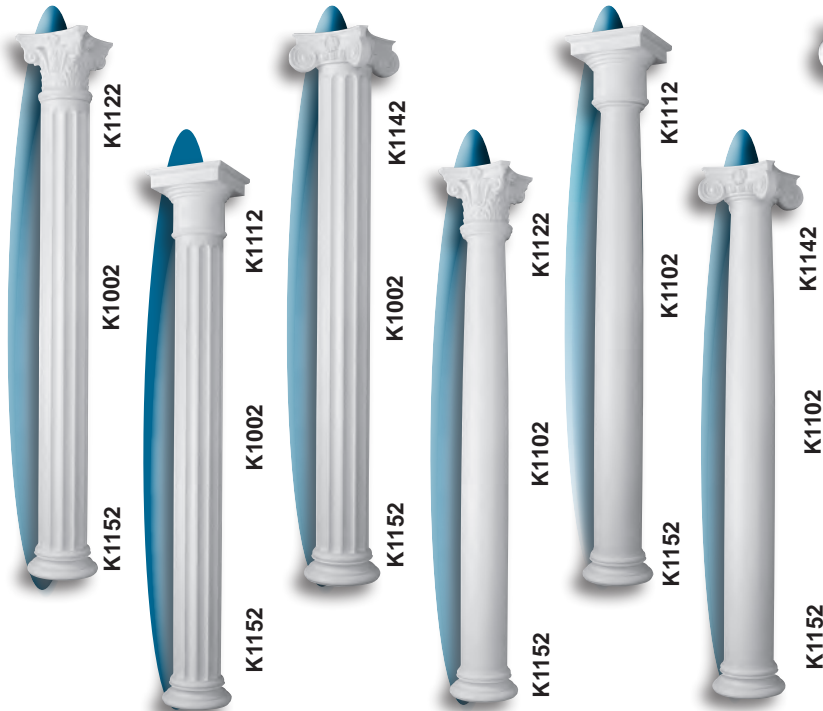

? Did You Know...

Ask for our **FREE** Orac color catalog.
Individual **FREE** Samples Available.

#A910



DO NOT CUT COLUMNS.
All height adjustments are to be made by cutting plinth base.

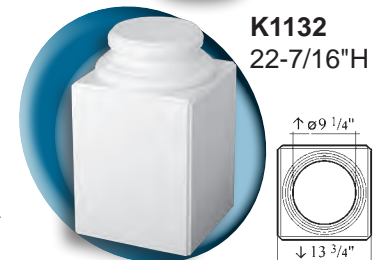

"Europe's #1 Choice for Interior Design"

MEASUREMENTS ARE APPROXIMATE



***DUROPOLYMER®**

Mix & Match!

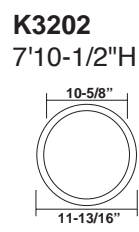
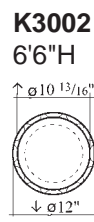
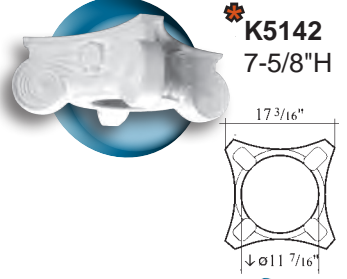
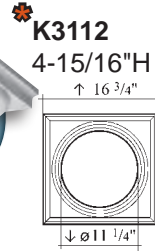
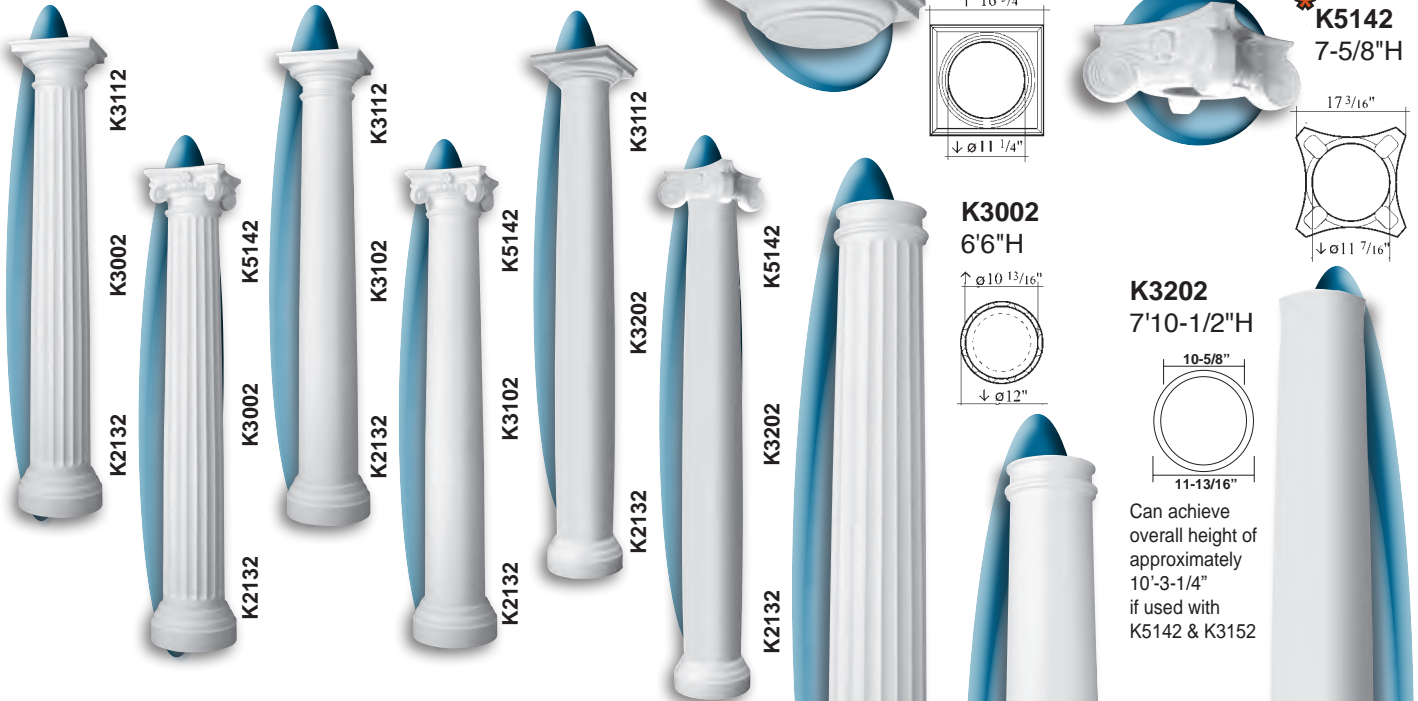

Can achieve overall height of approximately 10'-3-1/4" if used with K5142 & K3152

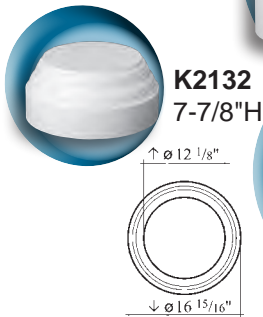
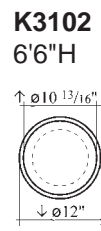

DO NOT CUT COLUMNS.
All height adjustments are to be made by cutting plinth base.

? Did You Know...
Ask For our **FREE** Orac color catalog.
Individual **FREE** Samples Available.
#A910
No CFCs
ORAC DECOR BUILDING GREEN
World's Choice for

Europe's # 1 Choice for Interior Design



LIBRARY FACADE SYSTEM

"Europe's #1 Choice for Interior Design"



MEASUREMENTS ARE APPROXIMATE

***DUROPOLYMER®**

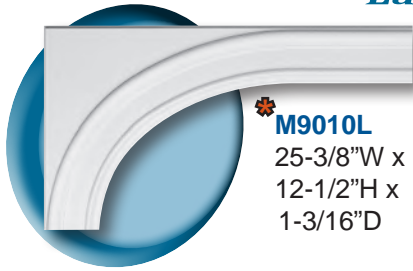

M9010L
25-3/8"W x
12-1/2"H x
1-3/16"D

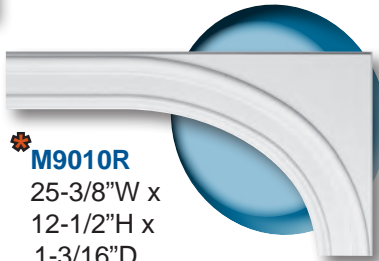

M9010R
25-3/8"W x
12-1/2"H x
1-3/16"D



M9010A
3-5/16"W x 4-1/2"H x 1-3/4"D



M9010B
4-15/16"W x
1-15/16"H x 1-15/16"D



M9010C
8-7/8"W x
1-15/16"H x 1-15/16"D

P9010
3-9/16"W x
6'6"H x 1-3/16"D

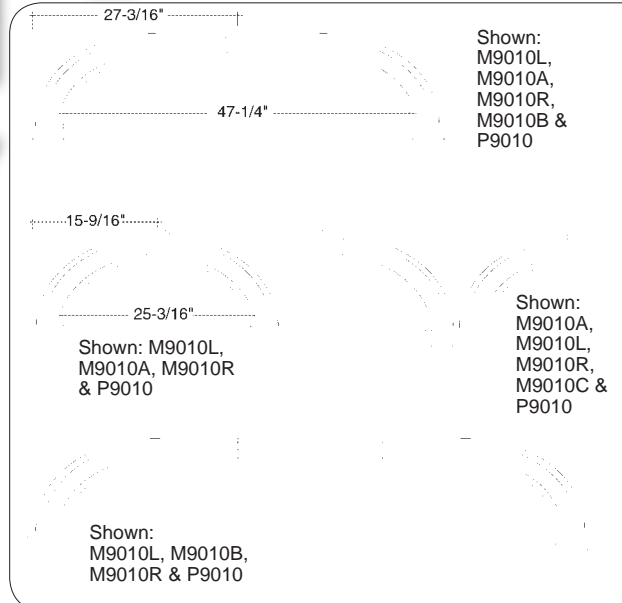
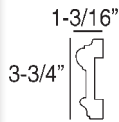

DECORATIVE DOOR SURROUNDS

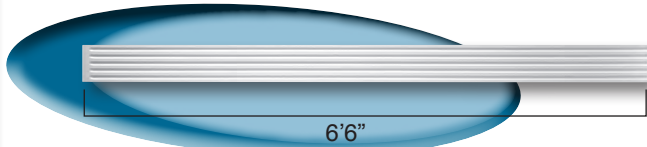

K200

6'6"

5-3/8"

[3/4"]

K201L/R



1" 5-3/8"

D300
3-3/4"W x 10-1/4"H
x 1-9/16"D

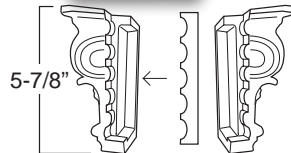

5-7/8"

9-7/8"



5-3/8"

D320

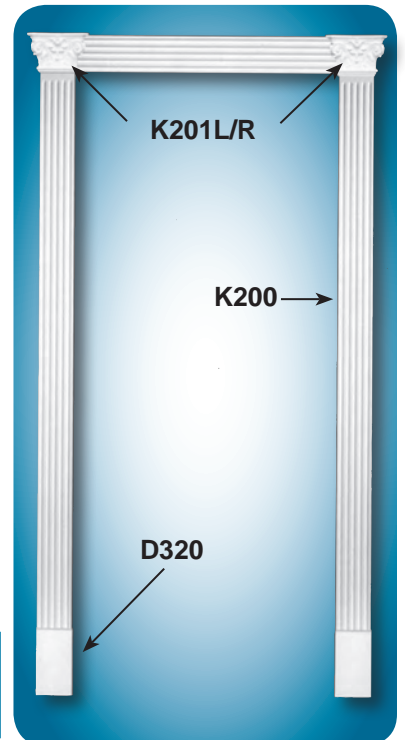

? Did You Know...

Ask For our **FREE** Orac color catalog. **#A910**
Individual **FREE** Samples Available.



CEILING MEDALLIONS

“Europe’s #1 Choice for Interior Design”

MEASUREMENTS ARE APPROXIMATE

Our medallions are specially designed with a solid core for ornamental plaque use. However, all medallions can be cut with a hole cutter or keyhole saw to accommodate lighting or ceiling fans.



R-10
5-7/8" DIA.



R-11
7-1/4" DIA.



R-12
7-11/16" DIA.



R-35
8-5/8" DIA.

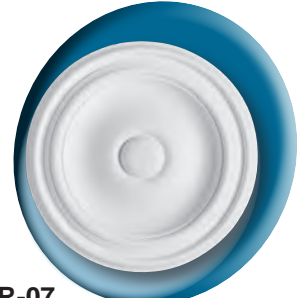

R-07
10-1/4" DIA.



R-13
11-1/4" DIA.



R-50
12-5/8" DIA.



R-14
13-3/16" DIA.



R-08
14-15/16" DIA.



R-31
15-3/16" DIA.



R-61
15-3/4" DIA.



R-12

SEE PAGE 775
FOR OUR
CHANDELIER LIGHT LIFT

Don't Forget...
Use ORAC FIX Extra and ORAC DecoFix Pro for perfect installation (see page 849).



? Did You Know...

Ask For our **FREE** Orac color catalog. **#A910**
Individual **FREE** Samples Available.



Check measurements at job site before installing. We are not responsible for deviations of measurements in the catalog.

CEILING MEDALLIONS

“Europe’s #1 Choice for Interior Design”



MEASUREMENTS ARE APPROXIMATE

Our medallions are specially designed with a solid core for ornamental plaque use. However, all medallions can be cut with a hole cutter or keyhole saw to accommodate lighting or ceiling fans.



R-51
16-9/16" DIA.



R-16
17-11/16" DIA.



R-18



R-17
18-5/16" DIA.

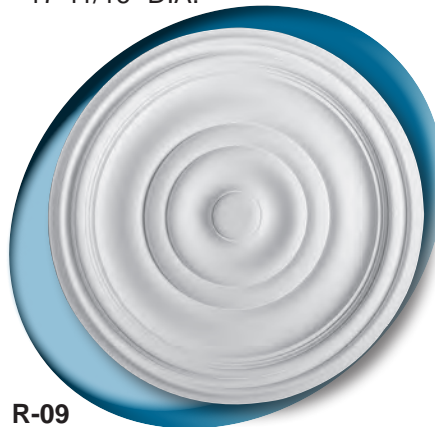

R-09
19-1/8" DIA.



R-18
19-1/8" DIA.



R-46
20-7/8" DIA.

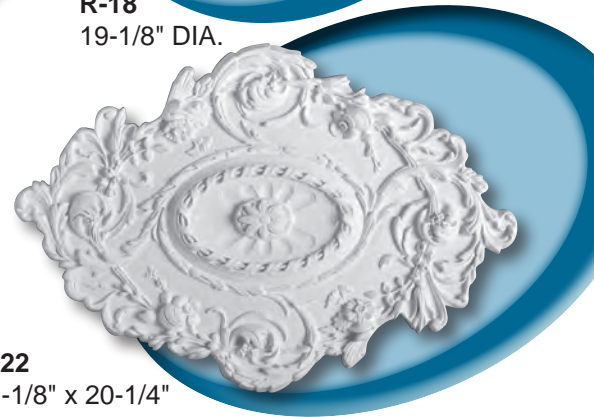

R-22
31-1/8" x 20-1/4"

SEE PAGE 775
FOR OUR
CHANDELIER LIGHT LIFT

Don't Forget...
Use ORAC FIX Extra and ORAC DecoFix Pro for perfect installation (see page 849).



? Did You Know...

Ask for our FREE Orac color catalog. **#A910**
Individual FREE Samples Available.



Check measurements at job site before installing. We are not responsible for deviations of measurements in the catalog.

CEILING MEDALLIONS

“Europe’s #1 Choice for Interior Design”



MEASUREMENTS ARE APPROXIMATE

Our medallions are specially designed with a solid core for ornamental plaque use. However, all medallions can be cut with a hole cutter or keyhole saw to accommodate lighting or ceiling fans.



R-66
21-7/16" O.D.
16-15/16" I.D.



R-76
24-3/8" DIA.



R-77
24-3/8" DIA.



R-74
25-7/8" DIA.

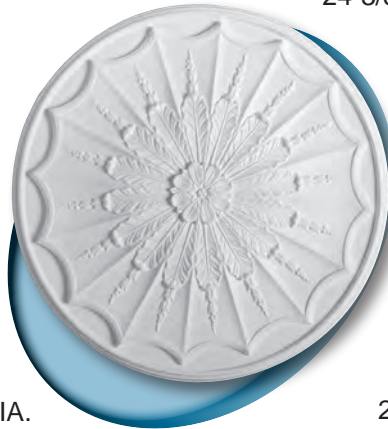

R-28
26-15/16" DIA.



R-52
27-1/2" DIA.

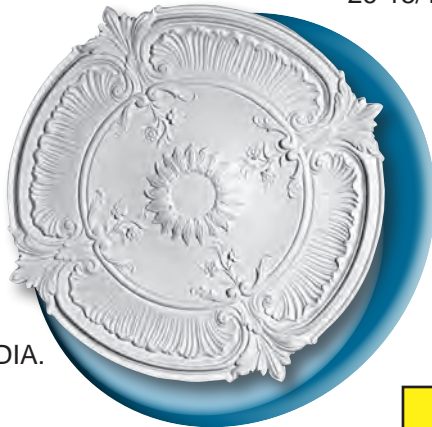

R-73
27-5/8" DIA.



R-23
28-1/8" DIA.



R-40

SEE PAGE 775
FOR OUR
CHANDELIER LIGHT LIFT

Don't Forget...
Use ORAC FIX Extra
and ORAC DecoFix Pro
for perfect installation
(see page 849).



? Did You Know...

Ask For our FREE Orac color catalog. **#A910**
Individual FREE Samples Available.



Check measurements at job site before installing. We are not responsible for deviations of measurements in the catalog.

CEILING MEDALLIONS

“Europe’s #1 Choice for Interior Design”



MEASUREMENTS ARE APPROXIMATE

Our medallions are specially designed with a solid core for ornamental plaque use. However, all medallions can be cut with a hole cutter or keyhole saw to accommodate lighting or ceiling fans.



R-24
30-7/8" DIA.



R-38
28-1/8" DIA.

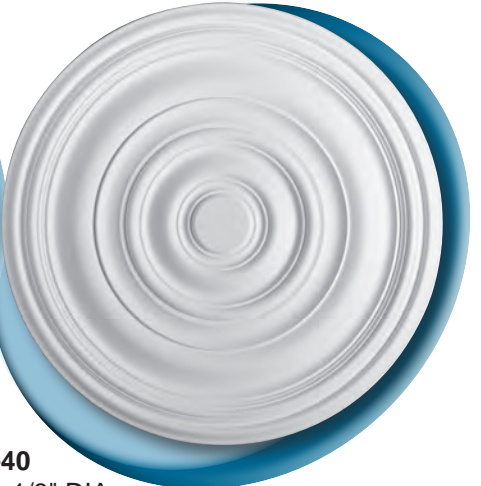

R-40
29-1/8" DIA.



R-27
29-1/2" DIA.



R-38



R-64
37-3/8" DIA.

SEE PAGE 775
FOR OUR
CHANDELIER LIGHT LIFT

Don't Forget...
Use ORAC FIX Extra
and ORAC DecoFix Pro
for perfect installation
(see page 849).



? Did You Know...

Ask For our FREE Orac color catalog.
Individual FREE Samples Available. **#A910**



Check measurements at job site before installing. We are not responsible for deviations of measurements in the catalog.

WALL DECORATIONS & SHELVES

"Europe's #1 Choice for Interior Design"



***DUROPOLYMER®**

MEASUREMENTS ARE APPROXIMATE

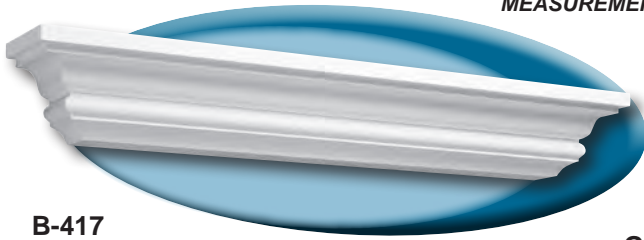

B-417
35-5/8" W x 4-15/16" H
x 5-1/2" D

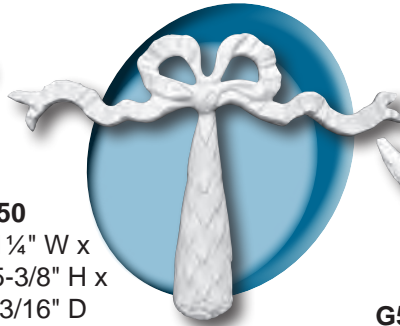

G50
21 1/4" W x
15-3/8" H x
1-3/16" D

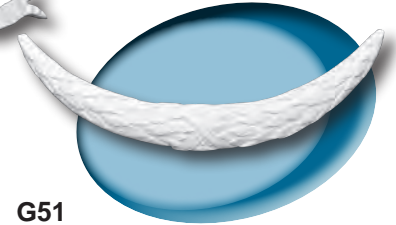

G51
28 3/4" W x 9-7/16" H x 1-3/16" D

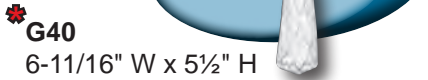

***G40**
6-11/16" W x 5 1/2" H
x 5/8" D - 3/4" at neck



***G42**
16-1/8" W x 2" H x 5/8" D



PEDIMENTS

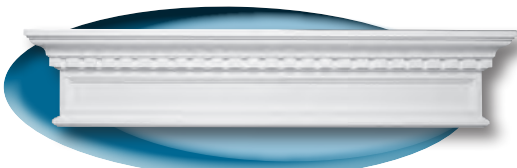

D120



D161



D140



D170



D150

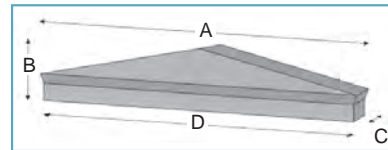

PART #	A	B	C	D
D120	48-5/8"	9-13/16"	3-3/8"	43-1/2"
D140	39-3/8"	12-3/8"	3/4"	-
D150	39-9/16"	6-1/8"	9-16"	-
D161	36-1/4"	8-7/16"	1-9/16"	-
D170	41-5/16"	9-7/8"	1-3/8"	-

Don't Forget...

Use ORAC FIX Extra and ORAC DecoFix Pro for perfect installation (see page 849).



? Did You Know...

Ask For our FREE Orac color catalog. Individual FREE Samples Available. **#A910**



Check measurements at job site before installing. We are not responsible for deviations of measurements in the catalog.

DOOR SURROUNDS

"Europe's #1 Choice for Interior Design"

MEASUREMENTS ARE APPROXIMATE



DUROPOLYMER®



D102, D62,
D1010, P9010, D300



SINGLE DOOR SURROUNDS

OPENING: Minimum 26³/₄" Wide
Maximum 41-5/16" Wide

PART #	W	H	D
D101	49-13/16"	7-11/16"	1-3/16"
P9010	3-3/4"	6'6"	1-3/16"
P9020	3-3/4"	6'6"	3/4"
D300	3-3/4"	10-1/4"	1-9/16"
D310	3-3/4"	9-13/16"	1-3/16"
D400	50-3/16"	5-11/16"	2-3/16"
D401	50-3/16"	5-11/16"	2-3/16"
D402	4-3/4"	5-3/4"	2-3/16"

DOUBLE DOOR SURROUNDS

OPENING: Minimum 53-1/8" Wide
Maximum 73-5/8" Wide

PART #	W	H	D
D102	82-1/2"	9-1/4"	1-3/16"
P9010	3-9/16"	6'6"	1-3/16"
P9020	3-3/4"	6'6"	3/4"
D300	3-3/4"	10-1/4"	1-9/16"
D310	3-3/4"	9-13/16"	1-3/16"

ACCESSORIES FOR SINGLE & DOUBLE DOOR SURROUNDS

PART #	W	H	D
D200	3-3/4"	3-3/4"	1-3/16"
D210	3-3/4"	3-3/4"	1-3/8"
D62	6-1/8"	4-9/16"	9/16"
D1010	12-3/16"	4-3/8"	1/4"
D1014	13"	5-5/16"	9/16"

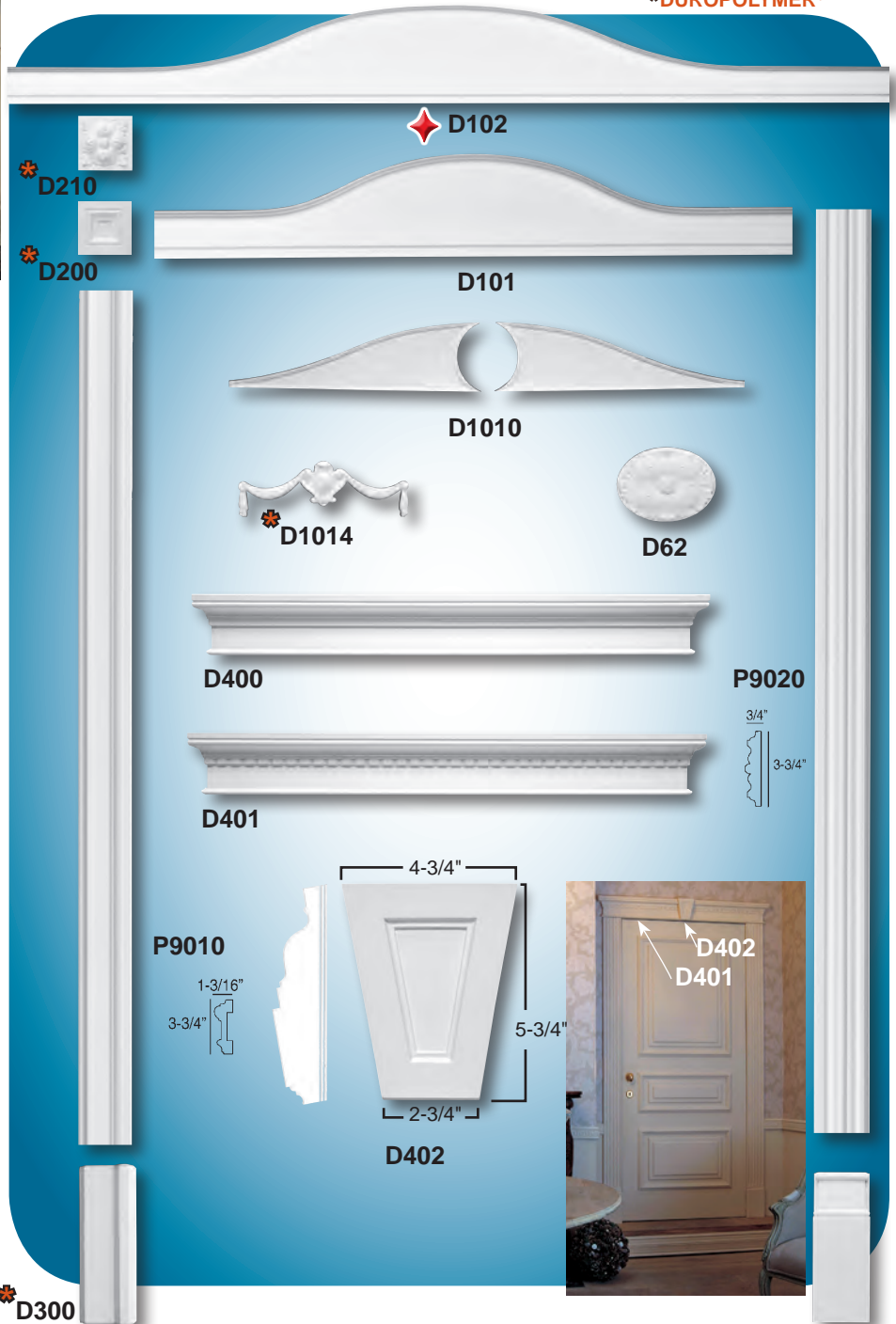

RAISED PANELS

"Europe's #1 Choice for Interior Design"



***DUROPOLYMER®**

MEASUREMENTS ARE APPROXIMATE



D503

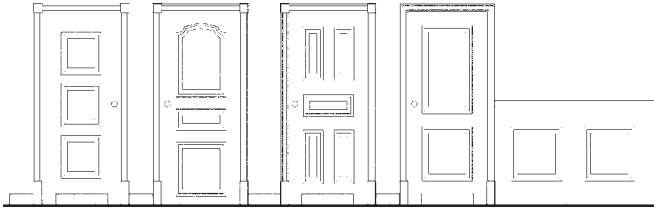

This range consists of different panels and a plinth that can be combined to give ordinary doors and walls that classical look of raised panels



D503 & D504



*D503



*D507

21-5/8" W x 35-5/8"H x 5/8" proj.



*D500

29-1/2"H x 21-5/8"W



*D506

16-15/16"x16-15/16"x5/8"



*D504

8-5/8"x21-5/8"

FIREPLACE SURROUNDS



H100

3 pc. set



NOT FOR USE WITH OPEN FLAME FIREPLACES!
(for functional fire surrounds, see pages 860-865)



MAXIMUM 2 KILOWATTS ON ELECTRIC FIREPLACES

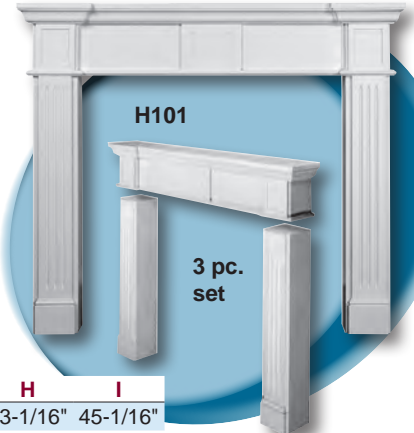
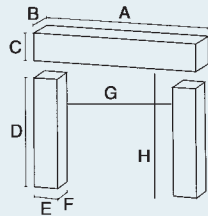

H101

3 pc. set

PART #	A	B	C	D	E	F	G	H	I
H100	51"	8-1/16"	12-3/16"	34-7/16"	7-7/8"	6-7/8"	34-5/8"	33-1/16"	45-1/16"
H101	50-3/4"	7-7/8"	9-7/16"	33-7/8"	5-7/8"	6-11/16"	35-1/4"	33-7/8"	43-5/16"

Don't Forget!
Use ORAC FIX Extra and ORAC DecoFix Pro for perfect installation (see page 849).



? Did You Know...

Ask For our FREE Orac color catalog. **#A910**
Individual FREE Samples Available.



CORBELS

"Europe's #1 Choice for Interior Design"



***DUROPOLYMER®**

MEASUREMENTS ARE APPROXIMATE

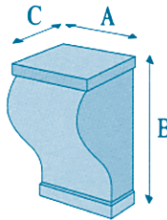
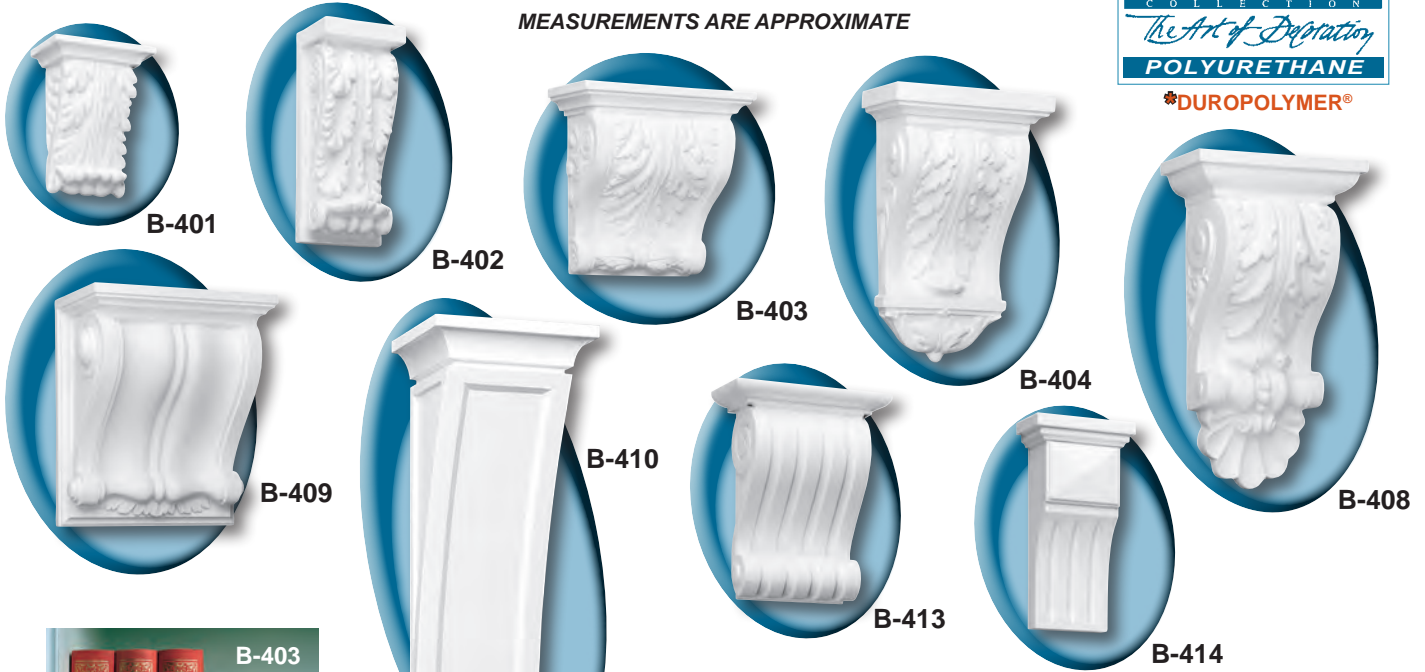

PART #	A	B	C
B-401	4-9/16"	6-5/16"	2-3/4"
B-402	3-9/16"	8-11/16"	2-3/4"
B-403	7-1/2"	7-1/2"	3-15/16"
B-404	7-11/16"	12-3/8"	4-9/16"
B-408	8-7/8"	15-3/4"	5-1/8"
B-409	11-13/16"	13-3/4"	6-7/8"
B-410	7-11/16"	19-11/16"	6-5/16"
B-413	6-5/16"	8-7/8"	3-3/8"
B-414	3-15/16"	8-5/8"	2-3/4"

WALL LIGHT SCONCES

THESE FIXTURES ACCEPT A STANDARD BASE BULB UP TO 60 WATTS

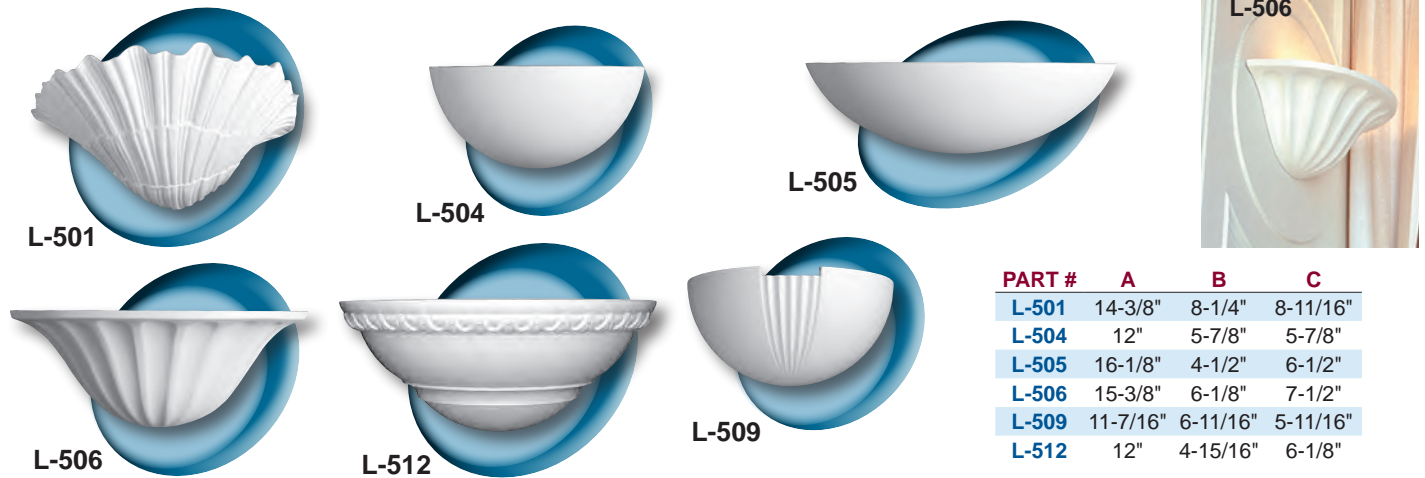

PART #	A	B	C
L-501	14-3/8"	8-1/4"	8-11/16"
L-504	12"	5-7/8"	5-7/8"
L-505	16-1/8"	4-1/2"	6-1/2"
L-506	15-3/8"	6-1/8"	7-1/2"
L-509	11-7/16"	6-11/16"	5-11/16"
L-512	12"	4-15/16"	6-1/8"

? Did You Know...

Ask For our FREE Orac color catalog. **#A910**
Individual FREE Samples Available.





MITER BOXES CAN BE USED FOR ORAC DECOR & SURROUNDS MOULDINGS

Decofix PRO

ADHESIVES

- For mounting elements within the Polyurethane & Duropolymer Collection.
- Basixx uses DecofixPro for Mounting & Joints



FDP-500

FDP-600



PART #	PCS. PER		DESCRIPTION
	CARTON		
FDP-500	12		Cartridge- 310 ml (10-1/2 oz.)
FDP-600	1		Tub- 8.8 lbs.

Decofix HYDRO For Exterior & Bathroom Applications

- For mounting elements within the Polyurethane Collection.
- For mounting and joining elements within Duropolymer collection.



FDP-700

PART #	PCS. PER		DESCRIPTION
	CARTON		
FDP-700	12		Cartridge-290 ml (9-3/4 oz.)

ORAC Fix Extra

- For joining elements within the Polyurethane & Duropolymer Collection in any application.

FX-200



PART #	PCS. PER		DESCRIPTION
	CARTON		
FX-200	12		Cartridge-310 ml (10-1/2 oz.)
FX-210	24		Tube-80 ml (2-3/4 oz.)

FX-210

ORAC FIX, ORAC DECOFIX PRO & ORAC DECOFIX HYDRO Technical Information

Keep ORAC Fix or ORACDecoFix Pro, cool (between +5°C/41°F and +30°C/86°F) and dry, can be stored for 12 months in original, unopened package

PRODUCT	REMOVABLE WITH	OPEN TIME	BASE	TEMP. PREP.
ORAC FIX EXTRA JOINT ADHESIVE	Acetone Before Hardening	Approx. 30 min.	Polyurethane (Diphenylmethane 4,4 - diisocyanate)	Between 5°C/41°F and 30°C/86°F
ORAC DECOFIX PRO	Water Before Hardening	Approx. 15 min.	Synthetic copolymer dispersion	Between 5°C/41°F and 30°C/86°F
ORAC DECOFIX HYDRO	Water and 1% Soap Before Hardening	Approx. 10 min.	One component Adh/Sealant Base On MS Polymer	Between 5°C/41°F and 30°C/86°F

We highly recommend testing your finish on a sample or scrap piece before installing.

MITER BOXES



FB-300 -Miter Box

ZX13 -Miter Box

ZX14 -Saw

PART #	PCS. PER CARTON	Max. Width & Height of Mldg.
FB-300	1	Width & Height 10.83"
ZX13	1	Width - 6.10" & Height - 4.92"
ZX14	1	----

ADJUSTABLE MITER BOX & SAW KIT



Cuts Any Degree

FB-10

Additional features for easy fixation and handling. 1 pc per carton
Moulding Max. Ht. 10.83" & Width 8.86" (for 45 degree)

ADHESIVE/FILLER YIELDS

MLDG. #	STANDARD PLUS CARTRIDGE FDP-500	STANDARD PLUS TUB FDP-600	EXTRA ADHESIVE CARTRIDGE FX-200	EXTRA ADHESIVE TUBE FX-210
P1020, P2020, P3020, P5021, P6020, P7050, P8020, P8030, P9040, P9050, C215, C230, C240, C250, C260, C322, C602	60 ft.	400 ft.	150 joints	35 joints
P4020, P5020, P5051, P7010, P7020, P7030, P7040, P7060, P7070, P8040, P8050, P8060, P9010, P9020, P9900, P9901, C200, C201, C212, C213, C214, C220, C302, C303, C304, C305, C308, C321, C400	45 ft.	300 ft.	100 joints	25 joints
P5050, P7080, C211, C216, C217, C218, C219, C300, C301, C307, C331, C332, C333, C334, C335, C336, C351, C353, C354, C355, C356, C357, C358, C360, C402, C422, C900, C901, C902, C990	30 ft.	200 ft.	80 joints	20 joints

Yields are approximate & based on average conditions & installation techniques.



LOW-DENSITY EXTRUDED POLYSTYRENE CROWN MOULDINGS

Our Affordable Low-density Extruded Polystyrene Crown Mouldings Offer Practical And Simple Installation.



- All mouldings available in 8' lengths
- No primer needed
- Ready for water/acrylic based paint
- Easy to install
- Water based adhesive only
- No nails or screws needed



EPS-4

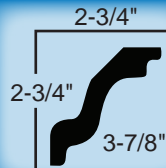

EPS-10

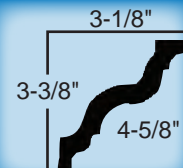

EPS-16

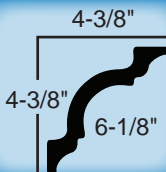

EPS-26

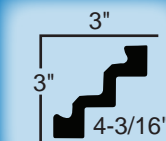
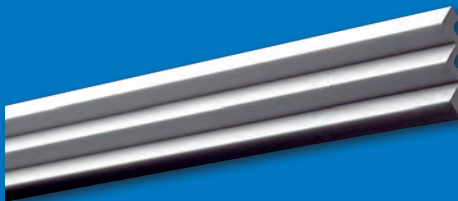

EPS-28

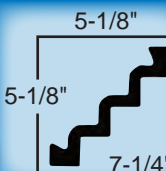

EPS-8

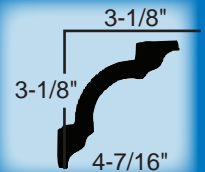

EPS-12

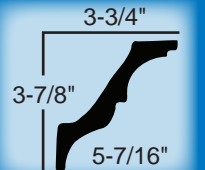

EPS-22

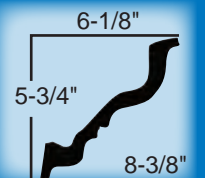

EPS-ADH



10.48 fl.oz.
each cartridge
covers
approximately
30' of moulding



Interior Millwork by Focal Point



HIGH DENSITY POLYURETHANE DISTINCTIVE CROWN MOULDINGS



Memorable Mouldings guide the eye and stir the spirit.
They can elevate a room from mundane to marvelous!



Athenian Leaves



23145

PART #	F	H	P	R	L
23145	4-1/8"	3-1/4"	2-9/16"	2-1/8"	8'



Classic Egg & Dart

23135

PART #	F	H	P	R	L
23135	4-1/8"	3-1/4"	2-1/2"	1-1/4"	8'

Zoller Cove

11280 11180 11290

PART #	F	H	P	R	L
11280	6"	4-1/4"	4-1/4"	-	12'
11180	8-7/8"	6-3/16"	6-3/16"	-	12'
11290	12-3/8"	8-3/4"	8-3/4"	-	12'

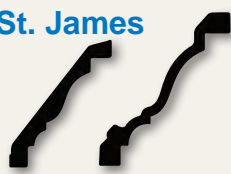

St. James

11170 11270

PART #	F	H	P	R	L
11170	6-1/4"	4-11/16"	4"	-	12'
11270	9"	7-7/16"	6-1/8"	-	12'



Georgian

11040 11320

PART #	F	H	P	R	L
11040	6"	4-3/8"	4-3/16"	3-7/16"	12'
11320	9-3/16"	6-7/8"	6"	5-1/4"	12'



Monte Carlo

10700-8

PART #	F	H	P	R	L
10700-8	6-9/16"	5"	4-5/16"	-	8'

Egg & Dart Crown

10530-8

PART #	F	H	P	R	L
10530-8	6-7/8"	5-1/16"	4-5/8"	1-3/4"	8'

Versailles Crown



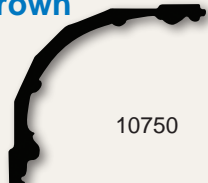

10750

PART #	F	H	P	R	L
10750-8	9-5/8"	6-7/8"	6-13/16"	-	8'

Note: We offer the complete line of **Focal Point** products.
If you do not see the **Focal Point** part you are looking for, Please inquire.

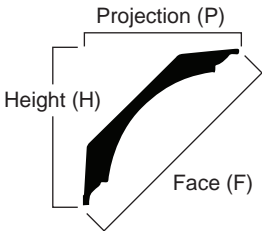
Profile Key



Length (L) of 1 piece of moulding.
Our moulding is typically made in 6'6", 8' or 12' lengths.
(Lengths may vary slightly due to pattern repeats.)





STAIR BRACKETS Stylish Stairways

Step up your style with our stair brackets. Reminiscent of the great mansions of Europe or the Antebellum South, our stair brackets are available in "right" or "left" configurations to match your staircase direction.

All brackets shown on this page are "right" brackets. Stair Brackets are sold in sets of two only.

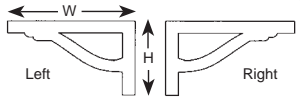

ROCOCO



99014 - Left
99024 - Right

W	H	P
11-7/8"	7-7/8"	3/4"

WOODLAWN-SMALL



99914 - Left
99924 - Right

W	H	P
8-1/4"	6-3/4"	15/16"

COLONIAL



99114 - Left
99124 - Right

W	H	P
12"	7-1/2"	1/2"

W = Width H = Height P = Projection R = Design Repeat L = Length in Feet



FRIEZES

GEORGIAN FRIEZE 15205



H	P	R	L
7-1/2"	1-3/4"	7-1/8"	92-1/4"

D'EVEREUX FRIEZE 13080



H	P	R	L
8-3/8"	1-1/8"	7-1/2"	12'

ADHESIVE



Focal Point Adhesive 3 is especially formulated to be used on polyurethane moulding joints and seams. It welds pieces together when properly used, virtually eliminating callbacks for joint separation. Use one tube of adhesive for every 60 linear feet of moulding. Immediately remove excess adhesive that bleeds on to the face of the moulding.

NOTE: PL Premium Polyurethane Construction Adhesive is the only recommended suitable alternative. Our warranty hinges on the use of Focal Point Adhesive 3 or PL Premium Polyurethane Construction Adhesive.

PART# 33333

PRIMED WHITE UNFINISHED MEDALLIONS



“Art for your ceiling”... medallions come in a wide array of styles, from classical to contemporary. “Enlighten” your light fixtures and your interior with medallions.

ACANTHUS



PART #	DIA. (D)	CANOPY (C)	PROJ.
81012	12"	5"	1/2"
81018	18"	5"	5/8"
81031	30-1/4"	5"	1-1/2"
81041	41"	5"	3/4"

RENAISSANCE



PART #	DIA. (D)	CANOPY (C)	PROJ.
81618	17-7/8"	4-3/8"	1-1/8"
81624	23-7/8"	5"	1-1/8"
81641	41"	6-1/2"	1-3/4"

ROTUNDA



PART #	DIA. (D)	CANOPY (C)	PROJ.
83012	12-3/8"	5"	1-3/16"
83018	18-1/2"	5"	1-1/8"
83024	24-5/16"	5-1/2"	1-3/8"
83031	31-3/8"	5-1/2"	1-1/2"
83034	34"	5-3/4"	2-3/4"
83041	40-7/8"	5-1/2"	2-1/8"

EGG & DART



PART #	DIA. (D)	CANOPY (C)	PROJ.
83324	24-7/16"	5-1/2"	1-1/2"
83331	31-7/16"	5-1/2"	1-1/2"



EMMA



PART #	DIA. (D)	CANOPY (C)	PROJ.
81024	23-11/16"	5"	2-3/4"

SHELL & BELLFLOWER



PART #	DIA. (D)	CANOPY (C)	PROJ.
83424	24-3/8"	5-1/2"	1-5/8"



C (Canopy)

A “canopy” is the decorative cover that is provided with the light fixture. This is installed against the medallion to cover and allow access to the electrical box opening. If you would like to use the canopy, Focal Point provides maximum “canopy size” information. Unless otherwise noted, the center holes of the medallions are approximately 4”

D (Diameter)

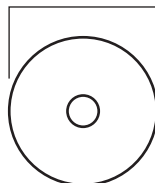

Note: We offer Focal Point’s full line of products. If you do not see the Focal Point part you are looking for, Please inquire.

VICTORIA



PART #	DIA. (D)	CANOPY (C)	PROJ.
87216	16"	4"	1"

Adding Character & Depth



Whether searching for a classic shell design, such as the Gainsborough or Regency, or a more contemporary feel, like the Sonoma or Monterey, niches provide an opportunity to ornament an area, highlight a special piece of artwork or create texture and depth on an otherwise flat space.



Gainsborough

91000

27-1/4"W x 56"H

91350

32-7/8"W x 58-1/2"H



Regency

91200

27-1/4"W x 56"H

91300

32-7/8"W x 58-1/2"H



Chatham

91240

29-3/4"W x 57-1/8"H



Bellemeade

91410

15-5/8"W x 29-7/8"H



Sonoma

91590

16-7/8"W x 36"H

91840

29-3/4"W x 56-3/4"H



Monterey

91520

16-7/8"W x 36"H



Waverly

91790

16-3/4"W x 36-1/2"H



Waverly II

91630

22-3/4"W x 43-3/8"H

91770

16-3/4"W x 36-1/2"H

Adding Character & Depth

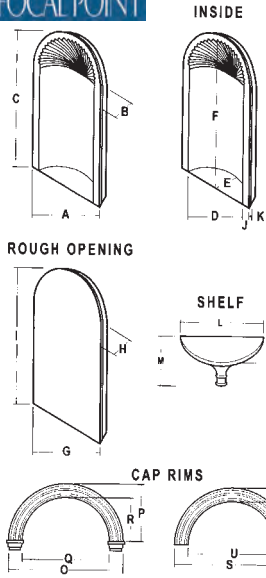

	Gainsborough		Regency		Chatham	Waverly II		Waverly	Bellemeade	Sonoma		Monterey
PART #	91000	91350	91200	91300	91240	91630	91770 [^]	91790 [^]	91410	91590 [^]	91840	91520 [^]
A	27-1/4"	32-7/8"	27-1/4"	32-7/8"	29-3/4"	22-3/4"	16-3/4"	16-3/4"	15-5/8"	16-7/8"	29-3/4"	16-7/8"
B	9"	9-7/8"	9"	9-7/8"	10"	7-5/8"	4"	4"	6-3/4"	5"	8-1/4"	5"
C	56"	58-1/2"	56"	58-1/2"	57-1/8"	43-3/8"	36-1/2"	36-1/2"	29-5/8"	36"	56-3/4"	36"
D	25-1/2"	31"	25-1/2"	31"	24"	17-3/4"	12-3/4"	12-3/4"	10-1/2"	13"	25-1/4"	13"
E	7-3/4"	9"	7-3/4"	9"	7-3/4"	6-5/16"	3-1/2"	3-1/2"	5"	3-1/2"	7-5/8"	3-1/2"
F	53-5/8"	56-1/2"	53-5/8"	56-1/2"	53-5/8"	39-13/16"	34-1/2"	34-1/4"	25-13/16"	33-5/16"	53-3/4"	33-5/16"
G	28"	33-1/2"	28"	33-1/2"	28"	21-3/8"	14-1/2"	14-1/2"	12-1/2"	14-1/2"	28"	14-1/2"
H	9-1/4"	10-1/2"	9-1/4"	10-1/2"	9-1/4"	7-1/4"	4"	4"	6"	4"	9-1/4"	4"
I	56-1/2"	59-1/2"	56-1/2"	59-1/2"	56"	42-1/2"	35-1/2"	35-1/2"	28-1/4"	35"	56"	35"
J	5-7/8"	5-7/8"	5-7/8"	5-7/8"	2"	2-3/8"	1-7/8"	1-7/8"	2-5/16"	1-3/4"	2"	1-3/4"
K	1-3/4"	1-3/4"	1-3/4"	1-3/4"	7/8"	9/16"	5/8"	5/8"	13/16"	1"	1-1/4"	1"
L	34-3/4"	41"	34-3/4"	41"	31-5/16"	25-9/16"	18-1/4"	17-1/4"	16-5/8"	17-1/4"	31-5/16"	17-3/4"
M	3-1/8"	3-1/4"	3-1/8"	3-1/4"	3-1/8"	8-7/8"	6-1/4"	3-1/8"	6"	3-1/8"	3-1/8"	3-1/8"
N	3-1/8"	3-1/8"	3-1/8"	3-1/8"	3-1/8"	7-1/2"	5-1/4"	3-1/8"	6-1/8"	3-1/8"	3-1/8"	3-1/8"
O	-	-	33-1/2"	39"	-	-	-	-	-	-	-	-
P	-	-	16-7/8"	21"	-	-	-	-	-	-	-	-
Q	-	-	24-1/8"	29-3/4"	-	-	-	-	-	-	-	-
R	-	-	13-3/8"	17-1/2"	-	-	-	-	-	-	-	-
S	32-1/4"	39-1/4"	-	-	-	-	-	-	-	-	-	-
T	8-1/8"	12-5/16"	-	-	-	-	-	-	-	-	-	-
U	25-1/4"	31"	-	-	-	-	-	-	-	-	-	-
V	11-5/8"	15-7/8"	-	-	-	-	-	-	-	-	-	-

[^]Fits standard 2 x 4 construction

NICHE SHELL CAPS



Create A Point Of Focus

Shell niche caps are used for two reasons - when a standard niche is not wide, tall or deep enough, or the project calls for shelves within the niche. The shell niche cap has a groove molded into the underside, into which bending plywood can be inserted and attached to the framing.

Geneva Shell Niche with Plinths, available in 3 sizes. The cap is separated from the casing by plinths, and curved-plywood used for the backing. Installed with Wood Casings 91110 or 91220 (sold separately), the overall niche can be any height, and made to fit your application.

Osborne Shell Niche Cap Kit, available in 3 sizes. Each kit contains a niche cap, rim, two pilasters. Installed with Fluted Pilasters 92260 (sold with kit). The backing is created using curved plywood or tempered hardboard cut to the desired size.

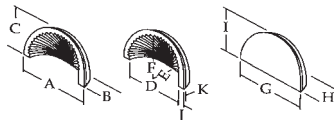

	PART #	Osborne			Geneva		
		91004	91005	91006	91001	91002	91003
Overall	WIDTH A	42-1/2"	29-3/4"	37-3/16"	42-1/2"	29-3/4"	37-3/16"
	DEPTH B	17"	10"	12"	17"	10"	12"
	HEIGHT C	23-1/2"	16-1/8"	18-1/4"	23-1/2"	16-1/8"	18-1/4"
Inside	WIDTH D	36"	24"	28-3/4"	36"	24"	28-3/4"
	DEPTH E	14-3/4"	8-1/2"	10"	14-3/4"	8-1/2"	10"
	HEIGHT F	20-1/4"	13"	14-3/8"	20-1/4"	13"	14-3/8"
Rough Opening	WIDTH G	40"	28"	34"	40"	28"	34"
	DEPTH H	16-1/2"	9-1/4"	11"	16-1/2"	9-1/4"	11"
	HEIGHT I	22-1/4"	15-1/2"	17-1/2"	22-1/4"	15-1/2"	17-1/2"
CASING		N/A	N/A	N/A	91110	91220	91110
PILASTER		60" - included in kit			N/A	N/A	N/A

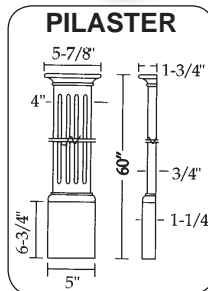

CASINGS - 8 Ft. Lengths

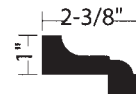

No. 91110
(use with 91001,
91003, niche cap)

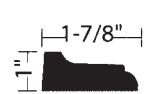

No. 91220
(use with 91002
niche cap)

FLEXIBLE "MADE TO FIT" MOULDINGS

Achieve Radii Never Before Possible- Available In 6 Ft. to 12 Ft. Lengths in even 1 Ft. Increments

IMPORTANT NOTES:

1. Material should be removed from box and stored flat when received. Allow it to come to room temperature 24 hours prior to installation.
2. For best results, the use of construction type adhesive in addition to pneumatic pin nailing is recommended. Use of tape or clamps may be helpful in securing the material in position while adhesives bond.
3. "Made-To-Fit" mouldings can be cut, shaped or sanded using normal woodworking equipment.
4. The use of water based stain such as Miniwax works well. Apply with brush or rag and wipe off. Additional coats may be applied if necessary to match wood. Be sure to allow first coat to dry completely before applying more stain. Finish with clear coat after staining.
5. All paints work well. Best results are seen when a primer coat is applied. When using Alkyd Enamels or Oil based Enamels a water base or Latex undercoat is required. Never paint before installation. The material is flexible and the paint may crack during installation.

***PLEASE NOTE: Flexible Mouldings May Shrink Up To 2% During Manufacturing (slightly more on larger profiles) in Size Compared To Rigid Mouldings.**

FLEXIBLE MOULDINGS ARE A NON-STOCK ITEM & HAVE A 3 WEEK LEAD TIME. EACH PIECE IS CUSTOM MADE, AND DEPENDING ON APPLICATION, RADIUS INFORMATION AND OR TEMPLATES MAY BE REQUIRED.

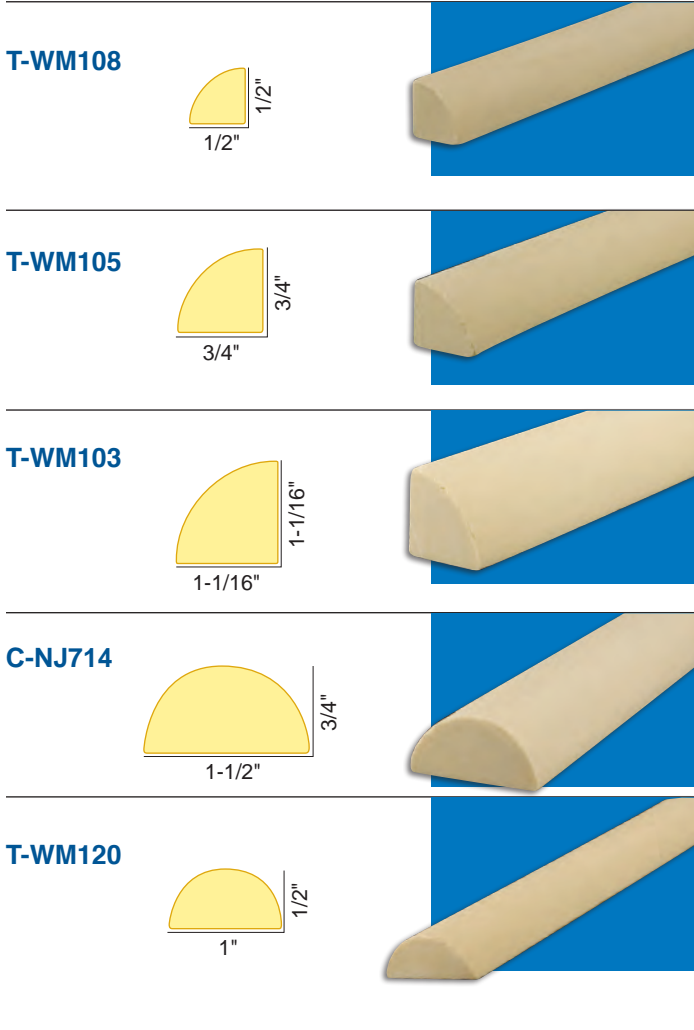

C-BB6

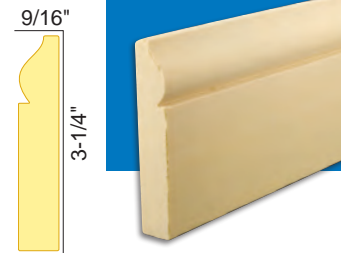

C-SM425

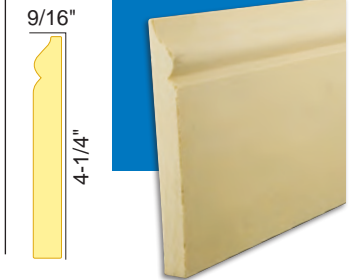

T-WM108



T-WM105

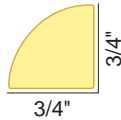

T-WM103

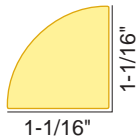

C-NJ714

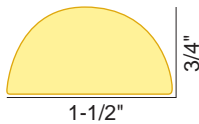

T-WM120

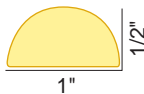

Max Radius 8"
Design Repeat: 7/8"

DE-903 (1"W x 3/8" Thick)

DE-904 (3/4"W x 1/4" Thick)

DE-905 (1/2"W x 1/4" Thick)

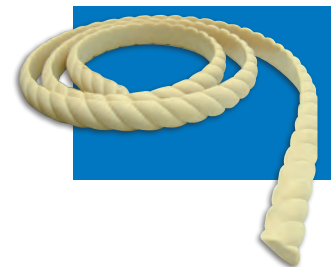
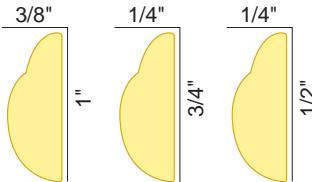

PART #	DESCRIPTION
A-2	2 oz. Adhesive (Approx 50' med bead)
AA-2	2 oz. Adhesive Accelerator (Approx 150' Coverage)

See pages 911-913, 920-926 for our Powder Coated Balusters

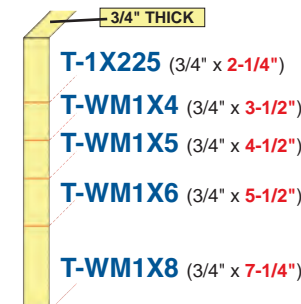

*** BECAUSE EACH PIECE IS MADE TO ORDER, THESE MOULDINGS ARE NON-RETURNABLE.**

FLEXIBLE "MADE TO FIT" MOULDINGS

Concave (inside) / Convex (Outside) Radius Applications:

Although radius information may not be required for this application, Profiles can not achieve a tighter radius than 3 times the width of the moulding. Example: A 3" wide moulding can achieve a radius of no tighter than 9". Attempting to do so may result in cracking.

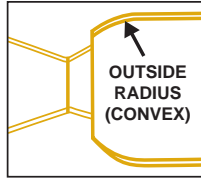
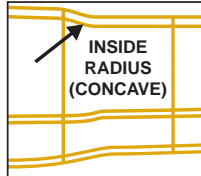

Casing Applications:

Half Round:

When ordering half circle radius casing, measure the distance across the opening at the widest point. This is the diameter of the circle (see diagram). The radius (height) dimension should be one half the length of the diameter. Specify the radius on your order.

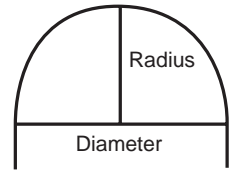

Eyebrow:

When ordering arches or arcs (also called eyebrows or sectionals), measure the height and width of the arch (see diagram). Specify these dimensions when ordering. Templates must be furnished when ordering elliptical and oval casings.

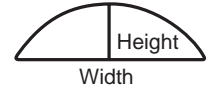

Elliptical:

Template required.



T-WM327

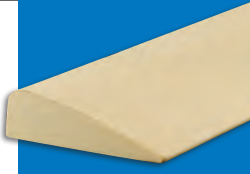
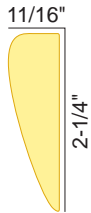

T-WM376



T-SL311

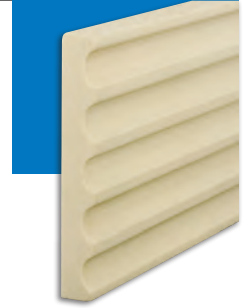

T-WM180.

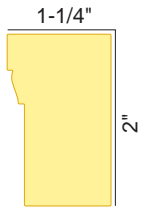

T-WM493.

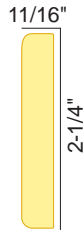

T-WM356

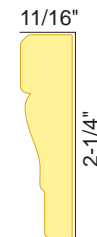

T-WM445

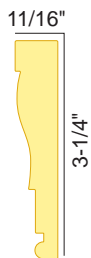

T-RB300

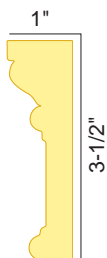

See pages 911-913, 920-926 for our Powder Coated Balusters

* BECAUSE EACH PIECE IS MADE TO ORDER, THESE MOULDINGS ARE NON-RETURNABLE.

MANTEL COLUMNS

TRADITIONAL STAIN GRADE HARDWOOD MANTEL COLUMNS

- 52" Columns w/Cap & Base.
- 3-1/2 or 5" dia. columns.

A quality stain grade column used in mantel applications, divider walls, and built in bookcases and entertainment centers. Manufactured from select hardwoods such as **Red Oak, Cherry, and Maple**. This column incorporates either a tapered shaft with true architectural entasis or a non-tapered shaft for a contemporary appearance. The classic hardwood column is available in both a plain or fluted shaft.

- A - 5" Dia. x 52" H, Fluted, Non-Tapered Column
 B - 3" Dia. x 52" H, Fluted, Non-Tapered Column
 C - 3" Dia. x 52" H, Plain, Non-Tapered Column
 D - 3" Dia. x 52" H, Plain, Tapered Column

THESE COLUMNS HAVE BEEN STAINED OR PAINTED FOR PHOTOGRAPHIC PURPOSES.

A Overall length include Tuscan Cap and Base.

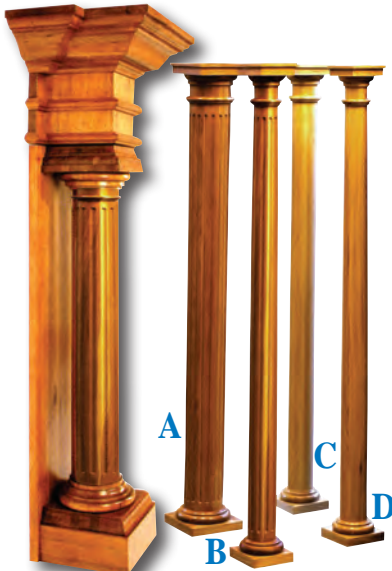

Available Tapered or NON-TAPERED PLAIN or FLUTED

RED OAK

PART

TAPERED	DR3X52P-RO
	DR3X52F-RO
	DR5X52P-RO
	DR5X52F-RO
NON-TAPERED	DR3X52NTP-RO
	DR3X52NTF-RO
	DR5X52NTP-RO
	DR5X52NTF-RO

CHERRY

PART

TAPERED	DR3X52P-CH
	DR3X52F-CH
	DR5X52P-CH
	DR5X52F-CH
NON-TAPERED	DR3X52NTP-CH
	DR3X52NTF-CH
	DR5X52NTP-CH
	DR5X52NTF-CH

MAPLE

PART

TAPERED	DR3X52P-MP
	DR3X52F-MP
	DR5X52P-MP
	DR5X52F-MP
NON-TAPERED	DR3X52NTP-MP
	DR3X52NTF-MP
	DR5X52NTP-MP
	DR5X52NTF-MP

MANTEL COLUMN DIMENSIONS

NAME	SIZE	BOTTOM DIA. A	NECK DIA. B	ABOVE BEAD M	BEAD I	FLUTE WIDTH L	TOP FLUTE K	BOTTOM FLUTE J	NO. FLUTE	LENGTH
TAPERED	3-1/2"	3"	2-13/16"	1-1/4"	5/16"	7/16"	5/16"	1/2"	12	52"
	5"	4-1/2"	3-7/8"	1-1/4"	5/16"	7/16"	5/16"	1/2"	20	52"
NON-TAPERED	3-1/2"	3"	3-3/8"	1-1/4"	5/16"	7/16"	5/16"	1/2"	12	52"
	5"	4-1/2"	4-7/8"	1-1/4"	5/16"	7/16"	5/16"	1/2"	12	52"

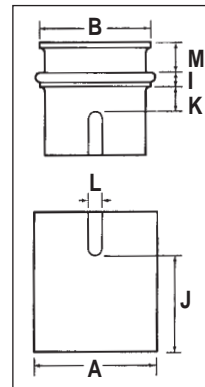

SPECIFICATIONS FOR TUSCAN CAPITAL AND BASE

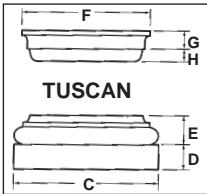

NAME	SIZE	BASE		CAPITAL			
		PLINTH C	MOLDING D	SQUARE		ROUND	
				E	F	G	H
TAPERED	3-1/2"	5"	1"	1-1/4"	4-1/2"	1-1/8"	5/8"
	5"	6-1/2"	1"	1-1/4"	4-1/2"	1-1/8"	5/8"
NON-TAPERED	3-1/2"	5"	1"	1-1/4"	5"	1-1/8"	5/8"
	5"	6-1/2"	1"	1-1/4"	6-1/2"	1-1/8"	5/8"

HALF ROUND & FULL ROUND COLUMNS

Available in Maple, White Oak and Cherry.

CAPS NOT AVAILABLE



HALF ROUND

BASE: W 6-1/4"

H: 9"

D: 2-3/4"

HWC2-MP (MAPLE)

HWC2-WHO (WHITE OAK)

HWC2-CH (CHERRY)

FULL ROUND

BASE: W: 6-1/4"

H: 9"

D: 5-1/2"

HWC2F-MP (MAPLE)

HWC2F-WHO (WHITE OAK)

HWC2F-CH (CHERRY)

OVERALL HT: 42-7/8"

CAPS NOT AVAILABLE



HALF ROUND

BASE: W: 6-3/8"

H: 7-7/8"

D: 2-3/4"

HWC8-MP (MAPLE)

HWC8-WHO (WHITE OAK)

HWC8-CH (CHERRY)

FULL ROUND

BASE: W: 6-3/8"

H: 8"

D: 5-3/4"

HWC8F-MP (MAPLE)

HWC8F-WHO (WHITE OAK)

HWC8F-CH (CHERRY)

OVERALL HT: 43"

AVAILABLE IN FULL ROUND ONLY!

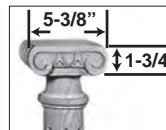

FULL ROUND with CAP

BASE: W: 6-1/2"

H: 6"

D: 6"

HWC7F-MP (MAPLE)

HWC7F-WHO (WHITE OAK)

HWC7F-CH (CHERRY)

OVERALL HT: 44-1/8"

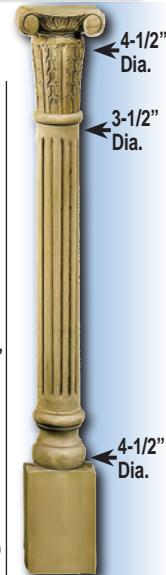

FULL ROUND with CAP

BASE: W: 5-3/4"

H: 9-5/8"

D: 2-1/2"

HWC10-MP (MAPLE)

HWC10-WHO (WHITE OAK)

HWC10-CH (CHERRY)

FULL ROUND

BASE: W: 5-3/4"

H: 9-5/8"

D: 5"

HWC10F-MP (MAPLE)

HWC10F-WHO (WHITE OAK)

HWC10F-CH (CHERRY)

OVERALL HT: 45"



HAND CARVED SOLID MAPLE FIRE SURROUNDS

Our solid wood maple surrounds are hand carved from one piece of wood by master European craftsmen who have passed their art down from generation to generation. Meticulously detailed in design, these surrounds create a dramatic look worthy of the finest hearths and fireplaces. Surrounds come unfinished, ready for stain to match your surrounding woodwork. Some filling, sanding and assembly may be required.



< **ML-2**

Inside Width: 58"
Inside Height: 42"
Body Width: 76-1/2"
Overall Height: 58-1/2"
Shelf Width: 83-1/8"
Shelf Depth: 10-1/2"

ML-2S

Inside Width: 50"
Inside Height: 40"
Body Width: 68-1/2"
Overall Height: 56-1/2"
Shelf Width: 75-1/8"
Shelf Depth: 10-1/2"



ML-7 >

Inside Width: 58"
Inside Height: 42"
Body Width: 76-1/2"
Overall Height: 54-3/4"
Shelf Width: 82"
Shelf Depth: 10-5/8"

ML-7S

Inside Width: 50"
Inside Height: 40"
Body Width: 68-1/2"
Overall Height: 52-3/4"
Shelf Width: 74"
Shelf Depth: 10-5/8"

Notes:

- All dimensions are approximate.
- Some assembly is required.
- All fire surrounds must ship freight.

HAND CARVED SOLID MAPLE FIRE SURROUNDS



< EP-14

Inside Width: 58"
Inside Height: 42"
Body Width: 72-1/4"
Overall Height: 55-3/8"
Shelf Width: 78-1/2"
Shelf Depth: 7-1/2"

EP-14S

Inside Width: 50"
Inside Height: 40"
Body Width: 64-14"
Overall Height: 53-3/8"
Shelf Width: 70-1/2"
Shelf Depth: 7-1/2"

Notes:

- All dimensions are approximate.
- Some assembly is required.
- All fire surrounds must ship freight.



FS-007 >

Inside Width: 58"
Inside Height: 42"
Body Width: 82-1/4"
Overall Height: 60"
Shelf Width: 89-1/2"
Shelf Depth: 10"

FS-007S

Inside Width: 50"
Inside Height: 40"
Body Width: 74-1/4"
Overall Height: 58"
Shelf Width: 81-1/2"
Shelf Depth: 10"

HAND CARVED SOLID MAPLE FIRE SURROUNDS



^ **ML-8**

Inside Width: 58"
Inside Height: 42"
Body Width: 72-1/2"
Overall Height: 53-1/8"
Shelf Width: 77-5/8"
Shelf Depth: 8"

ML-8S

Inside Width: 50"
Inside Height: 40"
Body Width: 64-1/2"
Overall Height: 51-1/8"
Shelf Width: 69-5/8"
Shelf Depth: 8"

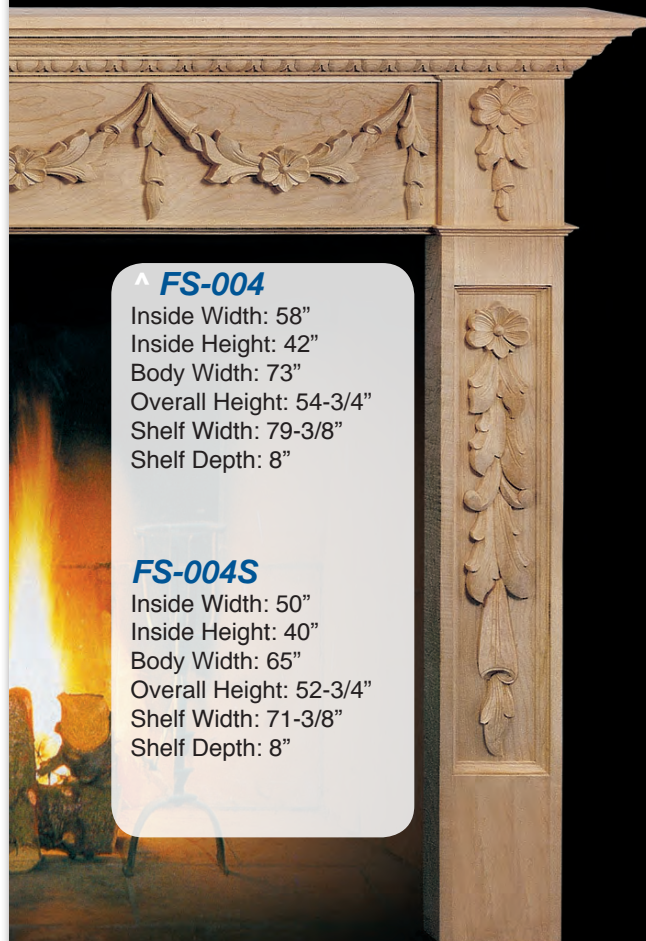

^ **FS-004**

Inside Width: 58"
Inside Height: 42"
Body Width: 73"
Overall Height: 54-3/4"
Shelf Width: 79-3/8"
Shelf Depth: 8"

FS-004S

Inside Width: 50"
Inside Height: 40"
Body Width: 65"
Overall Height: 52-3/4"
Shelf Width: 71-3/8"
Shelf Depth: 8"

Notes:

- All dimensions are approximate.
- Some assembly is required.
- All fire surrounds must ship freight.

CLASSIC WOOD FIRE SURROUNDS

ALL STYLES ARE AVAILABLE IN PAINT GRADE • OAK • CHERRY

Classic Styling... Exquisite Craftsmanship...

Why pay a mill worker to create a mantel for your home when we can provide the same quality craftsmanship at a fraction of the cost?

Old World Craftsmanship... Affordable Elegance...

We offer the best of both worlds. Our products are carefully constructed to give your home the beautiful look you want. From classic to contemporary, in unfinished oak veneer or paint grade (unfinished poplar), you'll find the style to suit your lifestyle.



1. Mt. Vernon (shown in Oak)



2. Victorian (shown in Paint Grade)



3. Harrisburg (shown in Paint Grade)



4. Fredricksburg (shown in Paint Grade)

	PART #	SIZE	NAME	Inside	Inside	Return	Shelf	Shelf	Leg	Leg &	Body	Total	Breast
				Opening	Opening		Depth	Length		Depth		Shelf	
				A	B	C	D	E	F	G	H	I	J
1	WFS-MVS-*	Small	Mt. Vernon	48"	42"	1-1/2"	72"	9"	7-1/4"	12"	62-1/2"	55"	13"
	WFS-MVL-*	Large		54"	42"	1-1/2"	78"	9"	7-1/4"	12"	68-1/2"	55"	13"
2	WFS-VIS-*	Small	Victorian	48"	42"	1-1/2"	77-1/2"	10 1/4"	10 1/4"	14 3/4"	68"	58-1/2"	16-1/2"
	WFS-VIL-*	Large		54"	42"	1-1/2"	83 1/2"	10 1/4"	10 1/4"	14 3/4"	74"	58-1/2"	16-1/2"
3	WFS-HAS-*	Small	Harrisburg	48"	42"	1-1/2"	75 1/2"	9 1/2"	9"	13-3/4"	66"	55"	13"
	WFS-HAL-*	Large		54"	42"	1-1/2"	81 1/2"	9 1/2"	9"	13-3/4"	72"	55"	13"
4	WFS-FRS-*	Small	Fredricksburg	48"	42"	1-1/2"	68"	7 1/2"	6"	10"	60"	55"	13"
	WFS-FRL-*	Large		54"	42"	1-1/2"	74"	7 1/2"	6"	10"	66"	55"	13"

Add color code to end of each part number when ordering (ex. WFS-MVS-OAK) *PG = Paint Grade, *OAK = Oak, *CH = Cherry

NOTE: Surrounds are finished for photographic purposes, yours will arrive unfinished.

CLASSIC WOOD FIRE SURROUNDS

ALL STYLES ARE AVAILABLE IN PAINT GRADE • OAK • CHERRY



5. Hillsboro (shown in Oak)



6. Leesburg (shown in Paint Grade)



7. Concord (shown in Oak)



8. Hartford (shown in Oak)

	PART #	SIZE	NAME	Inside	Inside	Return	Shelf	Shelf	Leg	Leg &	Body	Total	Breast
				Opening	Opening					Depth			
				A	B	C	D	E	F	G	H	I	J
5	WFS-HIS-*	Small	Hillsboro	48"	42"	1-1/2"	69 1/2"	8 1/2"	6"	10 3/4"	59 1/2"	55"	13"
	WFS-HIL-*	Large		54"	42"	1-1/2"	75 1/2"	8 1/2"	6"	10 3/4"	65 1/2"	55"	13"
6	WFS-LES-*	Small	Leesburg	48"	42"	1-1/2"	74 1/2"	9"	9"	13 1/4"	66"	55"	13"
	WFS-LEL-*	Large		54"	42"	1-1/2"	80 1/2"	9"	9"	13 1/4"	72"	55"	13"
7	WFS-COS-*	Small	Concord	48"	42"	1-1/2"	72 1/2"	7"	8 1/4"	12 1/4"	64 1/2"	56"	14"
	WFS-COL-*	Large		54"	42"	1-1/2"	78 1/2"	7"	8 1/4"	12 1/4"	70 1/2"	56"	14"
8	WFS-HARTS-*	Small	Hartford	48"	42"	1-1/2"	75 1/2"	8 5/8"	9 3/4"	13 3/4"	67 1/2"	59"	17"
	WFS-HARTL-*	Large		54"	42"	1-1/2"	81 1/2"	8 5/8"	9 3/4"	13 3/4"	73 1/2"	59"	17"

Add color code to end of each part number when ordering (ex. WFS-MVS-OAK) *PG = Paint Grade, *OAK = Oak, *CH = Cherry

NOTE: Surrounds are finished for photographic purposes, yours will arrive unfinished.

CLASSIC WOOD FIRE SURROUNDS

ALL STYLES ARE AVAILABLE IN PAINT GRADE • OAK • CHERRY



9. Oxford (shown in Oak)



10. Highlander (shown in Cherry)

			Inside Opening Width	Inside Opening Height	Return Depth	Shelf Length	Shelf Depth	Leg Width	Leg & Shelf Width	Body Width	Total Mantel Height	Breast Height
	PART #	SIZE	A	B	C	D	E	F	G	H	I	J
9	WFS-OXS.*	Small	48"	42"	1-1/2"	78"	11"	11"	15"	70"	59"	17 5/8"
	WFS-OXL.*	Large	54"	42"	1-1/2"	84"	11"	11"	15"	80"	59"	17 5/8"
10	WFS-HIGHS.*	Small	48"	42"	1-1/2"	66"	6 3/4"	5-3/4"	9 3/4"	59 1/2"	54 3/4"	12 3/4"
	WFS-HIGHL.*	Large	54"	42"	1-1/2"	72"	6 3/4"	5-3/4"	9 3/4"	65 1/2"	54 3/4"	12 3/4"

Add color code to end of each part number when ordering (ex. WFS-MVS-OAK) *PG = Paint Grade, *OAK = Oak, *CH = Cherry

NOTE: Surrounds are finished for photographic purposes, yours will arrive unfinished.

General Information

- Made to fit standard 36" and 42" wide fireboxes
- Available in unpainted MDF & hardwoods (paint grade/unfinished poplar/cherry) or stain grade/unfinished oak veneer
- Constructed of veneered MDF & select hardwoods
- Designed to overlap the facing material surrounding the firebox (tile, marble, slate, etc.) This allows flexibility in sizing and facing materials (see "C" dimension)
- Installation instructions are included with every order
- Installation requires basic tools and materials including construction adhesive, nails/screws and 1" x 2" x 4' lumber strips (which can be purchased locally)
- After some filling and sanding, surrounds can be finished with most quality paints or stains

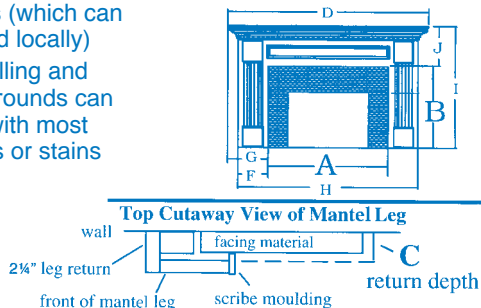

POLYURETHANE MANTEL HEADERS & LEGS



PART #	HEIGHT	WIDTH	PROJ.
DCOR-95-XL	41-1/2"	8-1/8"	7-1/4"

These decorative, high density ornaments are lightweight, primed and ready to paint.



PART #	HEIGHT	WIDTH	PROJ.
PFS-59	9"	59"	6-5/8"
<i>(3 Piece Set, 1 Header & 2 Legs)</i>			
Mantel Header			
HEIGHT	9"		
WIDTH	59"		
PROJ.	6-5/8"		
Mantel Leg			
HEIGHT	42-1/2"		
WIDTH	6-5/8"		
PROJ.	6-1/2"		

