

2014



HARDWARE COMPONENTS

HARDWARE COMPONENTS

Pgs. 263-342



Grommets



Tapes
(Double Coated
Adhesive)



Vents



Adjustable Cabinet Legs



Latches &
Catches



Computer Accessories



Wooden
Dowel
Pins



Binning
Strips



Drawer
Slides



Screws



Hinges
(Cabinet)

Power Center
Grommets



TV Lift
(Flat
Screen)



TV Wall
Mounts

Adjustment
Knobs



Beauty
Salon
Steel
Hardware



Sugatsune
Hardware
(Lid Stay)



Hinges (Piano-Continuous)

ADHESIVES & HOT MELT

BONDING SYSTEM.....	304-305
ADJUSTMENT KNOBS.....	279
ANCHORS (Toggle®).....	301
BEAUTY SALON STEEL HARDWARE	
Blow Dryer Holder Ring.....	267
Curling Iron Ring.....	267
Flat Iron Holder.....	267
BINNING STRIPS.....	307
BUMPON™ PROTECTIVE PRODUCTS (3M™).....	282-284
BUSHINGS (All-Fit Adjustable).....	270
CABINET COMPONENTS.....	286
CABINET LEGS	
A La Carte & Components.....	285
Adjustable Metal & ABS.....	285
CABLE CLAMPS (Wire Management).....	268
CABLE TIES (Nylon).....	268
COMPUTER ACCESSORIES.....	313
CORNER BRACES.....	286
CORNER PROTECTORS.....	286
COVER CAPS (Fast Cap Self Adhesive).....	290
DOWELS & DOWEL PINS	
Furniture.....	298
Wooden.....	297
DRAWER COMPONENTS.....	308-310, 312-313
DRAWER SLIDES.....	314-319
DRILL BIT SYSTEM (Flush Mount).....	290
DUST SEALS.....	287
FLOOR GLIDE & PROTECTOR.....	286
GLUE & STAPLE BLOCKS.....	286
GROMMET ACCESSORIES	
Hole Cutters.....	264
GROMMETS	
Dually (Fast Cap).....	266
Electrical Trim Ring (Fast Cap).....	266

GROMMETS

Executive Series (Metal & ABS).....	263
Outlet Accessory.....	266
Oval Wire Management.....	265
Power Center.....	274-275
Rectangular Wire Management.....	265
Round Wire Management.....	264
Trash Liners (Stainless Steel).....	267
Trash Receptacle (Plastic).....	267
HIDEACORD®.....	269
HINGES	
Cabinet.....	324-331, 342
Corner.....	329
Dampers.....	331
Euro.....	342
Flat (Plastic).....	333
Institutional.....	330
Lift-Up (Gas Spring).....	342
Non-Mortise Cylinder.....	331
Panel (Plastic).....	333
Piano (Continuous Steel).....	334
Plastic.....	332-333
Soft Stay Up.....	342
Specialty.....	329
Tee (Plastic).....	333
HOLE PLUGS (Nylon Locking).....	270
JOINERS & FASTENERS	
Arrow Clips.....	299
Canoe Clips.....	299
Furniture & Cabinet.....	295-296
Furniture Assembly.....	300
Ratchet Assembly Post & Screw.....	299
Row Boat Clips.....	299
Tree Clips.....	299
LATCHES & CATCHES.....	292-294

LOCKS.....	310-311
MIRROR CLIPS.....	289
NON-SKID PADS.....	284
PANTRY/CABINET PULL-OUT HARDWARE.....	322-323
POLYURETHANE ADHESIVE BUMPERS.....	284
POWER CENTER GROMMETS.....	274-275
POWER GROMMETS.....	272-278
QUICK TRAY ROLL OUT SYSTEM.....	320-321
RETAINER (Adjustable Panel/Glass).....	289
RETAINER (Panel).....	289
RETAINING BUTTONS (Glass/Panel).....	288
RETAINING CLIPS (No Route Glass/Panel).....	288
REVOLVING TURNTABLES (Lazy Susans).....	303
SCREW COVER CAPS.....	291
SCREWS (Flat & Pan Head Particle Board).....	300
SHelf RESTS (Plastic, Glass, Steel).....	280-281
STEM BUMPERS (Lexan & Butyrate).....	291
SUGATSUNE HARDWARE	
Lateral Opening Door Hinge.....	340
Lid Stay.....	337
Soft Close Dampening Hinge.....	335
Soft Closing Lid Stay.....	338-339
Soft Down Stays.....	336-337
Swing Lift Mechanism.....	341
SWIVELS.....	303
TABLE COMPONENTS.....	302
TAPES (Double Coated Adhesive).....	306
TV LIFTS (Flat Screen).....	276
TV WALL MOUNTS (Plasma/LCD).....	277
VENTS (Metal & Plastic).....	271
WASHERS (Finishing).....	300
WEDGES.....	286
WINDOW SHUTTER PINS.....	298
WIRE MANAGEMENT EXTRUSIONS.....	269

SEE PAGES 1007-1023 FOR A - Z INDEX

EXECUTIVE SERIES GROMMETS

1 The CEO

Material: Zinc Alloy

Cover has snap in mechanism with bristle hair cable management opening
2 sizes available

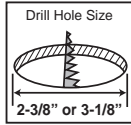

The CEO executive grommet



2

The Secretariat
Material: Zamak

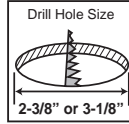

Cover has snap in mechanism with removable flexi-cap management opening
2 sizes available

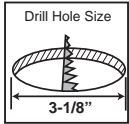

4 New
The Empire
Material: ABS

Two piece square cover with bristle hair cable management opening slot

3 The Capital **New**

Material: ABS

Two piece square cover with wire management slot gives a sleek modern look

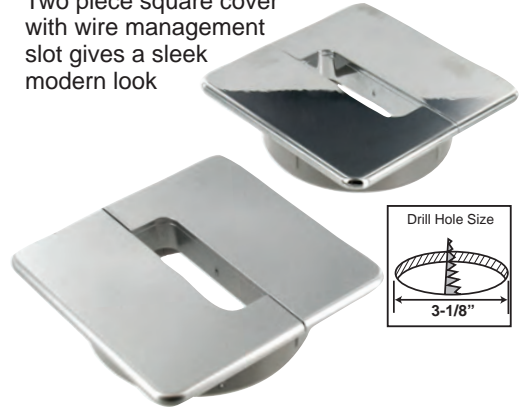

5 The Java **New**

Material: ABS

Two piece round cap has a 1-3/8 inch diameter opening when installed

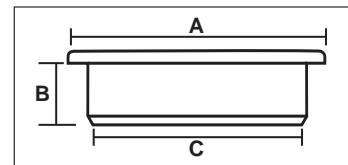
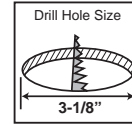

METAL

NUMBER	PART #	*FINISH	A (DIAMETER)	B (DEPTH)	C (DRILL HOLE SIZE)
1	M-60P*	Polished Chrome (PC)	2-5/8" (68mm)	55/64" (21.6mm)	2-3/8" (60mm)
	M-80P*	Satin Nickel (SN) Stainless Steel (SS)	3-15/32" (88mm)	55/64" (21.6mm)	3-1/8" (80mm)
2	M-60E*	Polished Chrome (PC)	2-5/8" (68mm)	13/16" (21mm)	2-3/8" (60mm)
	M-80E*	Brushed Nickel (B*)	3-1/2" (90mm)	13/16" (21mm)	3-1/8" (80mm)

ABS

Polished Chrome *(PC), Varnished Aluminum *(AL), Matte Black *(BK)

NUMBER	PART #	A (DIAMETER)	B (DEPTH)	C (DRILL HOLE SIZE)
3	P-C80*	3-45/64" (94mm)	55/64" (21.6mm)	3-1/8" (80mm)
4	P-M80*	3-43/64" (93mm)	55/64" (21.6mm)	3-1/8" (80mm)
5	P-J80*	3-3/4" (95mm)	55/64" (21.6mm)	3-1/8" (80mm)

ROUND WIRE MANAGEMENT GROMMETS

26 SERIES: TELEPHONE WIRE GROMMETS

PRODUCT FEATURES:

- Material: ABS
- 1-1/8" overall diameter
- Accepts cards up to 13/16" wide

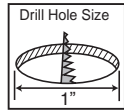

PART #	DRILL HOLE DIAMETER	COLOR
26BK	1"	Black
26WH	1"	White

FLEXI SERIES

PRODUCT FEATURES:

- Material: ABS
- *Color: Black (BK), Silver Gray (SG), White (WH), Brown (BR), Gray (GR), Almond (AL), and Beige (BE)
- Easy maneuvering of wires



PART #	SIZE
G31-*	60mm
G32-*	80mm

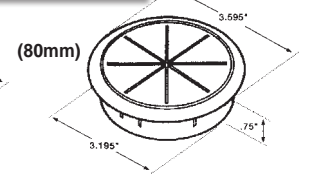
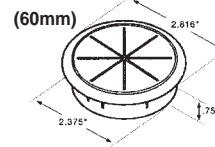

31 SERIES

PRODUCT FEATURES:

- Material: ABS
- Each set contains a grommet, grommet cap & a slot cover; slot cover stores under cap & out of sight when system is in use

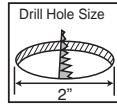

PART #	DRILL HOLE DIA.	COLOR
31DG	2"	Dove Gray
31BR	2"	Brown
31BK	2"	Black
31PT	2"	Putty
31WH	2"	White

35 SERIES

PRODUCT FEATURES:

- Material: ABS.
- Includes retractable/self-storing slot cover
- When closed, cover offers a flat profile with neat, uniform surface & shape; open position provides large enough opening with easy access for cover retrieval or removal of entire cap system from grommet

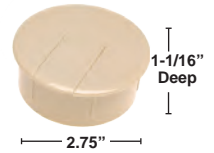

* Fits 2-3/4" hole; 3" is dia. dimension.



PART #	DRILL HOLE DIA.	COLOR
35DG	2-3/4"	Dove Gray
35BR	2-3/4"	Brown
35BK	2-3/4"	Black
35PT	2-3/4"	Putty
35WH	2-3/4"	White

ECONO SERIES

PRODUCT FEATURES:

- Material: ABS
- Color: Black
- Textured Cap
- 1" Depth

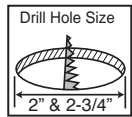

PART #	DRILL HOLE DIAMETER
T31-BK	2"
T35-BK	2-3/4"

SPRING LOADED GROMMET

PRODUCT FEATURES:

- Material: ABS
- Easy access to wires. Simply push down on door with finger and slide to the left or right.
- Black (BK) or Silver (SL) top
- One piece construction, no lost tabs or cap
- 7/16" Depth

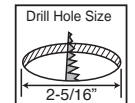

PART #	DRILL HOLE DIA.
SPG60-BK	2-5/16"
SPG60-SL	2-5/16"

GROMMET HOLE CUTTERS

SAFE - DURABLE - SHATTER RESISTANT

- Electronically fused steel to carbide tip makes a tough, strong tool you can be proud to own!

- Carbide tipped deep throat hole saws are designed to safely extend the usual range of your portable drill, drill press and lathe. For fast, easy production cutting of abrasive construction materials such as fiberglass, plywood, plasterboard, transite, flakeboard, fiberboard & wood. You can expect this saw to outlast 5 regular saws. Arbor uses a 1/4" pilot drill.



1-3/4" DEEP CUTTING

PART #	CUTS FOR:
FHC-2 (2")	#31-2" Round
FHC-275 (2-3/4")	#35-3" Round
FHC-4125 (4-1/8")	#37 Wine Ring
FHC-2125	2-1/8" Dia.
FHC-225 (57mm)	2-1/4" Dia.

ARBOR:



PART #
FHA-335

ROUND WIRE GRIPPING GROMMETS

PRODUCT FEATURES:

- Material: High Impact Styrene
- 1-1/4"
- Fits into 1-1/8" diameter hole

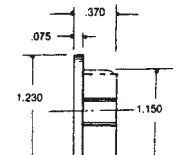
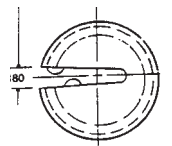

PART #	COLOR
27BR	Brown
27BK	Black
27WH	White

OVAL WIRE MANAGEMENT GROMMETS

39 SERIES

PRODUCT FEATURES:

- Material: Polystyrene
- 3-1/2" x 2" overall
- Can fit over sized cords
- Can handle multiple cords

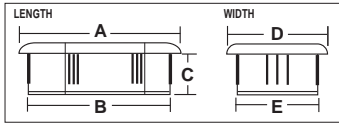

PART #	COLOR	A	B	C	D	E
39BK	Black					
39WH	White	3-1/2"	3-1/4"	9/16"	2"	1-3/4"
39GR	Gray					

OV32 SERIES



PRODUCT FEATURES:

- Material: ABS
- Color: Black
- Can close wire doors when not in use

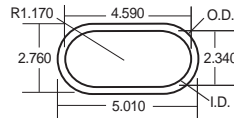
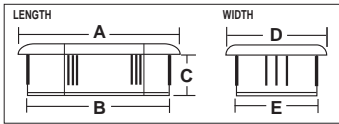
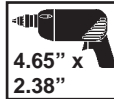

PART #	A	B	C	D	E
OV32-BK	5"	4.65"	.98"	2.77"	2.38"

SUPER SIZED GROMMET

PRODUCT FEATURES:

- Material: ABS
- Color: Black
- 2 parts with removable cap and elongated tab

Overall Dimensions: 75mm (3.00") x 166mm (6.64").

Depth: 17.5mm (.70").

Routing Dimensions: 65.5mm (2.62") x 156.5mm (6.26").



PART #
SSG4214-BK

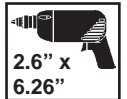

RECTANGULAR WIRE MANAGEMENT GROMMETS

32 SERIES



- Deep bushings designed for wood furniture with wider insert legs for desks or table tops 1-1/4" thick; shallow version for metal furniture applications includes a "variable gauge" bushing that snaps into the cutout and is secured by 4 pins
- Streamlined in appearance and accommodates a 1-7/8" x 3-1/4" cutout with 5/16" radius corners
- Perfect for most business machine leads, coaxial computer cables and telephone cords



CAP #4 (OVAL)

CAP #2 (CIRCULAR)

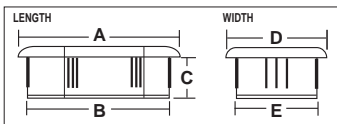

PART #	CAP STYLE	COLOR	A	B	C	D	E
32BK-4	Oval (-4)	Black	3-1/2"	3-1/4"	5/8"	2"	1-7/8"
32BKD-2	Oval (-4) Round (-2)	Black	3-1/2"	3-1/4"	1-7/16"	2"	1-7/8"

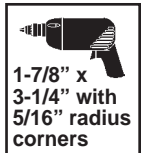

33 SERIES: PAPER SLOT GROMMET



PRODUCT FEATURES:

- Material: ABS
- 2 insert depths included (3/4" -1-13/16" & 1"-1/16")
- Color: Black
- Accommodates paper up to 17"

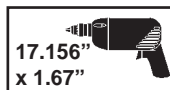
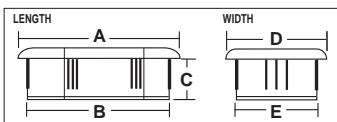
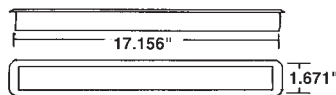

PART #	CAP STYLE	A	B	C	D	E
33BK	N/A	17-7/8"	17-5/32"	13/16"	2-3/8"	1.67"

MULTI-WIRE GROMMETS



PRODUCT FEATURES:

- Material: ABS
- **Black***
- 4 Removable tabs for a variety of wire management options

Overall Dimensions: 52mm (2.08") x 104mm (4.16").

Depth: 15.5mm (.62").

Routing Dimensions: 45mm (1.80") x 98mm (3.92").

*Other colors available. Please inquire. Minimums apply.

PART #
MWG5214-BK

FAST CAP ELECTRICAL TRIM RING

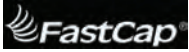

New

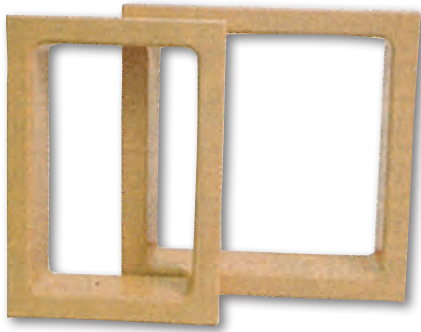

PRODUCT FEATURES:

- Material: ABS
- Clean up electrical cut outs
- Available for single or double gang boxes
- 1-1/4" depth with trim lines every 1/4"

Colors Available:



PART #	DESCRIPTION	*COLOR
ETR-S*	Single	White (WH), Black (BK), Almond (AL), & Hardrock Maple (HM)
ETR-D*	Double	White (WH), Black (BK), Almond (AL), & Hardrock Maple (HM)

DUALY GROMMET



New



PRODUCT FEATURES:

- Material: ABS
- Finishes both sides of the hole
- Fits material thickness 3/4" to 2-1/2"
- Trimmable - Markings every 1/4"
- 2-1/4" ID

Colors Available:

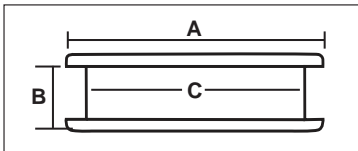

PART #	*COLOR	A	B	C
DG25*	White (WH), Black (BK), Almond (AL), & Hardrock Maple (HM)	3-11/32"	2-1/2"	2-1/2"

OUTLET ACCESSORY GROMMET

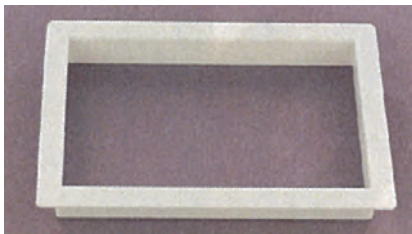

PRODUCT FEATURES:

- Material: Styrene
- 4-7/16" x 6-7/16" overall
- 11/16" Deep
- 3-13/16" x 5-13/16" hole size

PART #	COLOR
G1032-BK	Black
G1032-WH	White

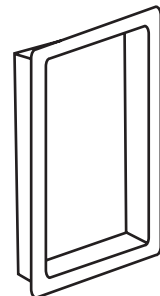

STAINLESS STEEL TRASH LINERS

New & Improved

Material- 304 Stainless Steel

PRODUCT FEATURES:

- Brushed finish
- Perfect for use in restaurants, doctor's offices, hospitals, boats, RV's and public restrooms.
- Overlapping trim edge gives professional finished look.

PART #	DIAMETER	HEIGHT
TL-061		1"
TL-062	6"	2"
TL-066		6"
TL-101	10"	1"
TL-102		2"
TL-121	12"	1"

Other Sizes Available - Please Inquire

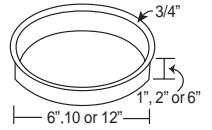

Material Thickness: .020"

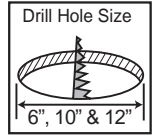

PLASTIC TRASH RECEPTACLE GROMMET

38 SERIES Material: Polystyrene

PART #	DIAMETER	COLOR
38BK	6"	Black
38WH	6"	White

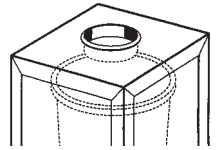
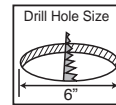

2 New Finishes FOR HAZMAT & RECYCLABLES WASTE

Red & Green

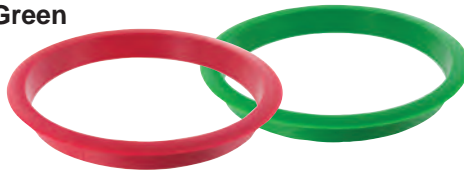

PART #	DIAMETER	COLOR
38GR	6"	Green
38RD	6"	Red

BEAUTY SALON STEEL HARDWARE



Material: 304 Stainless Steel

PRODUCT FEATURES:

- Polished Stainless
- Super strong
- Multiple styles available for maximum storage ability



BLOW DRYER HOLDER RING

- Holds nozzle up to 3" in diameter

PART #
BSH-BD3

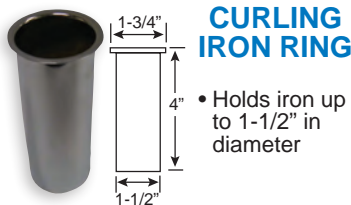
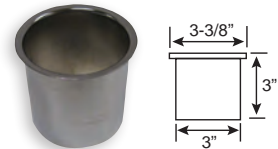

CURLING IRON RING

- Holds iron up to 1-1/2" in diameter

PART #
BSH-CU15

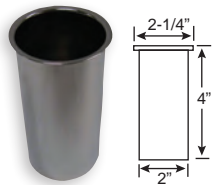

CURLING IRON RING

- Holds iron up to 2" in diameter

PART #
BSH-CU2



FLAT IRON HOLDER

- Holds standard size irons (2-1/4" to 2-1/2")

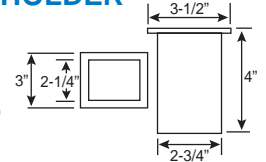

PART # **FINISH**
BSH-FL Brushed Stainless
BSH-FL-POL Polished Stainless

CABLE CLAMPS

REACH & ROHS COMPLIANT

NATURAL NYLON

These nylon cable clamps are perfect for applications in electronics, automotive, air craft, appliance and many other industries. The Standard Series has a 3/8" wide contact area and is designed for medium to lightweight applications.

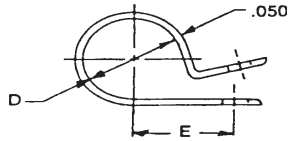
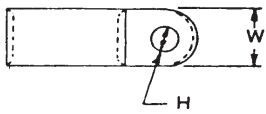

* USE #10 PANHEAD FOR ALL

STANDARD

PART #	D	W	H	E
CC-0187	3/16"	3/8"	.140 (#6)	.430
CC-0250	1/4"	3/8"	.167 (#8)	.410
CC-0312	5/16"	3/8"	.167 (#8)	.495
CC-0375	3/8"	3/8"	.167 (#8)	.595
CC-0500	1/2"	3/8"	.167 (#8)	.605

Larger Sizes Available up to 1-1/2"

HEAVY DUTY

PART #	D	W	H *	E
HDCC-018	3/16"	1/2"	.203	.425
HDCC-025	1/4"	1/2"	.203	.410
HDCC-031	5/16"	1/2"	.203	.500
HDCC-037	3/8"	1/2"	.203	.530
HDCC-050	1/2"	1/2"	.203	.595
HDCC-062	5/8"	1/2"	.203	.655
HDCC-075	3/4"	1/2"	.203	.780
HDCC-100	1"	1/2"	.203	.910

QUICK RELEASE CABLE CLAMPS

NATURAL NYLON WITH ADHESIVE

These adhesive backed nylon wire & cable clips are used to route wire & cables. The parts are backed with polyurethane foam tape & feature a releasable clip so wires can be removed after assembly if desired.

REACH & ROHS COMPLIANT

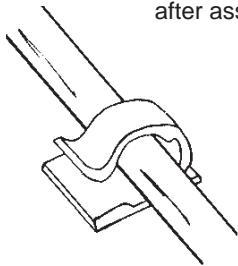

*Also available in Black.

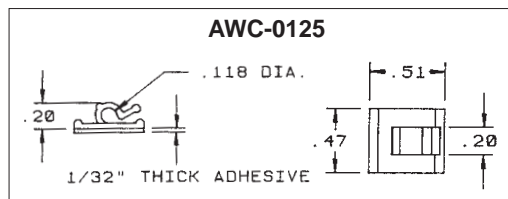

PART #	SIZE
AWC-0125	1/8"
*AWC-0375	3/8"

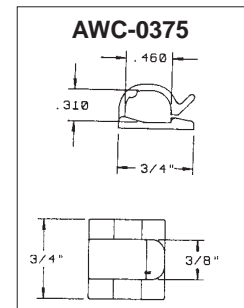

NYLON CABLE TIES

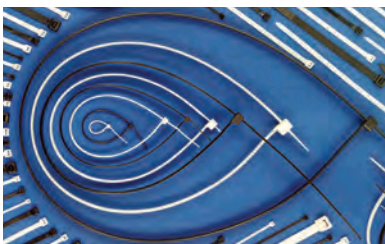

PART #	COLOR	LENGTH	BUNDLE DIA. MIN - MAX	TENSILE STRENGTH
NCT-400	Natural	4"	1/16" - 7/8"	18 lbs.
NCT-400BK	Black	4"	1/16" - 7/8"	18 lbs.
NCT-550	Natural	5-1/2"	1/16" - 1-1/4"	40 lbs.
NCT-550BK	Black	5-1/2"	1/16" - 1-1/4"	40 lbs.
NCT-800	Natural	8"	1/16" - 2-1/8"	40 lbs.
NCT-800BK	Black	8"	1/16" - 2-1/8"	40 lbs.
NCT-1500	Natural	15"	1/16" - 4"	50 lbs.
NCT-1500BK	Black	15"	1/16" - 4"	50 lbs.

WIRE MANAGEMENT EXTRUSIONS

8 FT. LENGTHS - Black PVC

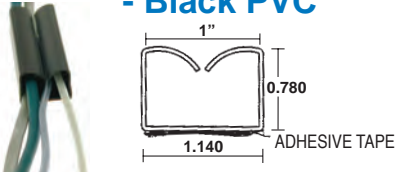

PART #
2243-BK

WIRE & CABLE ORGANIZATION CHANNEL - 8 FT. LENGTHS Black Virgin Vinyl

Channel's are supplied with self adhesive tape. This product is used to store and organize wire, computer cable, phone/fax lines, electrical cords and other wiring devices on such items as entertainment centers, computer work stations, desks & home theater systems

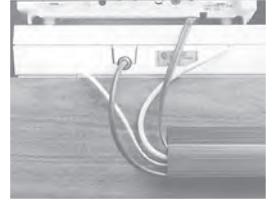

OPEN CHANNEL

PART #	A	B	C
CWM15-BK	2.340"	1.090"	.753"

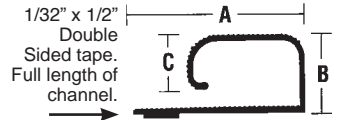

LOCK CLOSE CHANNEL

PART #	A	B	C	FULL BOX QTY
CWM30-BK	.770"	.410"	.143"	800'
CWM50-BK	1.010"	.550"	.194"	672'
CWM10-BK	1.510"	.770"	.242"	320'

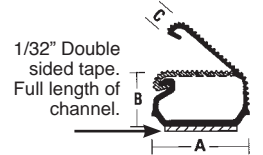

1" CLIPS

PART #	DESCRIPTION	A	B	C
CWM15-BK32	Black Open 1" Clip w/adhesive	2.34	1.09	0.753
CWM10-BK32	Black Lock Close 1" Clip w/adhesive	1.51	0.77	0.242

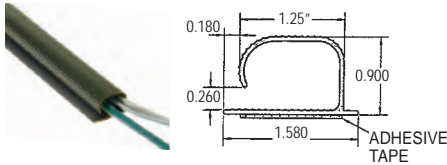

PART #
5200-BK

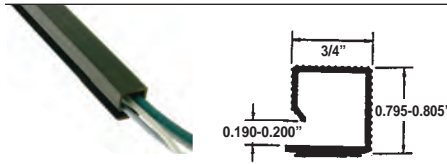

PART #
5230-BK

RACEWAY ON-A-ROLL

1/4" SIZE
INSIDE DIMENSIONS
.255" x .125"



3/8" SIZE
INSIDE DIMENSIONS
.375" x .375"

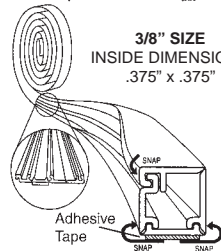

- Folds into a rigid PVC channel for wire or cable installations
- Easy for storage for up to 50 ft. and 100 ft. of raceway
- Low cost-High quality
- Perfect for around windows and doors
- Adhesive backing for fast-easy installation
- UL94VO Rated - flame retardant PVC

PART # DESCRIPTION

FWF-25511	1/4" White
FWF-25521	1/4" Beige
FWF-14511	3/8" White
FWF-14521	3/8" Beige
FWF-05511	1/2" White
FWF-05521	1/2" Beige
FWF-10511	1" White
FWF-10521	1" Beige

50 FT.
COIL

PART # DESCRIPTION

FWF-14111	3/8" White
FWF-14121	3/8" Beige
FWF-05111	1/2" White
FWF-05121	1/2" Beige

100 FT.
COIL

WIRE MANAGEMENT FOR 2-3/8" (60mm) ROUND TABLE LEGS

5 Ft. Lengths w/Adhesive
Black

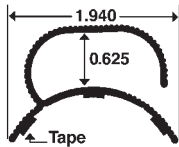

PART #
CWM-1575-BK



HIDEACORD®

SELF ADHESIVE ELECTRICAL WIRE COVER SYSTEM

1300-WH, 1300-BK
102cm WIRE COVER

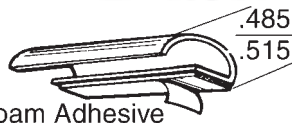

- 8 Ft. Lengths.
- Rigid ABS Plastic.
- Available In White & Black (Can Be Painted To Match Wall Colors).
- Installs In Minutes.
- Can Be Used On Walls, Baseboards, Ceilings, Etc.
- No Tools Required.
- Simple And Easy To Use.

PART#	DESCRIPTION
1300-WH	102cm Wire Cover-White w/Adhesive
1300-BK	102cm Wire Cover-Black w/Adhesive

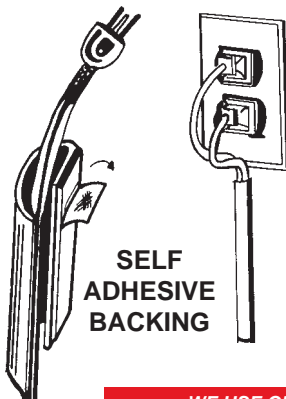

SELF
ADHESIVE
BACKING

Foam Adhesive

WE USE ONLY HIGH QUALITY, GENERAL USE ADHESIVE TAPES. EACH CUSTOMER ASSUMES RESPONSIBILITY OF TESTING THE PRODUCT FOR THEIR SPECIFIC APPLICATION. WE WILL SUPPLY SAMPLES FOR THIS PURPOSE. SPECIAL NEEDS CAN BE ACCOMMODATED ON A PER RUN BASIS.

NYLON LOCKING HOLE PLUGS



- DESIGNED WITH MULTIPLE LOCKS TO SNAP IN PANEL THICKNESSES FROM 1/64"-1/8".
- USED TO CLOSE EXCESS CHASSIS HOLES, WIRING OUTLETS & PRODUCTION ACCESS HOLES.
- SUITABLE FOR CRITICAL OR ELEVATED TEMPERATURE APPLICATION.
- CAN ALSO BE USED FOR WOOD PANEL.
- HEAT STABILIZED NYLON (UL94V2).
- ABS FLAMMABILITY RATING (94-HB).

REACH & ROHS COMPLIANT

CLEAR

PART #	CHASSIS DIMENSIONS		PART DIMENSIONS	
	HOLE DIA.	MAXIMUM THICKNESS	A HEAD DIA.	B THICKNESS
MP-1000CL	1"	1/8"	1.125	.453

BLACK OR WHITE All available in Black, or add a "W" for White.

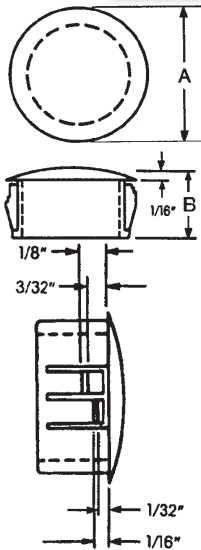

PART #	CHASSIS DIMENSIONS		PART DIMENSIONS	
	HOLE DIA.	MAXIMUM THICKNESS	A HEAD DIA.	B THICKNESS
MP-0187	3/16"	1/16"	.250	.234
MP-0250	1/4"	1/16"	.312	.312
MP-0312	5/16"	1/16"	.375	.312
MP-0375	3/8"	1/8"	.468	.406
MP-0437	7/16"	1/8"	.531	.406
MP-0500	1/2"	1/8"	.578	.406
MP-0562	9/16"	1/8"	.656	.406
MP-0625	5/8"	1/8"	.718	.406
MP-0750	3/4"	1/8"	.922	.406
MP-0875	7/8"	1/8"	1.016	.453
MP-1000	1"	1/8"	1.203	.453
MP-1093	1-3/32" - 1-7/32"	1/8"	1.218	.453
MP-1187	1-3/16"	1/8"	1.312	.453
MP-1250	1-1/4"	1/8"	1.375	.453
MP-1375	1-3/8"	1/8"	1.500	.453
MP-1500	1-1/2"	1/8"	1.672	.453
MP-1750	1-3/4"	1/8"	1.906	.453
MP-2000	2"	1/8"	2.140	.453

LOCKING VENTED HOLE PLUGS

All available in Black, or add a "W" for White.

REACH & ROHS COMPLIANT

PART #	HOLE DIA.	MAXIMUM THICKNESS	A HEAD DIA.	B THICKNESS
MP-0750V	0.750"	0.125"	0.906"	0.406"
MP-0875V	0.875"	0.125"	1.1016"	0.453"
MP-1000V	1.00"	0.125"	1.203"	0.453"

REMOVABLE VENTED NYLON PLUGS AVAILABLE, PLEASE INQUIRE!

ALL-FIT ADJUSTABLE BUSHING IN BLACK

NYLON

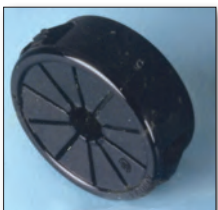

PART #	HOLE DIAMETER	B HEAD DIA.	C THICKNESS	MAX WIRE
AF-0625	5/8"	0.718"	0.406"	0.437"
AF-0750	3/4"	0.859"	0.390"	0.500"
AF-0812	13/16"	0.890"	0.390"	0.500"
AF-0875	7/8"	0.937"	0.453"	0.562"
AF-1000	1"	1.062	0.453"	0.750"
AF-1093	1-3/32"	1.156"	0.453"	0.812"
AF-1250	1-1/4"	1.360"	0.453"	0.875"

REACH & ROHS COMPLIANT

PLASTIC VENT GRILLES

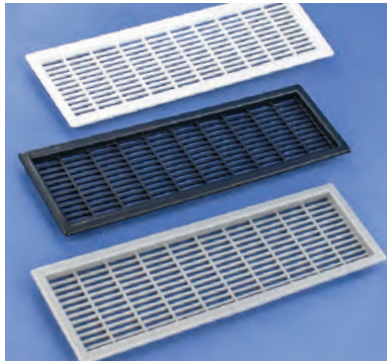

G-1970-*
Shown in
White, Black
and Silver Gray

Material: Styrene
Available in ***White (WH)**, ***Black (BK)**
or ***Silver Gray (SG)**

Designed to provide air circulation
where needed

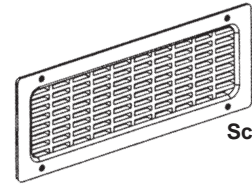

G-1971-*
Screw Mount

PART #	OVERALL SIZE	HOLE SIZE	MOUNTING TYPE
G-1970-*	2-5/8" x 8-7/8"	2-3/8" x 8-5/8"	Glue On
G-1971-*	3-9/16" x 9-11/16"	2-5/8" x 8-31/32"	Screw Mount
G-1972-*	3-9/16" x 9-11/16"	2-5/8" x 8-31/32"	Glue On
G-1975-*	2-7/8" x 8-3/4"	2-7/16" x 8-3/8"	Glue On

New

ROUND PLASTIC VENTS

Material: Styrene
Available in ***White (WH)**, ***Black (BK)**, or ***Silver (SG)**

Designed to provide
air circulation where
needed



PART #	OVERALL DIA.	DRILL HOLE DIA.	HEIGHT
G-200-*	2-3/8"	2"	5/8"
G-250-*	2-11/16"	2-1/2"	3/4"
G-300-*	3-3/8"	3"	3/4"

SUGATSUNE

New

VENTS

Material: 304 Stainless Steel
Satin finish

0.4 fine mesh wire diameter
Screws included

NSF

ROHS COMPLIANT

Round



PART #	O.D.	I.D.	THICKNESS
SAM-45	1.8125	1.641"	.2047"
SAM-60	2.359	2.109"	.2362"
SAM-85	3-344	3.062"	0.2441"

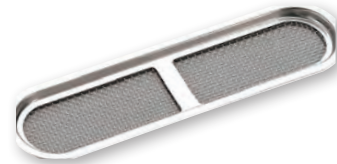

Elongated
Oval

PART #	O.D.	I.D.	THICKNESS
SAD-150	5.906" x 1.578"	5.65" x 1.339"	0.2441"
SAD-200	7.891" x 1.969"	7.638" x 1.732"	0.2441"

SUGATSUNE

New

INDUSTRIAL VENTS

Material: 316 Stainless Steel
Satin finish

Screws not included



A



B



C

D

PART #	LENGTH	WIDTH	THICKNESS
A 1-1122	8-15/32"	4-1/8"	.2362"
B 1-1212	4-17/32"	4-17/32"	.2362"
C 1-2211	8-15/32"	4-1/8"	.2362"
D 1-2222	8-15/32"	8-15/32"	.2362"

POWER STATION

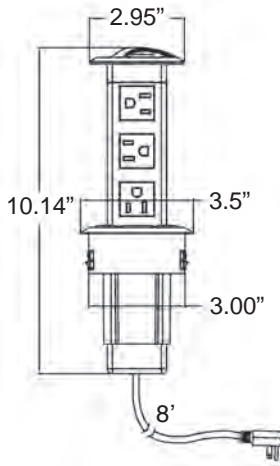

PRODUCT FEATURES:

- Black ABS construction.
- Equipped with 8 ft. of 14 AWG cable and a grounded plug.
- Works with material thickness of 3/4" to 3".
- Unit locks in its upper most position.

PART #	OUTLETS	USB DATA
PDS-96P	3	-
PDS-96US	2	2

POWER DISTRIBUTION CENTER (120V)



PRODUCT FEATURES:

- Black ABS construction.
- Compact
- Inexpensive and easy to install.
- Adaptable installation.
- Only vertical or horizontal data strip on the market today!



PRODUCT FEATURES:

- Equipped with 8 ft. of SJT 4 AWG3C heavy duty power cord.
- Attached spring clips for easy installation.
- 2 self powered USB ports, and 1 pass through USB port for data transmission.
- Bore Hole: 3-3/16" x 1-7/16" for installation.
- Overall size: 3-1/2" x 1-3/4".

PART #
PDC-96



PRODUCT FEATURES:

- Equipped with 8 ft. of AWG 14 cable and a grounded plug.
- Recess mount and secure with 2 screws. (Not Included)
- 3 AC outlets.
- 2 USB ports for charging.
- Bore hole: 7-3/8" x 1-3/4".
- Overall size: 8-1/4" x 2-1/4".

PART #
PDC-224

POWER HUB



No more reaching under your desk! Simply download music and pictures in a snap. Keep work surface clear, because all wires can be put away when task is complete.



PRODUCT FEATURES:

- Black ABS construction.
- 3 USB ports.
- 2 card readers.
- Microphone port.
- Headphone port.

PART #
PDH-96

Connects directly to your computer with a USB cord.



Top View(Closed)

3-1/2" diameter.
Touch latch to open.
Lid keeps dirt and debris from getting inside.

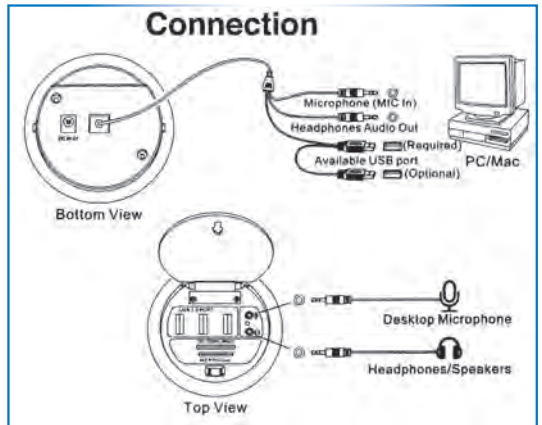

POWER - I - DOCK (120V)



All in one dock station that allows you to charge, view, listen, and synchronize your iPod / iPhone!

Note: Dock adapter maybe required for use with this unit. Refer to your devices owner manual.



Top View(Closed)

3-1/2" diameter.
Touch latch to open.
Lid keeps dirt and debris from getting inside.

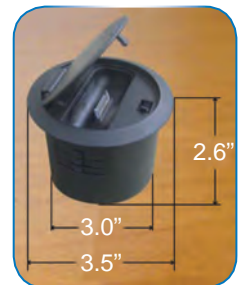

PRODUCT FEATURES:

- Black ABS construction.
- iPod / iPhone audio / video output for amplifier / tv.
- Charges iPod / iPhone.
- Synchronizes with PC / MAC.
- Apple certified "Made for iPod" and "Works with iPhone" universal dock.
- Each unit includes: 8' long x 120V power adapter.
- 8' long USB cable.
- 8' long audio / video cable.
- 30 pin connector

PART #
PDI-96

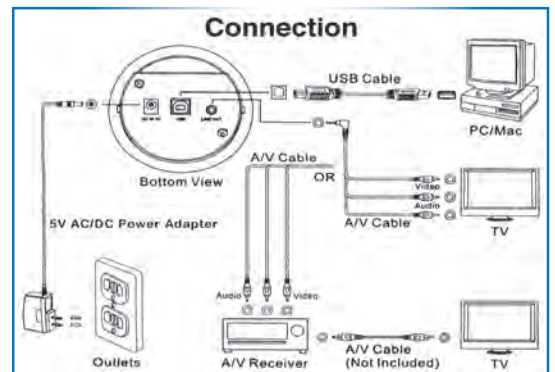

"Made for iPod" and "Made for iPhone" mean that an electronic accessory has been designed to connect specifically to iPod or iPhone, respectively, and has been certified by the developer to meet apple performance standards. Apple is not responsible for the operation of this device or its compliance with safety and regulatory standards. iPhone and iPod are trademarks of Apple Inc., registered in the U.S. and other countries.

POWER CENTER GROMMETS

Horizontal Power Docks • US 120V

- All units constructed of anodized aluminum frames and black polycarbonate and ABS interfaces.
- Equipped with 10 ft. of AWG 14 Cable and a grounded plug.
 - Resettable circuit breaker switch rated at 15A.
 - LED power master switch turns unit on and off.



Recess Power Docks

FEATURE:

- Units are easily mounted using a rectangular cut out in the desk surface.
- Secures in position with two sturdy ratchet clips.
- Can be locked in the open position at 45° or 60° to allow easy access.
- Can be closed to recessed position leaving only the cables visible from the desk surface.
- Works with maximum material 2-3/8" and a minimum of 5/8".

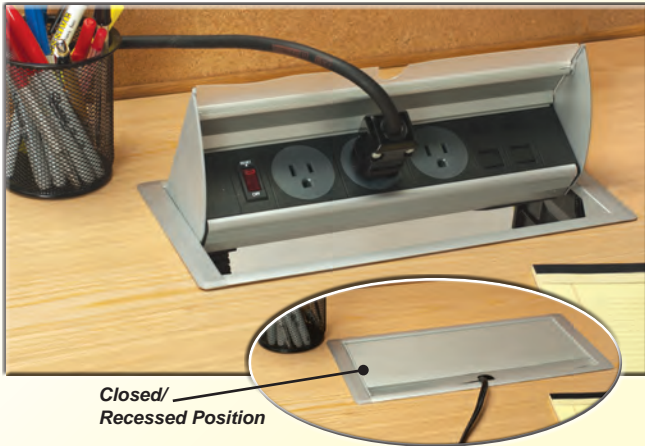

Clamp On Power Docks

FEATURE:

- Clamps onto work surface, no cut out needed.
- Portable.
- Works with maximum material 2" and a minimum of 3/8".



Recess Power Docks

PART #	OVERALL LENGTH	CUT OUT LENGTH	CUT OUT WIDTH	OUTLETS	DATA * PORTS
PDG-H-22D	8.86"	9.8"	5.2"	2	2
PDG-H-32D	10.83"	11.77"	5.2"	3	2
PDG-H-52D	14.76"	15.70"	5.2"	5	2

Clamp On Power Docks

PART #	LENGTH	WIDTH	OUTLETS	DATA * PORTS
PDG-CL-22D	8.86"	2.56"	2	2
PDG-CL-32D	10.83"	2.56"	3	2
PDG-CL-52D	14.76"	2.56"	5	2

*** DATA PORTS ARE OPEN RECEPTACLES ONLY. MUST BE FIELD WIRED!**
OTHER COLOR OPTIONS AND DATA PORT CONFIGURATIONS AVAILABLE - PLEASE INQUIRE.

POWER CENTER GROMMETS

Vertical Mount Power Docks • cUL^{us} 120V LISTED

RETRACTABLE AND CONCEALED POWER OUTLET SYSTEM.



- All units constructed of anodized aluminum with black or gray polycarbonate and ABS interfaces.
- Equipped with 10 ft. of AWG 14 Cable and a grounded plug.
- Resettable circuit breaker switch rated at 15A.
- LED power master switch turns unit on and off.
- Slim 4" diameter Fits into an (80 mm) 3.2" hole.
- Installs easily using a locking ring held firmly in place from the underside of the unit.
- Works with a maximum material thickness of 1-3/4", minimum of 5/16".
- Unit locks in its upper most position.
- Standard with a splash proof, water resistant seal when in the recessed position.

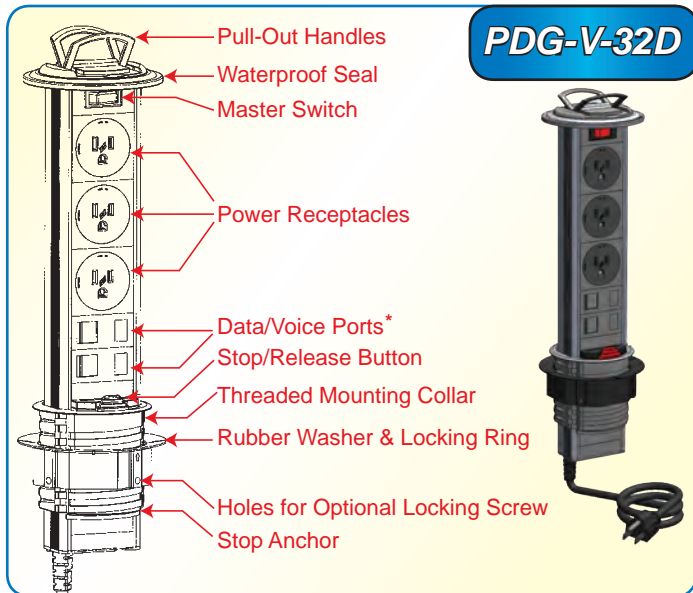

PDG-V-32D

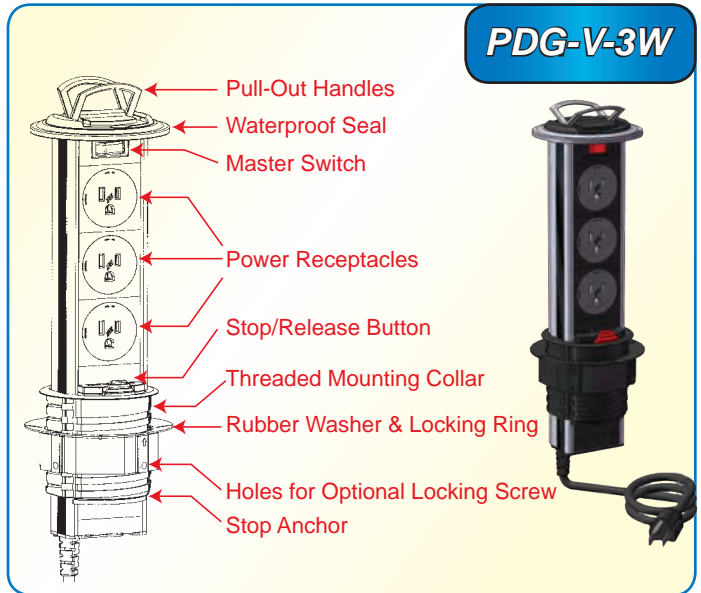

PDG-V-3W

Vertical Mount Power Docks

PART #	OVERALL LENGTH	RECESSED CLEARANCE	EXTENDED HEIGHT	DATA* OUTLETS	DATA* PORTS	COLOR
PDG-V-32D	14"	14"	9"	3	2	Anodized/Gray
PDG-V-3W	12"	12"	7"	3	-	Anodized/Black

*** DATA PORTS ARE OPEN RECEPTACLES ONLY. MUST BE FIELD WIRED!**
OTHER COLOR OPTIONS AND DATA PORT CONFIGURATIONS AVAILABLE - PLEASE INQUIRE.

FLAT SCREEN TV LIFT

Available in Silver or Black • 120V



PRODUCT FEATURES:

- The unique patented Rack & Pinion gears will provide great stability as the mechanism is engaged and moving in a linear motion.
- Simple and fast moving.
- Includes RF remote control, manual/push switch, VESA compatible mounting bracket & larger models include lid lifter.
- Ships in one carton.
- Assembly required - simply install in cabinet and plug & play.
- Not just for TV's...suitable for many other applications.
- All units offer reverse function lift.



PART #	COLOR	MINIMUM HEIGHT	MAXIMUM HEIGHT	TRAVEL	DEPTH BEHIND TV	WEIGHT CAPACITY	REVERSE FUNCTION WEIGHT CAPACITY
WT-4056	Silver	25.5"	43.5"	18"	2"	110 lbs.	45 lbs.
WT-700	Black	23.5"	51"	27.5"	2-13/16"	145 lbs.	60 lbs.
WT-4050	Black	34"	63.5"	29.5"	2-3/4"	145 lbs.	60 lbs.
WT-1000	Black	29.5"	69"	39.375"	2-13/16"	145 lbs.	60 lbs.

NOTE: Reverse function allows lifts to be used in both ascending & descending applications. WT-700 & WT-1000 have a safety stop feature that will engage in both applications.



LCD WALL MOUNTS

POWDER COATED STEEL • POWDERED COATED CAST ALUMINUM

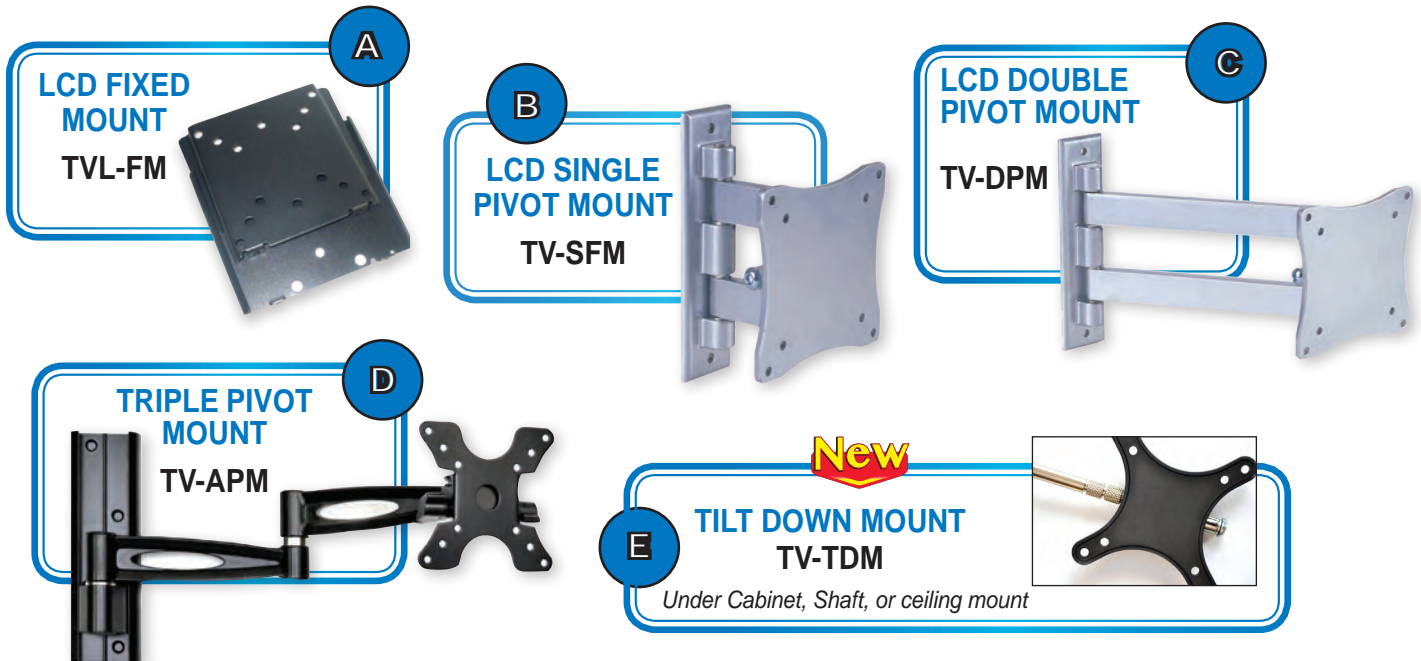

	PART #	TV SIZE	WEIGHT CAPACITY	FINISH	PROJECTION	PIVOT	VESA	PLATE SIZE
A	TVL-FM	12"-42"	70 lbs	Powder Coated Black/Steel	1/2" off Wall	N/A	75 x 75 & 100 x 100	5-1/2" x 5"H
B	TV-SFM	12"-27"	25 lbs	Powder Coated Silver/Cast Aluminum	2" (Arm can extend 1")	160° Horizontally 45° Vertically	75 x 75 & 100 x 100	1-3/4" x 6-3/4"H
C	TV-DPM	12"-27"	27 lbs	Powder Coated Silver/Cast Aluminum	1-1/2" to 9-1/2"	180° Horizontally 45° Vertically	75 x 75 & 100 x 100	1-3/4" x 6-3/4"H
D	TV-APM	15"-30"	30 lbs	Powder Coated Black, Aluminum & Steel	3" -16-1/2"	180° Horizontally 7 degrees up 15 degrees down	45 x 45, 75 x 75 & 100 x 100	2-1/2" x 8-1/4"H
E	TV-TDM	12"-24"	25 lbs	Powder Coated Black & Chrome Cast Aluminum	9" Rod Extension	Drops down 105° and swivels 180°	75 x 75 & 100 x 100	2-1/4" x 5-3/4"H

PLASMA / LCD FIXED MOUNT FOR FLAT PANEL TV'S

POWDER COATED BLACK/HEAVY GAUGE STEEL

This universal mounting system fits most large flat panel plasma and LCD TVs. Mounts flat to the wall. Made of steel. Locks in place! VESA * compliant.

- Holds 30" - 63" TVs, up to 165 lbs.
- Features locking cleats to keep TV safe and secure to wall.
- Its low profile allows TV to be mounted only 1.25" off the wall.
- Mounting plate is 32" wide.
- All mounting hardware included.

PART# TVPL-FM

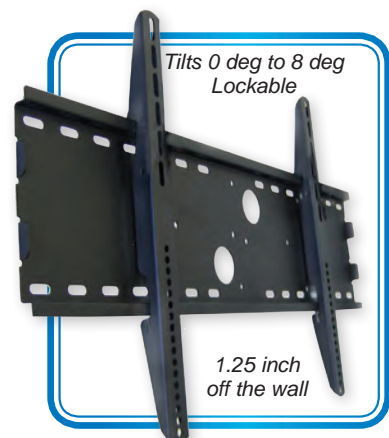

* VESA is a registered trademark (video electronics, standards association)

It is recommended to always mount into a wood or metal stud using appropriate anchors.

ANGLED POWER STRIPS (120V)

BY ELIMINATING CUTOUTS SHOW OFF YOUR BACKSPLASH OR SHOWCASE WITHOUT THE INTERRUPTION OF OBTRUSIVE OUTLETS AND EXTENSION CORDS!



IDEAL FOR KITCHENS, BATHROOMS, DISPLAYS AND SHOWCASES.



STANDARD OUTLET



APS Series

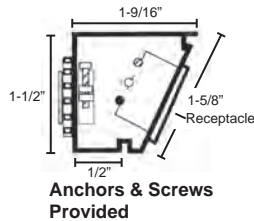

TAMPER RESISTANT OUTLET



TR Series

Meets 2008 National Electric Code

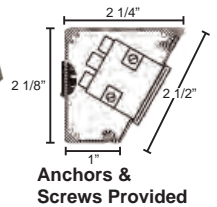

***Finish**

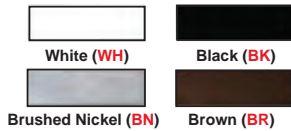

Receptacle Colors (15 AMP)



***Finish**

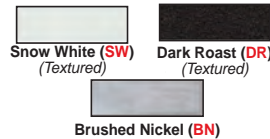

Receptacle Colors (15 AMP)



WIRE ENTRY

When purchasing 12" or 18" APS series you must specify left or right wire entry.

L = Left Wire Entry

R = Right Wire Entry

All other sizes have a knockout on either side, so that wiring can be done in the field.

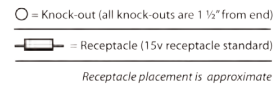
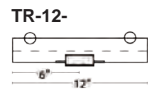
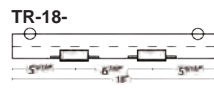
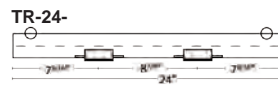
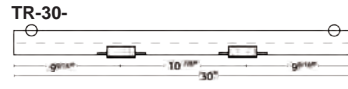
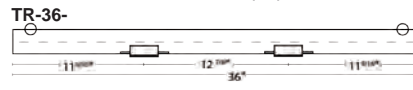
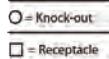
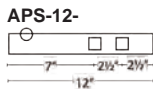
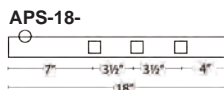
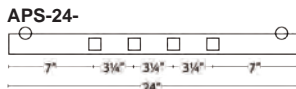
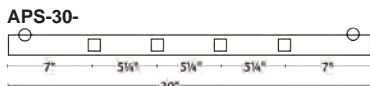
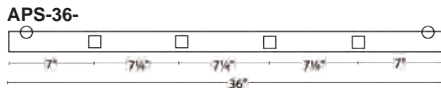

WIRE ENTRY

Knockouts are located on either side, so that wiring can be done in the field.

APS SERIES

PART #	*FINISH	RECEPTACLE	LENGTH	# OF OUTLETS
APS-12* (L OR R)	BK, BR, BN	Black	12"	2
APS-12* (L OR R)	WH	White	12"	2
APS-18* (L OR R)	BK, BR, BN	Black	18"	3
APS-18* (L OR R)	WH	White	18"	3
APS-24*	BK, BR, BN	Black	24"	4
APS-24*	WH	White	24"	4
APS-30*	BK, BR, BN	Black	30"	4
APS-30*	WH	White	30"	4
APS-36*	BK, BR, BN	Black	36"	4
APS-36*	WH	White	36"	4

TR SERIES

PART #	*FINISH	RECEPTACLE	LENGTH	# OF OUTLETS
TR-12*	BN	Gray	12"	2
TR-12*	DR	Black	12"	2
TR-12*	SW	White	12"	2
TR-18*	BN	Gray	18"	4
TR-18*	DR	Black	18"	4
TR-18*	SW	White	18"	4
TR-24*	BN	Gray	24"	4
TR-24*	DR	Black	24"	4
TR-24*	SW	White	24"	4
TR-30*	BN	Gray	30"	4
TR-30*	DR	Black	30"	4
TR-30*	SW	White	30"	4
TR-36*	BN	Gray	36"	4
TR-36*	DR	Black	36"	4
TR-36*	SW	White	36"	4

Other lengths, and finish/receptacle combinations are available. Please inquire.

It is recommended that all electrical products be installed by a licensed electrician.

ADJUSTMENT KNOBS

• **COLOR - BLACK**

- Constructed of durable nylon or polypropylene knobs with zinc plated steel studs and inserts.
- Designed for economical, light-duty securing and clamping applications.
- Resistant to water and solvents.



STYLE	PART #	DIAMETER	THREAD SIZE	TYPE	STUD LENGTH	MATERIAL
1	S7-F13BK	1.125"	1/4-20	Male	.75"	Nylon
	S7-F10BK	1.575"	5/16-18	Female	N/A	Polypropylene
	S7-F15BK	2.36"	5/16-18	Female	N/A	Polypropylene
	S7-F14BK	1.575"	1/4-20	Male	1.375"	Polypropylene
	S7-F17BK	1.575"	5/16-18	Male	.50"	Polypropylene
	S7-F18BK	1.575"	5/16-18	Male	.75"	Polypropylene
	S7-F19BK	1.575"	5/16-18	Male	1.375"	Polypropylene
	S7-F20BK	2.36"	5/16-18	Male	.50"	Polypropylene
2	S7-F21BK	2.36"	5/16-18	Male	.75"	Polypropylene
	S7-N12BK	1.575"	1/4-20	Female	N/A	Polypropylene
	S7-N13BK	2.36"	5/16-18	Female	N/A	Polypropylene
	S7-N22BK	1.575"	1/4-20	Male	.75"	Polypropylene
	S7-N23BK	1.575"	1/4-20	Male	1.375"	Polypropylene
	S7-N24BK	1.575"	5/16-18	Male	.50"	Polypropylene
	S7-N25BK	1.575"	5/16-18	Male	.75"	Polypropylene
	S7-N26BK	1.575"	5/16-18	Male	1.00"	Polypropylene
3	S7-N27BK	1.575"	5/16-18	Male	1.375"	Polypropylene
	S7-N28BK	2.36"	5/16-18	Male	.75"	Polypropylene
	S7-N29BK	2.36"	5/16-18	Male	1.50"	Polypropylene
	S7-K14BK	1.575"	5/16-18	Female	N/A	Polypropylene
	S7-K15BK	2.36"	5/16-18	Female	N/A	Polypropylene
	S7-A30BK	1.575"	1/4-20	Male	.75"	Polypropylene
	S7-A31BK	1.575"	1/4-20	Male	1.375"	Polypropylene
	S7-A32BK	1.575"	5/16-18	Male	.75"	Polypropylene
4	S7-A33BK	1.575"	5/16-18	Male	.50"	Polypropylene
	S7-A34BK	1.575"	5/16-18	Male	1.00"	Polypropylene
	S7-A35BK	1.575"	5/16-18	Male	1.50"	Polypropylene
	S7-A36BK	2.36"	5/16-18	Male	.75"	Polypropylene
	S7-A37BK	2.36"	5/16-18	Male	1.50"	Polypropylene
	S7-C21BK	1.25"	1/4-20	Male	.75"	Nylon
5	S7-I31BK	2.50"	1/4-20	Female	N/A	Nylon
6	S7-J21BK	1.375"	1/4-20	Male	.75"	Nylon

SHELF RESTS

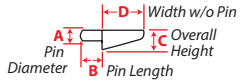

To calculate shelf length, use the following formula: $\text{inside cabinet width} - \text{shelf clearance} = \text{shelf size}$

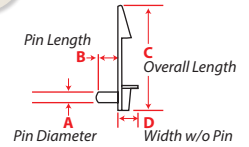

PLASTIC SHELF RESTS

LOCKING SHELF RESTS (Fluted)

Designed to hold shelves securely in place



	PART #	COLOR	MATERIAL	A	B	C	D	SHELF THICKNESS	SHELF CLEARANCE
1	JPE-301-12-010-1	White	ABS	1/4"	5/16"	2-1/4"	1/2"	1/2"	1/4"
	JPE-301-34-010-1	White	ABS	1/4"	5/16"	2-1/4"	1/2"	3/4"	1/4"
	JPE-301-58-010-1	White	ABS	1/4"	5/16"	2-1/4"	1/2"	5/8"	1/4"
2	R25-192-750WH	White	H.D.P.E	5mm	5/16"	2-1/4"	1/2"	3/4"	7/32"
	R25-604-500-CL	Clear	Polycarbonate	1/4"	5/16"	1-3/4"	1/2"	1/2"	7/32"
	R25-604-625-CL	Clear	Polycarbonate	1/4"	5/16"	1-7/8"	1/2"	5/8"	7/32"
3	R25-604-750-CL	Clear	Polycarbonate	1/4"	5/16"	2"	1/2"	3/4"	7/32"
	R25-805-500-CL	Clear	Polycarbonate	5mm	1/4"	1-3/4"	1/2"	1/2"	7/32"
	R25-805-625-CL	Clear	Polycarbonate	5mm	1/4"	1-7/8"	1/2"	5/8"	7/32"
4	R25-805-750-CL	Clear	Polycarbonate	5mm	1/4"	2"	1/2"	3/4"	7/32"
	OPHS-1826-BK	Black	Nylon 6	5mm	15/64"	1-11/16"	1/4"	1/2"	3/16"
	OPHS-1826-BR	Brown	Nylon 6	5mm	15/64"	1-11/16"	1/4"	1/2"	3/16"
5	OPHS-1826-WH	White	Nylon 6	5mm	15/64"	1-11/16"	1/4"	1/2"	3/16"
	OPHS-1826-CL	Clear	Polycarbonate	5mm	15/64"	1-11/16"	1/4"	1/2"	3/16"
	OPHS-1828-CL	Clear	Polycarbonate	5mm	15/64"	1-11/16"	1/4"	5/8"	3/16"
6	OPHS-1829-CL	Clear	Polycarbonate	5mm	15/64"	1-11/16"	1/4"	3/4"	3/16"
	R25-244-625WH	White	H.D.P.E	5mm	3/8"	1-5/8"	1/2"	5/8"	7/32"
	R25-244-750WH	White	H.D.P.E	5mm	3/8"	1-7/8"	1/2"	3/4"	7/32"
	R25-244-750BE	Beige	H.D.P.E	5mm	3/8"	1-7/8"	1/2"	3/4"	7/32"



INSTITUTIONAL LOCKING SHELF REST (Smooth)

- Over 300 pound shear test
- Supports shelf loads over 500 lbs
- Ideal for commercial or institutional furniture
- For extra support, this can be screwed to the side panel of the cabinet
- Can withstand earthquakes

PART #	COLOR	MATERIAL	A	B	C	D	SHELF THICKNESS	SHELF CLEARANCE
R25-BGD-CL	Clear	Polycarbonate	Twin 5mm	5/16"	2-1/2"	1/2"	3/4" or 1"	1/4"



SPOON SHAPE SHELF REST (Fluted)

PART #	COLOR	MATERIAL	A	B	C	D	SHELF THICKNESS	SHELF CLEARANCE
R25-171CL	Clear	Polycarbonate	1/4"	5/16"	1/2"	1/2"	3/16"	



SPOON SHAPE SHELF REST w/SMOOTH PIN for SOFT WOOD (Smooth)

PART #	COLOR	MATERIAL	A	B	C	D	SHELF THICKNESS	SHELF CLEARANCE
R25-170CL	Clear	Polycarbonate	1/4"	13/32"	1/2"	1/2"	3/16"	

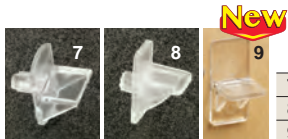

STANDARD DUTY SHELF RESTS (Fluted)

PART #	COLOR	MATERIAL	A	B	C	D	SHELF THICKNESS	SHELF CLEARANCE
7 R25-470CL	Clear	Lexan	1/4"	11/32"	3/8"	3/8"	7/32"	
8 R25-350CL	Clear	Lexan	1/4"	5/16"	1"	1/2"	7/32"	
9 R25-241CL	Clear	Polycarbonate	5mm	1/4"	1"	1/2"	7/32"	



EXTRA LONG SHELF REST (Fluted)

PART #	COLOR	MATERIAL	A	B	C	D	SHELF THICKNESS	SHELF CLEARANCE
R25-471CL	Clear	Polycarbonate	1/4"	3/8"	1/2"	1"	5/64"	



MEDICINE CABINET SHELF REST (Smooth)

Accepts up to 1/8" shelf and designed so that the shelf will not shimmy

PART #	COLOR	MATERIAL	A	B	C	D	SHELF THICKNESS	SHELF CLEARANCE
R25-CK	Clear	Polycarbonate	5MM	5/16"	1/2"	1/2"	1/8	3/16"



SMOOTH PIN SHELF REST IDEAL FOR SOFT WOOD (Smooth)

PART #	COLOR	MATERIAL	A	B	C	D	SHELF THICKNESS	SHELF CLEARANCE
R25-809WH	White	H.D.P.E.	5MM	3/8"	1/2"	1/2"	5/64"	

IF YOU ARE LOOKING TO COVER SHELF REST HOLES, SEE PAGE 290 FOR OUR FASTCAP™ SELECTIONS

SHELF RESTS

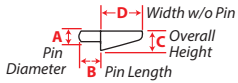

To calculate shelf length, use the following formula: $\text{inside cabinet width} - \text{shelf clearance} = \text{shelf size}$

PLASTIC SHELF RESTS

STEEL PIN SHELF REST w/PLASTIC HOUSING (Smooth)



PART #	COLOR	MATERIAL	A	B	C	D	SHELF CLEARANCE
R25-728CL	Clear	Brite Nickel Pin w/Polycarbonate Housing	5MM	1/4"	1-1/4"	3/8"	3/16"

2 PIECE 32mm SHELF LOCKING SYSTEM

Holds shelf in place



PART #	COLOR	MATERIAL	A
SH-103113	White	Nylon	5MM

GLASS SHELF RESTS



PART #	COLOR	MATERIAL	A	B	C	D	SHELF THICKNESS	SHELF CLEARANCE
R25-605CL	Clear	H.D.P.E.	1/4"	3/8"	7/8"	1/2"	3/16"	1/8"
R25-606CL	Clear	H.D.P.E.	1/4"	3/8"	7/8"	1/2"	1/4"	1/8"
R25-806CL	Clear	H.D.P.E.	5mm	3/8"	7/8"	1/2"	1/4"	1/8"



PART #	FINISH	MATERIAL	A	B	C	D	SHELF CLEARANCE
SH-138	Brite Nickel	Nickel Plated w/PVC Nonskid Pad	5mm	5/16"	1"	11/16"	1/8"

STEEL SHELF RESTS

SPOON SHELF RESTS

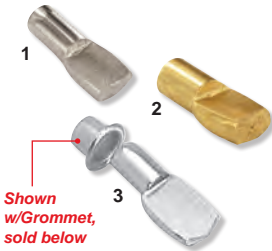

	PART #	FINISH	MATERIAL	A	B	C	D	SHELF CLEARANCE
1	R25-228-NI	Bright Nickel	Steel	5MM	5/16"	3/4"	7/16"	1/8"
	R25-228-BRS	Bright Brass	Steel	5MM	5/16"	3/4"	7/16"	1/8"
	R25-228-BZ	Bronze	Steel	5MM	5/16"	3/4"	7/16"	1/8"
2	R25-128-NI	Bright Nickel	Steel	1/4"	3/8"	7/8"	1/2"	1/8"
	R25-128-BRS	Bright Brass	Steel	1/4"	3/8"	7/8"	1/2"	1/8"
3	R25-450NP-SS	Bright Nickel	Steel	7MM	3/8"	15/16"	9/16"	1/8"
	R25-450BRS-SS	Bright Brass	Steel	7MM	3/8"	15/16"	9/16"	1/8"

STEEL SHELF RESTS w/SOFT BROWN PVC SLEEVE



PART #	FINISH	MATERIAL	A	B	C	D	SHELF CLEARANCE
R25-300-NI	Bright Nickel	Steel w/Brown PVC Sleeve	1/4"	7/16"	1-1/4"	3/4"	1/8"
R25-300-BR	Bright Brass	Steel w/Brown PVC Sleeve	1/4"	7/16"	1-1/4"	3/4"	1/8"
R25-305-NI	Bright Nickel	Steel w/Brown PVC Sleeve	5mm	7/16"	1-1/4"	3/4"	1/8"
R25-305-BR	Bright Brass	Steel w/Brown PVC Sleeve	5mm	7/16"	1-1/4"	3/4"	1/8"

ZINC DIECAST SPOON SHELF RESTS



PART #	FINISH	MATERIAL	A	B	C	D	SHELF CLEARANCE
SH-700Z	Bright Nickel	Zinc Diecast	1/4"	7/16"	1"	5/8"	1/8"
SH-700B	Bright Brass	Zinc Diecast	1/4"	7/16"	1"	5/8"	1/8"

STRAIGHT DOWEL SHELF RESTS



PART #	FINISH	MATERIAL	A	B	C	D	SHELF CLEARANCE
PSR-02CH	Bright Nickel	Steel	5mm	5/16"	11/16"	N/A	1/8"
PSR-02BR	Bright Brass	Steel	5mm	5/16"	11/16"	N/A	1/8"

HOLE GROMMETS

- Designed to be used in shelf rest holes as a decorative accent
- This accepts a specific size shelf rest, therefore the drill hole will need to be slightly larger

NO BROKEN BOXES- 1000 pcs. minimum order

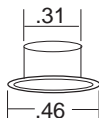

PART #	FINISH	MATERIAL	PIN DIAMETER	OVERALL SIZE
R25-450NP-GT	Bright Nickel	Steel	7mm	1/2" Dia. x 1/4" High
R25-450BRS-GT	Bright Brass	Steel	7mm	1/2" Dia. x 1/4" High
R25-128BRS-GT	Bright Brass	Steel	1/4"	5/16" Dia. x 1/4" High
R25-128NI-GT	Bright Nickel	Steel	1/4"	5/16" Dia. x 1/4" High

IF YOU ARE LOOKING TO COVER SHELF REST HOLES, SEE PAGE 290 FOR OUR FASTCAP™ SELECTIONS

EXCELLENT FOR GLASS TABLES, CABINET DOOR, LIDS & DRAWERS!

Bumpson products are made of durable, resilient polyurethane polymer formulated especially for its unique high coefficient of friction, slip-resistant, non-marring features. An aggressive, high tack pressure sensitive adhesive protected with any easy release liner makes application fast & easy. Use to prevent slamming, nicking, scuffing, sliding, vibration or noise. Clear bumpsons become virtually invisible, since the clarity of the polyurethane bumpers enables them to transmit any color they are placed on.

3M™
AUTHORIZED
DISTRIBUTOR

- NON-SKID
- NON-MARRING
- CRACK RESISTANT
- SELF ADHESIVE BACKING

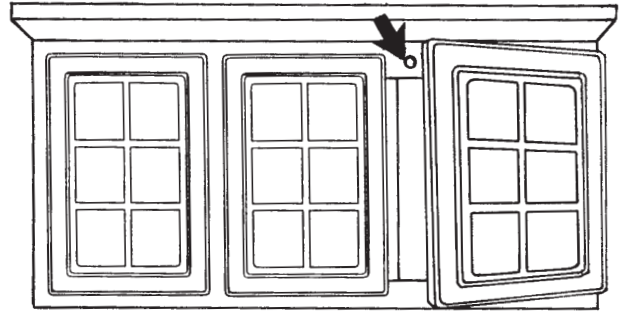

CLEAR

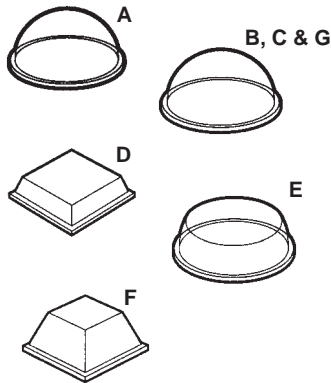

DIMENSIONS:

PART #		DIMENSIONS:		STYLE	COLOR
		ENGLISH +/-0.02 in.	METRIC +/-0.5 mm		
A SJ-5302	WIDTH: HEIGHT:	0.312 0.085	7.9 2.2	Bell Shaped	Clear
B SJ-5303	WIDTH: HEIGHT:	0.44 0.20	11.1 5.0	Hemisphere	Clear
C SJ-5306	WIDTH: HEIGHT:	0.375 0.150	9.5 3.8	Hemisphere	Clear
D SJ-5308	WIDTH: HEIGHT:	0.50 0.12	12.7 3.1	Tapered Square	Clear
E SJ-5312	WIDTH: HEIGHT:	0.50 0.14	12.7 3.5	Cylindrical	Clear
F SJ-5318	WIDTH: HEIGHT:	0.50 0.23	12.7 5.8	Tapered Square	Clear
G SJ-5382	WIDTH: HEIGHT:	0.250 0.075	6.4 1.9	Hemisphere	Clear

QUIET CLEAR SERIES

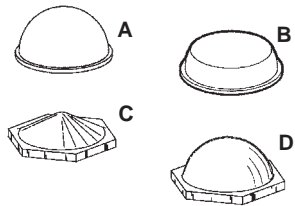

DIMENSIONS:

PART #		DIMENSIONS:		STYLE	COLOR
		ENGLISH +/-0.02 in.	METRIC +/-0.5 mm		
A SJ-6506	DIAMETER: HEIGHT:	0.375 0.150	9.5 3.8	Hemispherical	Clear
B SJ-6512	DIAMETER: HEIGHT:	0.500 0.140	12.7 3.5	Cylindrical	Clear
C SJ-6553	WIDTH: HEIGHT:	0.433 0.120	11.0 3.05	Hexagonal Cone	Clear
D SJ-6561	LENGTH: HEIGHT:	0.433 0.150	11.0 3.8	Hexagonal Hemisphere	Clear

BRIGHT WHITE



DIMENSIONS:

PART #		DIMENSIONS:		STYLE	COLOR
		ENGLISH +/-0.02 in.	METRIC +/-0.5 mm		
A SJ-5412	WIDTH: HEIGHT:	0.507 0.14	12.7 3.6	Cylindrical	Bright White

* THE ITEMS LISTED AS WHITE ARE AN OFF WHITE COLOR. THE BRIGHT IS PURE WHITE IN COLOR.

EXCELLENT FOR GLASS TABLES, CABINET DOOR, LIDS & DRAWERS!

COLORS

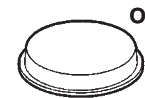
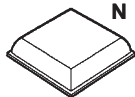
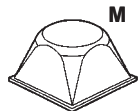
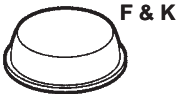
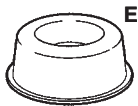
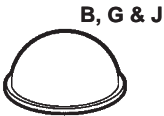

DIMENSIONS:

PART #		DIMENSIONS:		STYLE	COLOR	
		ENGLISH +/-0.02 in.	METRIC +/-0.5 mm			
A SJ-5001BK	WIDTH:	0.50	12.7	Cylindrical	Black	
	HEIGHT:	0.14	3.5			
B SJ-5003WH SJ-5003GY SJ-5003BK	WIDTH:	0.44	11.1	Hemisphere	*White Grey Black	
	HEIGHT:	0.20	5.0			
C SJ-5007BK	WIDTH:	0.40	10.2	Tapered Square	Black	
	HEIGHT:	0.12	2.5			
D SJ-5008WH SJ-5008GY SJ-5008BK	WIDTH:	0.50	12.7	Tapered Square	*White Grey Black	
	HEIGHT:	0.12	3.1			
E SJ-5009WH SJ-5009GY SJ-5009BK	WIDTH:	0.88	22.3	Circular Depressed	*White Grey Black	
	HEIGHT:	0.40	10.1			
F SJ-5012WH SJ-5012GY SJ-5012BR SJ-5012BK	WIDTH:	0.50	12.7	Cylindrical	*White Grey Brown Black	
	HEIGHT:	0.14	3.5			
G SJ-5017WH SJ-5017BK	WIDTH:	0.75	19.0	Hemisphere	*White Black	
	HEIGHT:	0.38	9.6			
H SJ-5018WH SJ-5018GY SJ-5018BR SJ-5018BK	WIDTH:	0.50	12.7	Tapered Square	*White Grey Brown Black	
	HEIGHT:	0.23	5.8			
I SJ-5023WH SJ-5023GY SJ-5023BK	WIDTH:	0.81	20.5	Tapered Square	*White Grey Black	
	HEIGHT:	0.30	7.6			
J SJ-5027WH SJ-5027GY SJ-5027BK	WIDTH:	0.63	16.0	Hemisphere	*White Grey Black	
	HEIGHT:	0.31	7.9			
K SJ-5076BK	WIDTH:	.315	8.0	Cylindrical	Black	
	HEIGHT:	0.11	2.8			
L SJ-5508BK	WIDTH:	0.50	12.7	Tapered Square	Black	
	HEIGHT:	0.12	3.1			
M SJ-5514WH SJ-5514GY SJ-5514BK	WIDTH:	0.81	20.6	Tapered Square	*White Grey Black	
	HEIGHT:	0.52	13.1			
N SJ-5705BK	WIDTH:	1.25	31.75	Tapered Square	Black	
	HEIGHT:	0.24	6.1			
O SJ-5744BK	WIDTH:	0.75	19.1	Cylindrical	Black	
	HEIGHT:	0.16	4.1			

HEAVY DUTY



DIMENSIONS:

PART #		DIMENSIONS:		STYLE	COLOR
		ENGLISH +/-0.02 in.	METRIC +/-0.5 mm		
SJ-5532BR	WIDTH:	1.88	47.7	Circular Depressed	Brown Black
	HEIGHT:	.66	16.7		

CONTINUOUS BUMPER - 50 FT. COILS

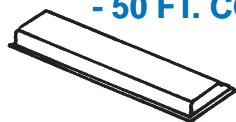

DIMENSIONS:

PART #		DIMENSIONS:		STYLE	COLOR
		ENGLISH +/-0.02 in.	METRIC +/-0.5 mm		
SJ-5510BK	WIDTH:	0.50	12.7	Strip	Black
	HEIGHT:	0.15	3.8		

* THE ITEMS LISTED AS WHITE ARE AN OFF WHITE COLOR. THE BRIGHT IS PURE WHITE IN COLOR.

3M™ BUMPON™ PROTECTIVE PRODUCTS

EXCELLENT FOR GLASS TABLES, CABINET DOOR, LIDS & DRAWERS!

TOP HAT

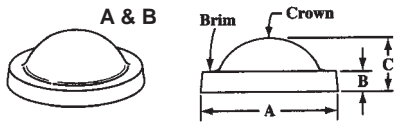

PART #	DIMENSIONS:			STYLE	COLOR
	A	B	C		
A SJ-6115	.625	.093	.187	Flat Top Hat	Black
B SJ-6125	.625	.093	.187	Round Top Hat	Black

EASY SLIDE BUMPER

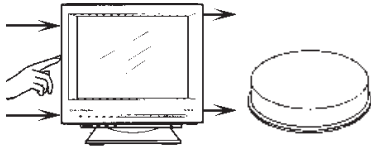

- NON-MARRING & NON-STAINING
- CRACK RESISTANT
- SELF ADHESIVE BACKING
- LOAD BEARING - UP TO 40 LBS. PER BUMPER

PART #	DIMENSIONS:	ENGLISH	METRIC	STYLE	COLOR
		+/-0.02 in.	+/-0.5 mm		
SJ-6344BK	WIDTH:	.75	4.1	Cylindrical	Black
	HEIGHT:	.16	19.1		

POLYURETHANE ADHESIVE BUMPERS



All bumpers stocked in clear.
Please inquire for colors. Colors sold in full cases only.
1000 PIECE MINIMUM ORDER

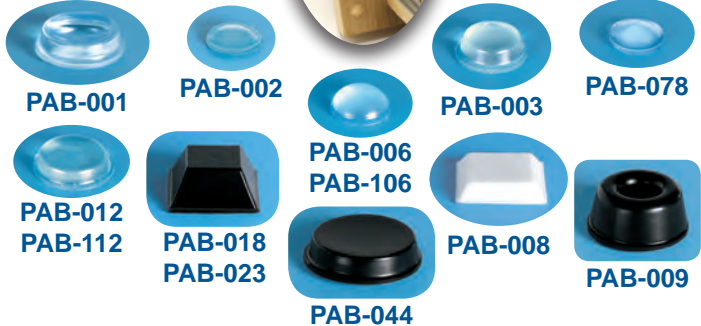

PART #	WIDTH	HEIGHT	CASE QUANTITY
PAB-001CL	.500"	.140"	5000
PAB-002CL	.312"	.085"	5400
PAB-003CL	.440"	.200"	5082
PAB-006CL	.375"	.150"	7200
PAB-008CL	.500"	.120"	5000
PAB-009CL	.880"	.400"	1440
PAB-012CL	.500"	.140"	5000
PAB-018CL	.500"	.230"	5000
PAB-023CL	.810"	.300"	2646
PAB-044CL	.750"	.160"	2450
PAB-078CL	.400"	.118"	7200
SOFT SERIES - Softer bumper for extra sound deadening properties			
PAB-106CL	.375"	.150"	7200
PAB-112CL	.500"	.140"	5000

NON-SKID PADS

EMBOSSED BLACK

Our Non-Skid Pads consist of specially formulated thermoplastic rubber material fused to cross-linked polyethylene foam with adhesive backing.

- HIGH DURABILITY
- NON-MARRING
- ABRASIVE RESISTANCE
- CHEMICAL & WATER RESISTANT

Kitchen Appliances
Office & Desk Accessories
Computer Terminal Equipment
Medical Devices

**DIE-CUTTING AVAILABLE,
PLEASE INQUIRE.**



50 FT.
ROLLS



PART #	DESCRIPTION
NS-1600-4	1/2" Wide x 1/8" Thick
NS-1600-2	1/2" Wide x 1/16" Thick
NS-3200-4	1" Wide x 1/8" Thick
NS-3200-2	1" Wide x 1/16" Thick

PICTURE	PART #	DESCRIPTION
	NS-0016-4	1/2" Dia. x 1/8" Thick
	NS-0016-2	1/2" Dia. x 1/16" Thick
	NS-3232-4	1" x 1" x 1/8" Thick
	NS-3232-2	1" x 1" x 1/16" Thick
	NS-3264-4	1" x 2" x 1/8" Thick
	NS-3264-2	1" x 2" x 1/16" Thick
	NS-3296-4	1" x 3" x 1/8" Thick
	NS-3296-2	1" x 3" x 1/16" Thick

ADJUSTABLE CABINET LEGS

METAL LEG SETS

New



- Adjustable from 4" to 6-1/2"
- Comes packed in sets of 4 legs, 4 black plastic top sockets with bolts, 2 toe kick clips (screw mount or groove mount) 4 white & 4 almond cover caps
- 330 lb. weight capacity per leg

PART #	TOE KICK CLAMP STYLE
CLG-400S	Screw Mount
CLG-400G	Groove Mount

ABS PLASTIC LEG SETS



CLG-445A

- Adjustable from either 4-1/2 x 7 or 3.68 to 6.28
- Comes packed in sets of 4 black legs, 4 top sockets & 2 black toe clips
- 330 lb - 750 lb, load capacity per leg



OPHS-2609

PART #	HEIGHT ADJUSTMENT	MATERIAL	LOAD CAPACITY PER LEG	TOE KICK CLAMP STYLE
CLG-445A	4-1/2"-7"	ABS	350 lbs.	Adhesive
OPHS-2609	3.68"-6.28"	Polystyrene	188 lbs.	Screw

A LA CARTE CABINET LEGS & ACCESSORIES



ABS PLASTIC CABINET LEG

- Two piece white leveling leg (foot & shaft)
- 330 lb load capacity per leg

PART #	HEIGHT ADJUSTMENT
CLG-423-4	4" - 4-5/8"
CLG-423-6	6" - 6-5/8"

ABS PLASTIC TOP SOCKETS

- White
- Bolt included

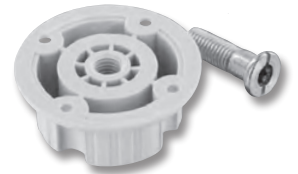

PART #
CLG-841

2-FINGER TOE KICK CLIPS

MATERIAL: ABS PLASTIC



- Metal Fingers to ensure long lasting connection to leg

PART #	CLAMP STYLE
CLG-228A	Adhesive Mount
CLG-228G	Groove Mount
CLG-228S	Screw Mount

PLASTIC CABINET COMPONENTS

CORNER PROTECTORS

- Designed to protect vulnerable corners of mirrors, cabinet doors and picture frames

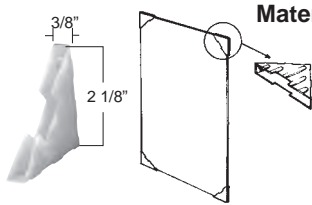

Material: H.D.P.E.

For 3/16" or 1/4" Glass

PART # COLOR
GC-215 White

Material: H.D.P.E.

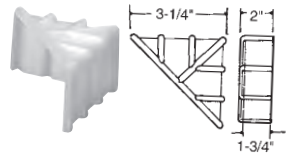

PART # COLOR
CP-448 White

Material: Polyethylene

New

Accept Up To 1/2" Thick Material

PART # COLOR
GC-500 White



GLUE AND STAPLE BLOCKS

- Stapled inside the cabinet to hold the cabinet backs and sides together during the assembly process

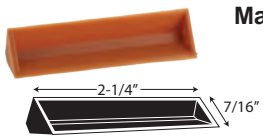

Material: Styrene

250 Pcs. per Box

PART # COLOR
R44-445 Beige

Material: Polyethylene

New

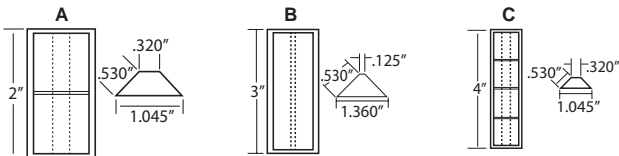
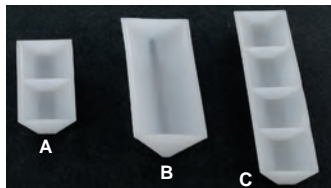

PART # COLOR SIZE

A	R44-250	White	2"
B	R44-300	White	3"
C	R44-400	White	4"

FLOOR GLIDE AND PROTECTOR

New

Material: Polyethylene

- Staple to underside of cabinets or furniture
- Prevents damage to cabinets during handling and transportation.
- 1/4" (60mm) of clearance between cabinet and floor

PART # COLOR SIZE
R32-737 Natural 1-1/2"

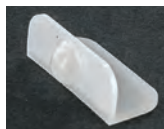

CORNER BRACES

- Designed to strengthened and stabilize the cabinet during the manufacturing process
- To be installed in the top section of the base cabinet and aid in securing the countertop

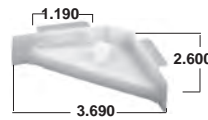

Material: H.D.P.E.

PART # COLOR
R44-370 White

Material: H.D.P.E.



PART # COLOR
CB-2500 White

Material: Polyethylene

New

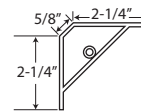
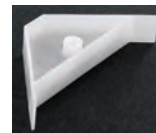

PART # COLOR
CB-920 White

PLASTIC WEDGE & DOOR STOP

Material: H.D.P.E.

- Wedges are used to assure proper positioning of hinged doors
- Wedges guide doors when case is out of alignment
- Neat appearance, assures doors stay closed, economical & does not require finishing
- May be installed at top or bottom of all doors, side of single doors.

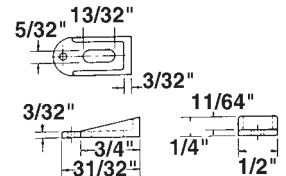

PART # COLOR
R50-441DBR Dark Brown
R50-441WH White

TOE KICK BRACKET

New

Material: Styrene

- Designed to stabilize and strengthen the toe kick area of the cabinet
- Staple mount

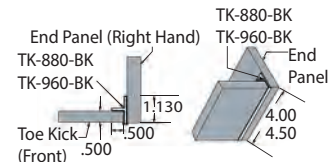

Accept Up To 1/2" Thick Material

PART # COLOR INSET
TK-880BK Black 4"
TK-960BK Black 4-1/2"

BREAK-AWAY PLASTIC FURNITURE WEDGE

Material: Polystyrene

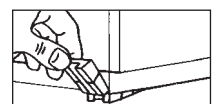
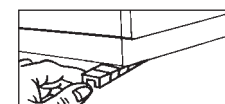

PART # COLOR
58-076-400 Dark Brown

RUBBER-SEALS® w/ PEEL & STICK

114-113 (black only)
500 Ft. Coils w/Adhesive

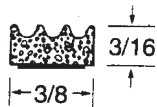

COLOR
Black

Black
(White where noted)
Sponge Rubber

Recommended Temperature
Range for General
Product Applications
-20° through +150°

MANY APPLICATIONS:

- Cabinets
- Doors
- Windows
- Camper Shell Doors
- Skylights
- Sunroofs
- and many others

114-1333 (black)
114-1333-OW (off white)
500 Ft. Coils w/Adhesive



COLOR
Black
White

114-114 (black only)
500 Ft. Coils w/Adhesive

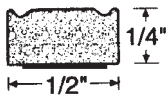

COLOR
Black

114-119 (black only)
500 Ft. Coils w/Adhesive



COLOR
Black

EUROPEAN DUST SEAL SYSTEMS

DR-1-*

Black (*BK), White (*WH), Brown (*BR)
PVC - 8 Ft. Lengths

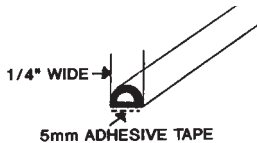

APPLICATION:

DR-1,
DR-6,

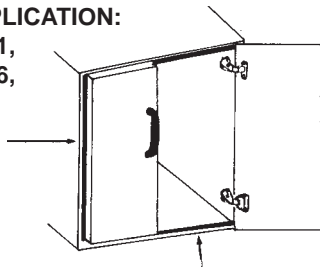

DR-2-*

Black (*BK), White (*WH), Brown (*BR),
Clear (*CL), Almond (*AL)
Dual Durometer/PVC - 8 Ft. Lengths

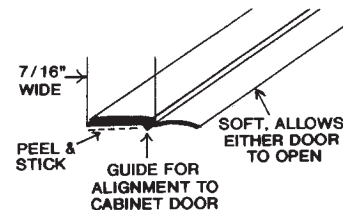

APPLICATION:

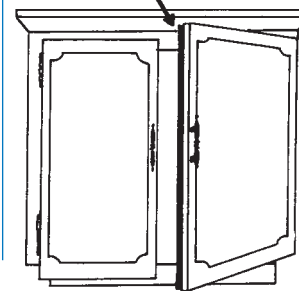

DR-6-*

White (*WH), Almond (*AL)
Polypropylene W/Santoprene
1000 Ft. Coils

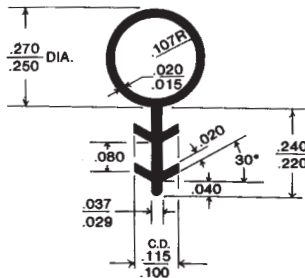

ULTRA PILE DUST SEAL / WEATHERSEAL w/ADHESIVE

**SELF SUPPORTING PILE IS ALWAYS ON CENTER
AND HAS THE INTEGRITY AND CONSISTENCY
TO ENSURE A TIGHT SEAL.**

MANY APPLICATIONS:

- Windows
- Doors
- Showcases



**50'
Minimum
Coil**

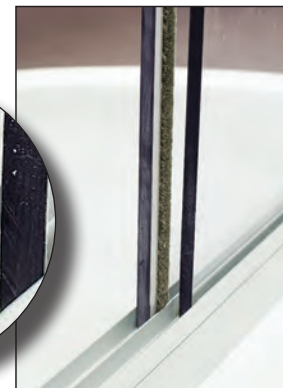
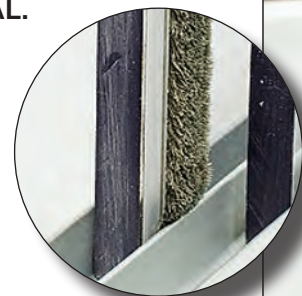

PART#	DESCRIPTION	COLOR
DS-150-GY	.270 W x .150 H	Gray
DS-200-GY	.270 W x .200 H	Gray

GLASS / PANEL RETAINING BUTTONS

FLUSH

R21-10

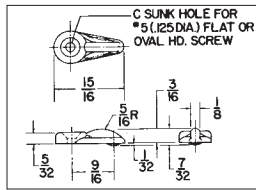

- Retainers are **P.E. plastic**. Clear retainers are **Lexan plastic**.
- Screws sold separately.

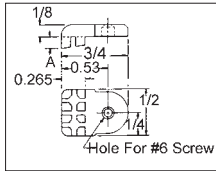

Brown only



R21-180

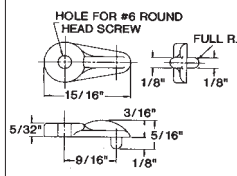

R21-183

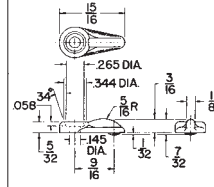

PART #	COLOR	USE SCREW
R21-10BE	Beige	A
R21-10BK	Black	A
R21-10CL	Clear	A
R21-180CL	Clear	B
R21-183BE	Beige	C

PART #	"A"	USE SCREW
R21-290	.125	B
R21-292	.250	B

R21 Series Screws

SCREW PART #	HEAD/FINISH	BULK CTN. QTY.
A SCR-5625FHZ	#5 x 5/8" Flat Head Zinc	(20M)
B SCR-6625PHZ	#6 x 5/8" Pan Head Zinc	(15M)
C SCR-6625FHZ	#6 x 5/8" Flat Head Zinc	(15M)

RECESSED

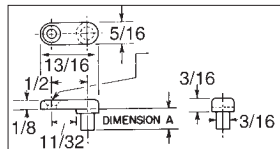

- Retainers are **P.E. plastic**. Clear retainers are **Lexan plastic**.
- They are for semi-permanent installations.
- Screws sold separately.

PART #	COLOR	DIM. "A"	USE SCREW
R21-281DB	Dk. Brown	5/16"	C
R21-281CL	Clear	5/16"	C
R21-313CL	Clear	1/8"	C

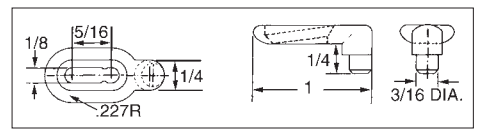

- To fasten: Twist button from side of frame and push back towards screw into locking position.
- To release: Twist and lift button over frame.
- Screws sold separately.

PART #	COLOR	USE SCREW
R21-175BE	Beige	A

GRILLE



- Screw adjustable, secure holding & quick removal of metal grilles.
- Reversible to accommodate varied glass thicknesses and door mortises.
- 7/8" vinyl tipped screw tightens and adjusts without harming glass.

BRONZE FINISH ON STEEL Overall Size: 3/8" wide x 1-3/16" long screws included.

PART #
SH-302



NO-ROUTE GLASS / PANEL RETAINING CLIPS



- Designed to attach glass or decorative panels to doors without routing.
- Can be screwed or stapled into place.
- Straight and corner pieces available.
- Available for 1/8" or 3/16" thick panels.

PART #	COLOR	MTL THICKNESS	TYPE
R21-1806BR	Brown	1/8"	Straight
R21-1806CL	Clear	1/8"	Straight
R21-1807BR	Brown	3/16"	Straight
R21-1807CL	Clear	3/16"	Straight
R21-1804BR	Brown	1/8"	Corner
R21-1804CL	Clear	1/8"	Corner
R21-1805BR	Brown	3/16"	Corner
R21-1805CL	Clear	3/16"	Corner

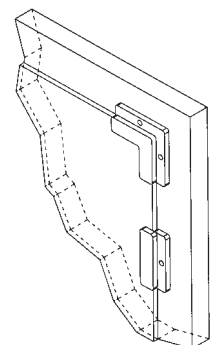

ADJUSTABLE PANEL/GLASS RETAINER



SOLD IN SETS
PART #
6500-*

Lengths: 12 Ft.
Material: RPVC
Accommodates all panels at 1/16", 1/8" & 1/4"
Colors Available
*LB - Light Beige *FW - Frost White *PLT - Platinum
unless otherwise noted

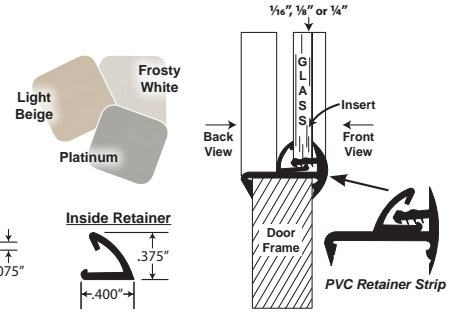

Insert May Be:

- Glass • Markerboard • Tackboard
- Expanded Metal Grilles
- Woven Wire Grilles
- Decorative MDF Screening Panel

PANEL RETAINER

Lengths: 500 Ft. Coils
Material: Vinyl
Colors Available

*WH - White *BK - Black *BR - Brown
unless otherwise noted

STAPLE TYPE

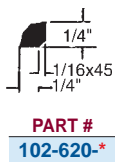
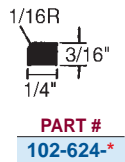
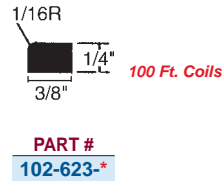
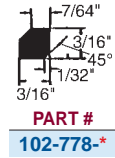
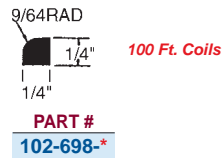
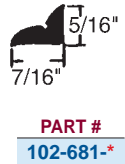
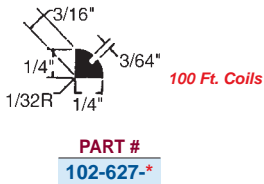
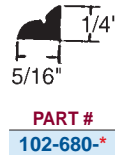
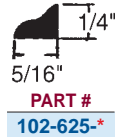
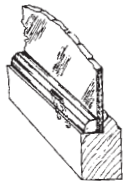

Lengths: 500 Ft. Coils
Material: Vinyl • Use S4 or S10 Slotter
Colors Available

*WH - White *BK - Black *BR - Brown *CL - Clear
unless otherwise noted

GROOVE TYPE

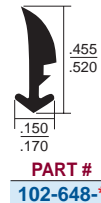
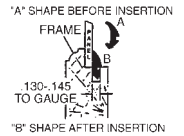

100 Ft. Coils
Also Available
In Fruitwood

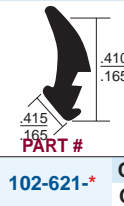

Also Available
In Fruitwood
& Clear

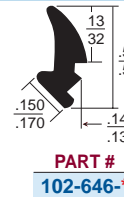

100 Ft. Coils

MIRROR CLIPS

Designed to attach mirrors, glass, decorative panels, etc. to any flat surface

Clear Diamond Back
• Made of crystal styrene
• Fits 1/4" glass thickness

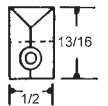

Use a #6 Pan or Flat head screw (Sold separately)

PART #
R45-283CL

Clear
• Made of crystal styrene, ribbed
• Fits 1/4" glass thickness

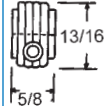

Use a #5 Flat head screw (Sold separately)

PART #
R45-293CL

Clear
• Made of crystal styrene
• Fits 1/8" glass thickness

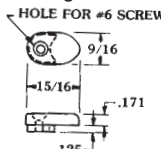

Use a #6 Pan or Flat head screw (Sold separately)

PART #
R45-433CL

FLAT HEAD ZINC SCREWS

PART #
SCR-5625FHZ
SCR-6625FHZ

PAN HEAD ZINC SCREWS

PART #
SCR-6625PHZ

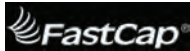

STANDARD

9/16" = 20 Sheets with 52 caps ea.
1040 per box

11/16" = 20 Sheets with 36 caps ea.
720 caps per box

PART#	SIZE
PVC Solid Colors	
FCSP916-	9/16"
FCSP1116-	11/16"
PVC Wood Colors	
FCWP916-	9/16"
FCWP1116-	11/16"
PVC Metallic	
FCME916-	9/16"
FCME1116-	11/16"
Unfinished (Real Wood)	
FCSW916-	9/16"
FCSW1116-	11/16"
Prefinished (Real Wood)	
FCPW916-	9/16"
FCPW1116-	11/16"

MINI BOX

9/16" = 5 Sheets with 52 caps ea.
260 per box

11/16" = 5 Sheets with 36 caps ea.
180 caps per box

PART#	SIZE
PVC Solid Colors	
FCMB916-	9/16"
FCMB1116-	11/16"
PVC Wood Colors	
FCMB916-	9/16"
FCMB1116-	11/16"
PVC Metallic	
FCMB916-	9/16"
FCMB1116-	11/16"
Unfinished (Real Wood)	
FCMB916-	9/16"
FCMB1116-	11/16"
Prefinished (Real Wood)	
FCMB916-	9/16"
FCMB1116-	11/16"

PRODUCT FEATURES:

- 9/16" (14mm) and 11/16" (18mm) Diameter
- Available in solid color PVC, PVC wood grain, PVC metallic, Unfinished solid wood and Finished solid wood
- Unlike other caps, these do not depend on the screw for proper installation
- Does not require any additional gluing or caulking

11/16"

(actual sizes)

9/16"

PVC (Solids, Woodgrains and Metallics)

White (WH)	Rosewood Oak (SD)	Presidential Walnut (PW)	Select Cherry (SC)
Antique White (AW)	Medium Oak (MD)	Imperial Walnut (IW)	Medium Cherry (MC)
Almond (AL)	Light Oak (LO)	Mahogany on Walnut (MW)	Bourbon cherry (BC)
Black (BK)	Hardrock Maple (HM)	Knotty Pine (KP)	Golden Cherry (GC)
Fog Gray (DG)	Manitoba Maple (MM)	Beech (BE)	Dark Cherry (DC)
Folkstone Gray (LG)	White washed Maple (WM)	Finished MDF (MDF)	Heritage Cherry (HT)
Natural Oak (NO)	Light Maple (LM)	Brushed Brass (BR)	Autumn Cherry (AC)
Golden Oak (GO)	Clear Maple (CM)	Polished Brass (PBR)	Fuji Cherry (FC)
Renaissance Oak (RN)	American Maple (AM)	Brushed Chrome (BCHR)	Red Mahogany (RM)
Pickled Oak (PO)	Natural Cherry (NC)	Polished Chrome (PCHR)	Dark Red Mahogany (RM)

Unfinished (Real Wood)

Red Oak (RO)	Cherry (CH)	Sapele (SP)	Vg Fir (VF)	Walnut (WA)
White Oak (WO)	Mahogany (MG)	Pecan (PE)	Anigre (AN)	White Birch (WB)
Maple (MP)	Pine (PN)	Teak (TK)	Ash (AS)	Natural Birch (NB)
			Hickory (HC)	Alder (AR)

Pre-finished (Real Wood)

Ash (FAS)	Teak (FTK)	Red Oak (FRO)	Cherry (FCH)	Birch (FB)
Sapele (FSP)	Alder (FAR)	White Oak (FWO)	Mahogany (FMA)	Walnut (FWA)
		Maple (FMP)	Anigre (FAN)	Yellow Pine (FYP)

FLUSH MOUNT DRILL BIT SYSTEM



- Carbide tipped
- Allows user to drill a pilot hole and countersink
- The drill bits custom stop insures that the surface cannot be marred



PART #	DESCRIPTION
FCDB-0916-CB	9/16" Drill bit

POP-ON SCREW COVERS & BASES

MATERIAL: POLYPROPYLENE

Pop-On Screw Covers & Bases may be used with flat head nails, countersunk wood screws, self-tapping screws rivets, drive screws, machine screws, washer faced screws and other types of fasteners. They may also be used with metric screws in M4, M4.5 and M6 screw sizes.

POP-ON SCREW COVERS

10 NEW COLORS



NEW: Green, Blue, Orange, Purple, Dark Blue, Light Pink, Forest Green, Red, Turquoise & Yellow.
Stock Colors & Metallics Available: Black, White, Brown, Light Gray, Beige, Brite Brass, Brite Chrome, Satin Chrome, Brite Copper & Satin Copper.

- **New colors** are in stock for SC2-250.
- Polypropylene caps are UV stabilized for outdoor use (**does not** include metallics).

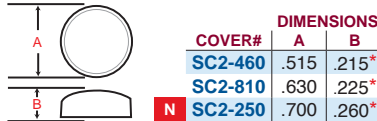

WORKS WITH COVER	BASE #	A	B	C	D	SCREW SIZE
SC2-460	SC2-B04P	.115	.415	.120	.275	#4 PAN
	SC2-B069	.115	.415	.151	.275	#6 PAN
	SC2-B46F	.115	.415	.151	-	#4/#6 COUNTERSUNK
SC2-810	SC2-B8P	.125	.505	.169	.365	#8 PAN
	SC2-B10P	.125	.505	.195	.365	#10 PAN
	SC2-B810F	.125	.505	.195	-	#8/#10 COUNTERSUNK
SC2-250	SC2-B250P	.125	.620	.245	.490	1/4-20 PAN
	SC2-B250F	.130	.620	.245	-	1/4-20 COUNTERSUNK

All Bases are a Natural Nylon Color

POP-ON SCREW BASES

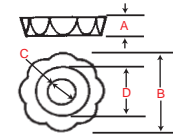

* ALLOW APPROX. .020" ADDITIONAL FOR ASSEMBLED HEIGHT.

SCREW COVER CAPS

Standard Screw Cover Caps Only .50 in Diameter

For PHILLIPS or POSI-DRIVE

Petite Screw Cover Caps Only .40 in Diameter

PART #	COLOR
SC-1LBR	Lt. Brown
SC-1DBR	Dk. Brown
SC-1WH	White
SC-1BK	Black
SC-1AL	Almond
SC-1DG	Dove Gray



PART #	COLOR
SC-4WH	White
SC-4BK	Black
SC-4BR	Brown
SC-4BE	Beige
SC-4LG	Light Gray

HINGED SCREW COVERS

MATERIAL: POLYPROPYLENE



PART #	COLOR	SCREW SIZE	A	B
SC3-460BK	Black	#4/#6 PAN	29/64"	3/16"
SC3-460WH	White	#4/#6 PAN	29/64"	3/16"
SC3-460BE	Beige	#4/#6 PAN	29/64"	3/16"
SC3-810BK	Black	#8/#10 PAN	35/64"	13/64"
SC3-810LG	Light Grey	#8/#10 PAN	35/64"	13/64"
SC3-810WH	White	#8/#10 PAN	35/64"	13/64"
SC3-810BE	Beige	#8/#10 PAN	35/64"	13/64"
SC3-250BK	Black	#1/4-20 PAN	45/64"	1/4"
SC3-250WH	White	#1/4-20 PAN	45/64"	1/4"
SC3-250BE	Beige	#1/4-20 PAN	45/64"	1/4"

SCREW PLUG BUTTON

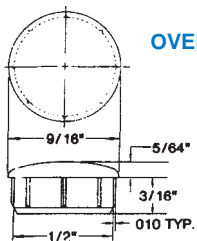

PART #	COLOR
R38-388BR	Brown

OVERHANGING HEAD
Polyethylene

LEXAN AND BUTYRATE STEM BUMPERS

USES: DOORS, BOTTOM OF FURNITURE, ETC.

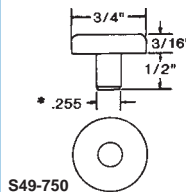

S49-750



* Pin Diameter
Tolerance = +/- .010

PART #	MATERIAL	COLOR
S49-750CL	Lexan	Clear
S49-750BK	Lexan	Black
S49-511CL	Butyrate	Clear

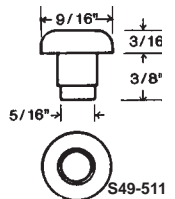

S49-511



PUSH KNOB LATCHES

Material: Zinc Alloy & ABS



LATCH BODY



- Knob and latch combined.
- Non-handed.
- Low profile.
- Use with door thickness 19/32" - 63/64".
- Provides 22 lbs. holding force.
- Ideal for use in RV's and boats. Anywhere space is limited for application.

SQUARE



Gold



Chrome



Satin Nickel

PART #	FINISH
DPL-SQ-G	Gold
DPL-SQ-CR	Chrome
DPL-SQ-SN	Satin Nickel

ROUND



Gold



Chrome

PART #	FINISH
DPL-RO-G	Gold
DPL-RO-CR	Chrome



OVAL



Gold



Chrome

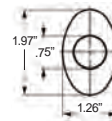

PART #	FINISH
DPL-OV-G	Gold
DPL-OV-CR	Chrome



NON-MAGNETIC LATCHES & CATCHES

MINI "LIGHT DUTY" NON-MAGNETIC TOUCH LATCH



MATERIAL: POLYPROPYLENE HOUSING & CATCH PLATE

- Push to latch and unlatch
- Screws included

PART #	COLOR	RETAINING FORCE
MC-20BL	Black	8.8 lbs.
MC-20WT	White	

MEDIUM "LIGHT DUTY" NON-MAGNETIC TOUCH LATCH

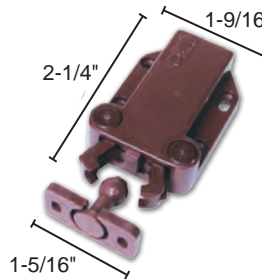

MATERIAL: ABS HOUSING & CATCH PLATE

- Push to latch and unlatch
- Screws included

PART #	COLOR	RETAINING FORCE
MC-37/BLK-1	Black	17.6 lbs.
MC-37/BRN-1	Brown	
MC-37/WHT-1	White	

ADJUSTABLE KNUCKLE CATCH

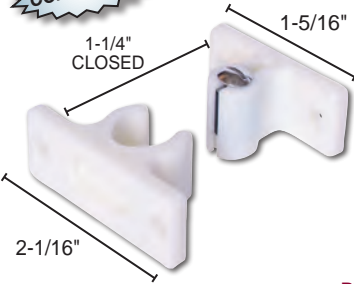

MATERIAL: POLYIMIDE HOUSING & CATCH PLATE

- Catch force is adjustable by turning screw
- Mounts with #10 Screws (not included)

PART #	COLOR	PUSH IN FORCE	PULLING FORCE
3-555-4/BLK	Black	29-57 lbs.	18-44 lbs.
1-555-2/WHT	White		

KNUCKLE CATCH

MATERIAL: WHITE POLYACETAL HOUSING WITH POLYIMIDE CATCH PLATE

- Grabs and holds door tightly

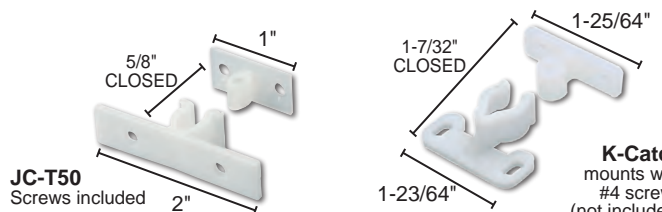

JC-T50
Screws included

K-Catch
mounts with #4 screws (not included)

PART #	COLOR	PUSH IN FORCE	PULLING FORCE
JC-T50	White	6.6 lbs.	8.3 lbs.
K-CATCH/WHT-T		12.5 lbs.	15.6 lbs.

SEALED MAGNETIC CATCHES



- Hermetically sealed for high corrosion resistance.
- No metal to metal contact, ideal for clean rooms
- Works with screw #8 (not included)

Polypropylene

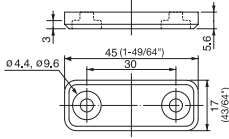

PART #	MAGNETIC FORCE	COLOR
MC-JM45WT	6.6 lbs.	White

Polyacetal



PART #	MAGNETIC FORCE	COLOR
MC-JM50/BL	6.6 lbs.	Black
MC-JM50/WT	6.6 lbs.	White

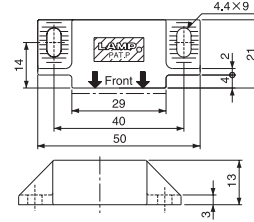

STRIKE PLATE (OPTIONAL)

Hermetically sealed strike eliminates metal particles when applied with MC-JM sealed magnetic catches

PART #
MC-JMP45

Other plates available please inquire

ULTRA THIN MAGNETIC CATCH



Steel with Nickel finish

- Ideal for tight spaces
- Max temperature 176°F
- Strike plate included
- Screws included

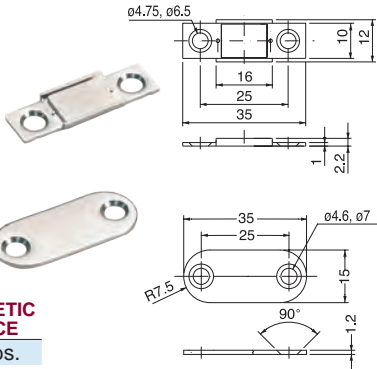

PART #	MAGNETIC FORCE
MC-YN001P	5.9 lbs.

MINI MAGNETIC CATCH



White Polybuthelene housing with Brite Zinc plated strike plate

- Available in strong or light magnetic force
- Strike plate included
- Screws Included

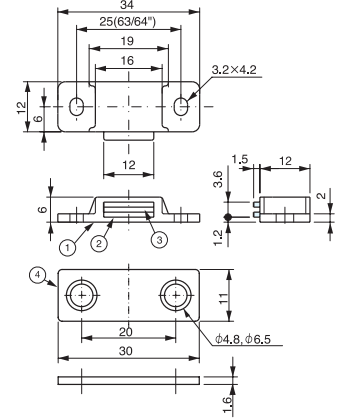

PART #	MAGNETIC FORCE
MC-YS001	6.6 lbs.
MC-YS002	2.6 lbs.

MAGNETIC TOUCH LATCHES

ABS housing with Nickel plated steel strike plate



- For single or double doors
- For overlay door allow a 4mm (5/32") gap between door & cabinet frame for pushing room
- Screws included

SINGLE

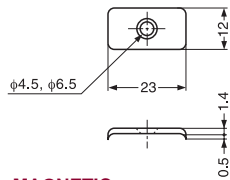

PART #	COLOR	MAGNETIC FORCE
ML-30S/BRN	Brown	2.6 lbs.
ML-30S/WHT	White	2.6 lbs.

DOUBLE

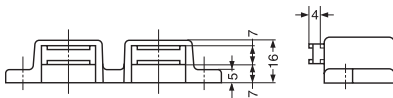

PART #	COLOR	MAGNETIC FORCE
ML-30W/BRN	Brown	2.6 lbs.
ML-30W/WHT	White	2.6 lbs.

RECTANGULAR MAGNETIC TOUCH LATCH



ABS housing with Zinc Chromate strike plate

- For overlay door allow a 3.5mm (9/64") gap between door and cabinet frame for pushing room.
- Screws included

SHORT

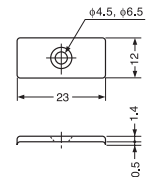

PART #	COLOR	TYPE	MAGNETIC FORCE
ML-80/BLK	Black	Short	3.5 lbs.
ML-80/BRN	Brown	Short	3.5 lbs.
ML-80/WHT	White	Short	3.5 lbs.

LONG

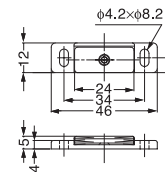

PART #	COLOR	TYPE	MAGNETIC FORCE
ML-120/BRN	Brown	Long	5.2 lbs.
ML-120/WHT	White	Long	5.2 lbs.

LATCHES & CATCHES

PLASTIC MAGNETIC CATCHES

WITH STRIKE PLATE • MATERIAL: ABS (Unless noted)

MAG-CATCH™ 1 LB. PULL FORCE

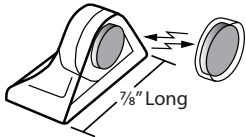

- Material: Acrylic DR101 (Clear), ABS (Black)
- Size: 7/8" L x 1/2" H x 3/8" W
- Adhesive mount

Adhesive mount solvent bonds to acrylic, polycarbonate, ABS and styrene. Eliminates unsightly screws or hardware.

PART #	COLOR
MC-SM-CL	Clear
MC-SM-BK	Black

6.6 LB. PULL FORCE

New



Uses Screw
SCR-6625FHZ
#6 x 5/8" Flat Head Zinc

- Size: 5/8" Dia. x 3/4" Long

PART #	COLOR
OI-132-BK	Black
OI-132-WH	White

MAGNETIC PUSH LATCH 8 LB. PULL FORCE



- Size: 1-3/16" L x 1-7/8" W x 3/4" H
- Screws included

PART #	COLOR
OI-346	Black

8.8 LB. PULL FORCE

New



Uses Screw
SCR-6625FHZ
#6 x 5/8" Flat Head Zinc

- Size: 2-1/4" L x 5/8" W x 1/2" H

PART #	COLOR
OI-121-BK	Black
OI-121-WH	White

DOUBLE MAGNETIC TOUCH LATCH 9 LB. PULL FORCE



- Size: 2-3/8" L x 1-7/8" W x 3/4" H
- Screws & Strike Plate included

PART #	COLOR
OI-347	Black

10 LB. PULL FORCE



- Size: 1-5/8" L x 7/8" W x 5/8" H
- Screws included

PART #	COLOR
OI-130-BR	Brown

10 LB. PULL FORCE



Uses Screw
SCR-6625FHZ
#6 x 5/8" Flat Head Zinc

- Size: 1-13/16" L x 5/8" W x 1/2" H

PART #	COLOR
OI-150-BK	Black
OI-150-BR	Brown
OI-150-WH	White

SUPER STRONG MAGNETIC CATCH 12 LB. PULL FORCE



Uses Screw
SCR-6625FHZ
#6 x 5/8" Flat Head Zinc

- Size: 1-7/8" L x 15/16" W x 15/16" H

PART #	COLOR
OI-418	Brown

26 LB. PULL FORCE

New



Uses Screw
SCR-6625FHZ
#6 x 5/8" Flat Head Zinc

- Size: 3-3/8" L x 11/16" W x 9/16" H

PART #	COLOR
OI-312-BR	Brown

ALUMINUM MAGNETIC CATCHES

WITH STRIKE PLATE

5 LB. PULL FORCE



- HEAVY DUTY
- Perfect for large cabinet doors
- Suitable for institutional or commercial cabinets
- Similar to EPCO #592

- Size: 2" L x 1-3/16" W x 13/16" H

PART #
OI-332-AL

Uses Screw
SCR-6625FHZ
#6 x 5/8" Flat Head Zinc

9 LB. PULL FORCE



- Size: 3-1/8" L x 1" W x 1/2" H

PART #
OI-632-AL

Uses Screw
SCR-6625FHZ
#6 x 5/8" Flat Head Zinc

14 LB. PULL FORCE



- Size: 3-1/8" L x 1" W x 3/4" H

PART #
OI-732-AL

Uses Screw
SCR-6625FHZ
#6 x 5/8" Flat Head Zinc

NON MAGNETIC CATCHES

DOOR CATCH with Strike Plate



- Material: Clear Acrylic
- Size: 5/8" L x 1-5/16" W
- Adhesive mount

PART #
DC-100-CL

DOUBLE BARREL FRICTION CATCH with Strike Plate



- Material: White H.D.P.E.
- Size: 1-3/4" L x 9/16" W x 11/16" H

Uses Screw SCR-6625PHZ
#6 x 5/8" Pan Head Zinc

PART #
274-167

DOUBLE ROLLER CATCH with Self-Locating Strike Plate

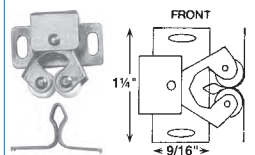

- Finishes: Antique Brass & Zinc
- Size: 1-3/4" L x 1-1/8" W x 1/2" H

Uses Screw
SCR-6625FHZ
#6 x 5/8" Flat Head Zinc

PART #	FINISH
OI-781AB	Antique Brass
OI-781Z	Zinc

DOUBLE BALL CABINET CATCH

Material: Brass Plated



PART #	SIZE
OI-881-BC	1-5/8"
OI-882-BC	2"
OI-883-BC	2-1/4"

FURNITURE/CABINET JOINERS & FASTENERS

MODESTY BLOCK

Material: Nylon

- Designed to attach modesty panels to desks
- No pre-drilling required, three screw application
- Place block against inside modesty panel & tighten screws; place panel against desk front & tighten third screw from block bottom into desk top

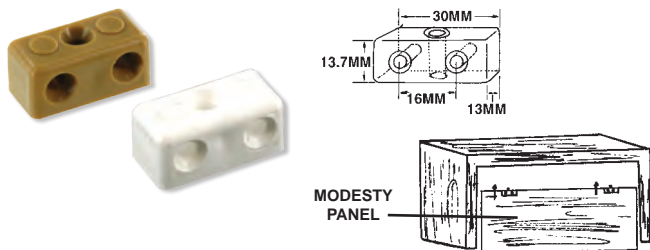

PART #	COLOR
6073-BR	Brown
6073-WH	White

Use #8 flathead screws (see below)

FURNITURE JOINER HARDWARE

Material: Steel, Zinc Finish

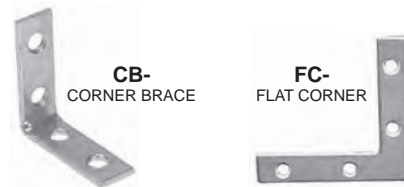

	PART #	DESCRIPTION
CORNER BRACES	CB-10	1" x 1" x 1/2" x 16 GA.
	CB-15	1-1/2" x 1-1/2" x 1/2" x 14 GA.
	CB-20	2" x 2" x 5/8" x 14 GA.
	CB-25	2-1/2" x 2-1/2" x 5/8" x 14 GA.
	CB-30	3" x 3" x 7/8" x 13 GA.
FLAT CORNER	CB-40	4" x 4" x 7/8" x 13 GA.
	FC-30	3" x 3" x 1/2" x 14 GA.

Use #8 flathead screws (see below)

KD BRACKETS

Material: Steel, Zinc Finish

- Countersunk holes

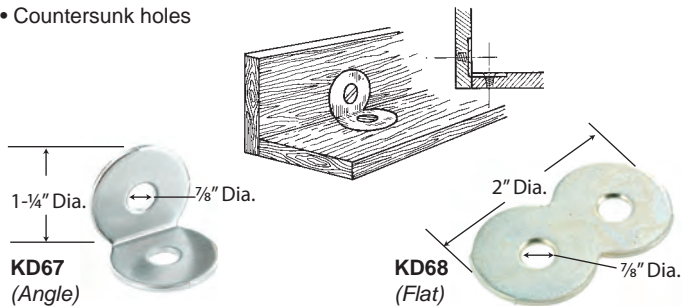

PART #	COLOR
KD67-ZINC	
KD68-ZINC	

Use #10 flathead screws (see below)

ANGLE BRACKETS

Material: H.D.P.E.

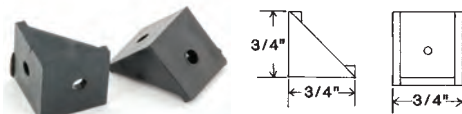

PART #	COLOR
R44-200BK	Black
R44-200WH	White

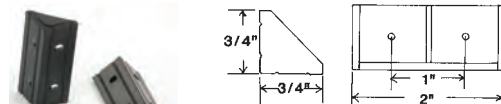

PART #	COLOR
R44-210BK	Black
R44-210WH	White

Use #6 panhead screws (see below)

FASTENERS

HF-1 HOOK-IN-FITTINGS

Material: Polycarbonate

- Hook-in fittings for mounting of panels, for built-in cabinets room dividers, etc

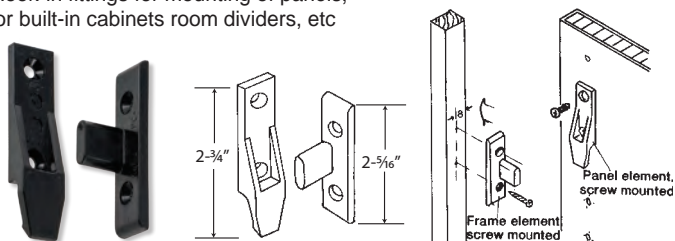

PART #	COLOR
HF-1	Black

Use #8 flathead screws (see below)

K-9 FASTENERS

Material: Nylon Body with Nickel Plated Steel Pin

- Easy to assemble & knockdown without tools or screws



PART #	COLOR
K-9WH	White
K-9BR	Brown

Use #6 flathead screws (see below)

FLAT HEAD ZINC SCREWS

PART #	SIZE
SCR-6625FHZ	#6 x 5/8"
SCR-8625FHZ	#8 x 5/8"
SCR-1625FHZ	#10 x 5/8"

PAN HEAD ZINC SCREWS

PART #	SIZE
SCR-6625PHZ	#6 x 5/8"

**20mm EXPANDO-6 HOUSING
NON-OUTRIGGER**

- **MATERIAL:** Nylon
- Available for 15mm/16mm & 18mm/19mm boards
- “Klix” locking system provides a strong, vibration proof connection
- Available in Almond, Black, White, Brown & Candlelight plastic
- Used in closet construction

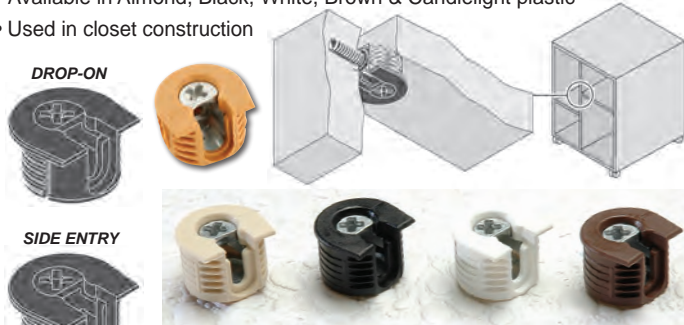

**20mm EXPANDO-6 HOUSING
OUTRIGGER**

- **MATERIAL:** Nylon
- Available for 15mm/16mm & 18mm/19mm boards
- “Klix” locking system provides a strong, vibration proof connection
- Available in Almond, Black, White & Brown plastic
- Used in closet construction

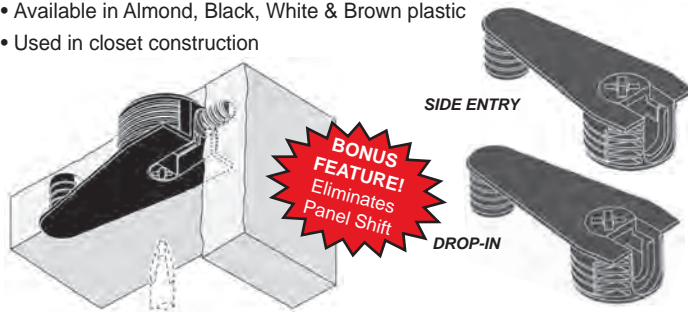

PART #	TYPE	BOARD SIZE	*COLOR (CHOOSE CODE)
OP6-6435-*	Non-Outrigger Side Entry	15mm/16mm	AL = Almond BK = Black WH = White BR = Brown CN = Candlelight
OP6-6437-*	Non-Outrigger Side Entry	18mm/19mm	
OP6-6431-*	Non-Outrigger Drop On	15mm/16mm	
OP6-6433-*	Non-Outrigger Drop On	18mm/19mm	
OP6-6443-*	Outrigger Side Entry	15mm/16mm	
OP6-6445-*	Outrigger Side Entry	18mm/19mm	
OP6-6439-*	Outrigger Drop On	15mm/16mm	
OP6-6441-*	Outrigger Drop On	18mm/19mm	

5mm DOWELS

- **MATERIAL:** Steel
- 5mm x 11mm dowel
- Klix locking system provides a strong, vibration proof connection
- Features an integral skirt which acts as a positive stop during insertion
- Zinc Plated



PART #	PIECES PER CARTON
OPHS-6406	5000

15mm CAM

- **MATERIAL:** Steel
- For 16mm (.64”) & 19mm (.76”) board thicknesses
- Linear cam profile results in smooth, easy cam rotation & dowel pull up
- “Klix” locking feature provides a strong, vibration proof joint

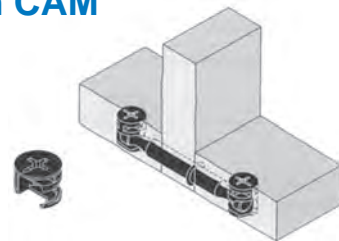

PART #	PANEL SIZE	FINISH	PIECES PER CARTON
OP5-5644B	16mm	Black	2000
OP5-5644Z	16mm	Zinc	2000
OP5-5656Z	19mm	Zinc	2000

FASTENER FOR FACE & EDGE BORING

- One turn lock system, thus reduces assembly time
- Pre-assembled for consumer convenience
- (1”) 25mm dia. housing x (1/2”) 12.5mm depth

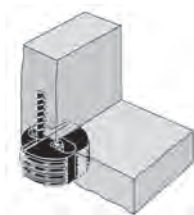

PART #	DESCRIPTION	MATERIAL	PIECES PER CARTON
OPHS-3118	White Housing	Nylon	2500
OP-3118BR	Brown Housing	Nylon	2500
OPHS-3150	White Decorative Cap	Nylon	1000
OPHS-3180	White Hilo Screw Dowel	Steel	2500
OPHS-3168	Euro Screw Dowel - Zinc	Steel	2500

WOODEN DOWEL PINS

- White Birch
- * Available Fluted or Spiral

(*Please Specify Fluted or Spiral When Ordering)

- Kiln Dried To 6-8% Moisture

*Which pin is better, Spiral or Fluted? ...*There is no real answer as to which pin offers better holding power. While some manufacturers dowel-inserting machinery may advise which groove suits its machinery better, both pins offer excellent dispersion of glue as well as excellent bonding qualities.

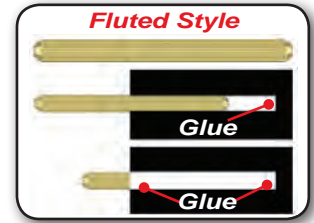
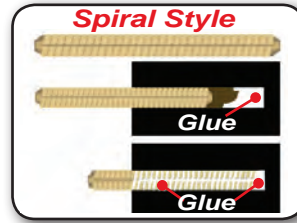

SIZE: 1/4" x 1" (*Fluted or Spiral)			
PART #	R25-2510C*	R25-2510M*	R25-2510B* (Bulk)
QUANTITY	100 Pcs./Bag	1,000 Pcs./Bag	25,000 Pcs. 100,000 Pcs.
SIZE: 1/4" x 1-1/2" (*Fluted or Spiral)			
PART #	R25-2515C*	R25-2515M*	R25-2515B* (Bulk)
QUANTITY	100 Pcs./Bag	1,000 Pcs./Bag	25,000 Pcs. 100,000 Pcs.
SIZE: 1/4" x 1-3/4" (*Fluted or Spiral)			
PART #	R25-2517C*	R25-2517M*	R25-2517B* (Bulk)
QUANTITY	100 Pcs./Bag	1,000 Pcs./Bag	25,000 Pcs. 100,000 Pcs.
SIZE: 1/4" x 2" (*Fluted or Spiral)			
PART #	R25-2520C*	R25-2520M*	R25-2520B* (Bulk)
QUANTITY	100 Pcs./Bag	1,000 Pcs./Bag	25,000 Pcs. 100,000 Pcs.
SIZE: 3/8" x 1" (*Fluted or Spiral)			
PART #	R25-3710C*	R25-3710M*	R25-3710B* (Bulk)
QUANTITY	100 Pcs./Bag	1,000 Pcs./Bag	25,000 Pcs. 100,000 Pcs.
SIZE: 3/8" x 1-1/4" (*Fluted or Spiral)			
PART #	R25-3712C*	R25-3712M*	R25-3712B* (Bulk)
QUANTITY	100 Pcs./Bag	1,000 Pcs./Bag	25,000 Pcs. 100,000 Pcs.
SIZE: 3/8" x 1-1/2" (*Fluted or Spiral)			
PART #	R25-3715C*	R25-3715M*	R25-3715B* (Bulk)
QUANTITY	100 Pcs./Bag	1,000 Pcs./Bag	25,000 Pcs. 100,000 Pcs.
SIZE: 3/8" x 1-3/4" (*Fluted or Spiral)			
PART #	R25-3717C*	R25-3717M*	R25-3717B* (Bulk)
QUANTITY	100 Pcs./Bag	1,000 Pcs./Bag	25,000 Pcs. 100,000 Pcs.
SIZE: 3/8" x 2" (*Fluted or Spiral)			
PART #	R25-3720C*	R25-3720M*	R25-3720B* (Bulk)
QUANTITY	100 Pcs./Bag	1,000 Pcs./Bag	25,000 Pcs. 100,000 Pcs.
SIZE: 3/8" x 2-1/2" (*Fluted or Spiral)			
PART #	R25-3725C*	R25-3725M*	R25-3725B* (Bulk)
QUANTITY	100 Pcs./Bag	1,000 Pcs./Bag	25,000 Pcs. 100,000 Pcs.
SIZE: 7/16" x 1-1/2" (*Fluted or Spiral)			
PART #	R25-4315C*	R25-4315M*	R25-4315B* (Bulk)
QUANTITY	100 Pcs./Bag	1,000 Pcs./Bag	25,000 Pcs. 100,000 Pcs.
SIZE: 7/16" x 1-3/4" (*Fluted or Spiral)			
PART #	R25-4317C*	R25-4317M*	R25-4317B* (Bulk)
QUANTITY	100 Pcs./Bag	1,000 Pcs./Bag	25,000 Pcs. 100,000 Pcs.

SIZE: 7/16" x 2" (*Fluted or Spiral)			
PART #	R25-4320C*	R25-4320M*	R25-4320B* (Bulk)
QUANTITY	100 Pcs./Bag	1,000 Pcs./Bag	25,000 Pcs. 100,000 Pcs.
SIZE: 7/16" x 2-1/2" (*Fluted or Spiral)			
PART #	R25-4325C*	R25-4325M*	R25-4325B* (Bulk)
QUANTITY	100 Pcs./Bag	1,000 Pcs./Bag	25,000 Pcs. 100,000 Pcs.
SIZE: 7/16" x 3" (*Fluted or Spiral)			
PART #	R25-4330C*	R25-4330M*	R25-4330B* (Bulk)
QUANTITY	100 Pcs./Bag	1,000 Pcs./Bag	25,000 Pcs. 100,000 Pcs.
SIZE: 1/2" x 2" (*Fluted or Spiral)			
PART #	R25-5020C*	R25-5020M*	R25-5020B* (Bulk)
QUANTITY	100 Pcs./Bag	1,000 Pcs./Bag	25,000 Pcs. 100,000 Pcs.
SIZE: 1/2" x 2-1/2" (*Fluted or Spiral)			
PART #	R25-5025C*	R25-5025M*	R25-5025B* (Bulk)
QUANTITY	100 Pcs./Bag	1,000 Pcs./Bag	25,000 Pcs. 100,000 Pcs.
SIZE: 1/2" x 3" (*Fluted or Spiral)			
PART #	R25-5030C*	R25-5030M*	R25-5030B* (Bulk)
QUANTITY	100 Pcs./Bag	1,000 Pcs./Bag	25,000 Pcs. 100,000 Pcs.

METRIC SIZES

SIZE: 6mm x 25mm (*Fluted or Spiral)			
PART #	R25-6250C*	R25-6250M*	R25-6250B* (Bulk)
QUANTITY	100 Pcs./Bag	1,000 Pcs./Bag	25,000 Pcs. 100,000 Pcs.
SIZE: 6mm x 30mm (*Fluted or Spiral)			
PART #	R25-6300C*	R25-6300M*	R25-6300B* (Bulk)
QUANTITY	100 Pcs./Bag	1,000 Pcs./Bag	25,000 Pcs. 100,000 Pcs.
SIZE: 8mm x 30mm (*Fluted or Spiral)			
PART #	R25-8300C*	R25-8300M*	R25-8300B* (Bulk)
QUANTITY	100 Pcs./Bag	1,000 Pcs./Bag	25,000 Pcs. 100,000 Pcs.
SIZE: 8mm x 32mm (*Fluted or Spiral)			
PART #	R25-8320C*	R25-8320M*	R25-8320B* (Bulk)
QUANTITY	100 Pcs./Bag	1,000 Pcs./Bag	25,000 Pcs. 100,000 Pcs.
SIZE: 8mm x 35mm (*Fluted or Spiral)			
PART #	R25-8350C*	R25-8350M*	R25-8350B* (Bulk)
QUANTITY	100 Pcs./Bag	1,000 Pcs./Bag	25,000 Pcs. 100,000 Pcs.

FURNITURE DOWELS

MODESTY BLOCK

Material: Polyethylene

- Moisture Resistant
- No glue necessary
- Self Locking

Advanced Polymer Tech
Moisture Resistant



**BEST BUY
GREAT VALUE**

PART #	SIZE	COLOR
R25-830	8mm x 30mm	Black

FURNITURE JOINER HARDWARE

Material: Nylon

For joints stronger than the wood or wood product itself

ELIMINATES GLUING & CLAMPING

- Reduces assembly time
- Insert manually or with most doweling machines
- Not affected by humidity
 - less likely to jam insertion equipment
- Forced fit - no glue necessary

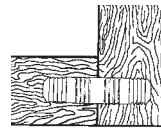

PREMIUM SERIES

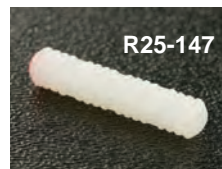

R25-147



R25-604



R25-860

PART #	DIAMETER x LENGTH	COLOR
R25-147	6mm x 1-1/8"	Natural
R25-604	8mm x 1-1/2"	Natural
R25-860	8mm x 1-1/2"	Natural

WINDOW SHUTTER PINS

STANDARD SHUTTER PIN

Material: Nylon

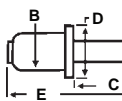

A = Pin Diameter: 0.14"
B = Head Diameter: .242"
C = Pin Length: .676"
D = Shoulder Diameter: .306"
E = Full Length: 1.076"

PART #	COLOR
SP-1	Natural

RETRACTABLE SHUTTER PIN

Material: Polyethylene

- Great for replacements & repairs

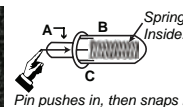

A = Pin Diameter: 0.14"
B = Head Diameter: .24"
C = Full Length: .875"

PART #	COLOR
SP-17	White

TENSION CONTROL SHUTTER PIN

Material: Nylon

- Cuts down on loose slats.

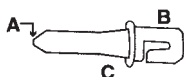

A = Pin Diameter: 0.14"
B = Head Diameter: .24"
C = Full Length: 1.08"
Spring Diameter: 0.255"

- For 2-1/2" louver, use every 3rd slat
- For 3-1/2" louver, use every 2nd slat
- For 4-1/2" louver, use every slat

PART #	COLOR
SP-19	Natural

FASTENERS

RATCHET ASSEMBLY POST & SCREW

- Polypropylene
- Simply press together these screws with serrated pins for fast and easy assembly
- Works with flat panels, punched papers, key cases, catalogs, etc.
- Not intended for applications requiring removable/reusable fasteners!
- Usable in corrosive environments
- Will not mark or mar most surfaces

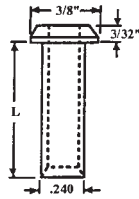

REACH & ROHS COMPLIANT

PART #	COLOR	LENGTH
SP-250BK	Black	1/4"
SP-250WH	White	1/4"
SP-375BK	Black	3/8"
SP-375WH	White	3/8"
SP-500BK	Black	1/2"
SP-500WH	White	1/2"
SP-750BK	Black	3/4"
SP-750WH	White	3/4"

NATURAL NYLON ARROW CLIPS

- Molded natural nylon fasteners offer an inexpensive fast method to hand assemble metal, wood and plastic composition or any other thin gauge materials
- Reusable
- Specially designed body compresses through a pre-punched hole and springs back to shape, locking the assembled parts securely
- Provides a vibration, abrasion and corrosion resistant connection
- Electrically insulating



REACH & ROHS COMPLIANT

PART #	HOLE SIZE	PANEL THICKNESS RANGE	HEAD DIA. 'D'	HEAD HEIGHT 'A'	LENGTH 'B'	CLIP DIA. 'C'
AC-001	.182/.192	.062/.125	.360	.060	.400	.225
AC-003	.151/.161	.062/.125	.280	.040	.390	.196
AC-006	.182/.192	.310/.330	.370	.060	.540	0.225
AC-009	.250/.260	.125/.187	.484	.060	.575	.290
AC-015	.118/.122	.062/.125	.280	.060	.390	.150
AC-016	.250/.260	.360/.380	.610	.065	.810	0.286

OTHER SIZES AVAILABLE - PLEASE INQUIRE

PLASTIC FASTENERS

REACH & ROHS COMPLIANT

CANOE FASTENERS

CELCON
Black & White

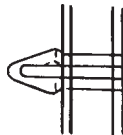

PART #	COLOR	HOLE SIZE	SHAFT	HEAD DIA.	WORK THICKNESS
PF6-20BK	Black	3/16"	5/8"	13/32"	.228
PF6-20WH	White	3/16"	5/8"	13/32"	.228
PF6-31BK	Black	3/16"	5/8"	27/64"	.325
PF6-31WH	White	3/16"	5/8"	27/64"	.325

ROW BOAT FASTENERS

HDPE
Black & White

- Fits hole size 1/4"
- Fits work thickness 1/4"



PART #	COLOR
CF8-20BK	Black
CF8-20WH	White

TREE FASTENERS

NYLON

Black, White & Gray

Used for one-time applications & is purposely difficult to remove



PART #	COLOR	HOLE SIZE	SHAFT	HEAD DIA.	WORK THICKNESS
PF8-16BK	Black	1/4"	1/2"	11/16"	.180-.220
PF8-16WH	White	1/4"	1/2"	11/16"	.180-.220
PF8-20BK	Black	1/4"	5/8"	11/16"	.180-.380
PF8-20WH	White	1/4"	5/8"	11/16"	.180-.380
PF8-20GY	Gray	1/4"	5/8"	11/16"	.180-.380
PF8-24BK	Black	1/4"	3/4"	11/16"	.180-.570
PF8-28BK	Black	1/4"	7/8"	11/16"	.180-.700
PF8-32BK	Black	1/4"	1"	11/16"	.180-.820

FLAT & PAN HEAD PARTICLE BOARD SCREWS



Flat Head Screws

Zinc or Black
Phillips Drive,
Coarse Thread

PART #	FINISH	SIZE	BULK CTN QTY.
SCR-5500FHZ	Zinc	#5 x 1/2"	25,000
SCR-5625FHZ	Zinc	#5 x 5/8"	20,000
SCR-6500FHZ	Zinc	#6 x 1/2"	20,000
SCR-6625FHZ	Zinc	#6 x 5/8"	15,000
SCR-8625FHZ	Zinc	#8 x 5/8"	12,000
SCR-8750FHZ	Zinc	#8 x 3/4"	10,000
SCR-1625FHZ	Zinc	#10 x 5/8"	10,000
SCR-1750FHZ	Zinc	#10 x 3/4"	8,000
SCR-5500FHB	Black	#5 x 1/2"	25,000
SCR-5625FHB	Black	#5 x 5/8"	20,000
SCR-6500FHB	Black	#6 x 1/2"	20,000
SCR-6625FHB	Black	#6 x 5/8"	15,000
SCR-8625FHB	Black	#8 x 5/8"	12,000
SCR-8750FHB	Black	#8 x 3/4"	10,000
SCR-1625FHB	Black	#10 x 5/8"	10,000
SCR-1750FHB	Black	#10 x 3/4"	8,000

Pan Head Screws

Zinc or Black
Phillips Drive,
Coarse Thread

PART #	FINISH	SIZE	BULK CTN QTY.
SCR-6500PHZ	Zinc	#6 x 1/2"	20,000
SCR-6625PHZ	Zinc	#6 x 5/8"	15,000
SCR-6100PHZ	Zinc	#6 x 1"	10,000
SCR-8500PHZ	Zinc	#8 x 1/2"	15,000
SCR-8625PHZ	Zinc	#8 x 5/8"	12,000
SCR-8750PHZ	Zinc	#8 x 3/4"	10,000
SCR-8100PHZ	Zinc	#8 x 1"	8,000
SCR-1625PHZ	Zinc	#10 x 5/8"	10,000
SCR-1750PHZ	Zinc	#10 x 3/4"	8,000
SCR-1875PHZ	Zinc	#10 x 7/8"	7,000
SCR-1100PHZ	Zinc	#10 x 1"	6,000
SCR-6500PHB	Black	#6 x 1/2"	20,000
SCR-6625PHB	Black	#6 x 5/8"	15,000
SCR-6100PHB	Black	#6 x 1"	10,000
SCR-8500PHB	Black	#8 x 1/2"	15,000
SCR-8625PHB	Black	#8 x 5/8"	12,000
SCR-8750PHB	Black	#8 x 3/4"	10,000
SCR-8100PHB	Black	#8 x 1"	8,000
SCR-1625PHB	Black	#10 x 5/8"	10,000
SCR-1750PHB	Black	#10 x 3/4"	8,000
SCR-1875PHB	Black	#10 x 7/8"	7,000
SCR-1100PHB	Black	#10 x 1"	6,000

FINISHING WASHERS

COLOR: NATURAL NYLON

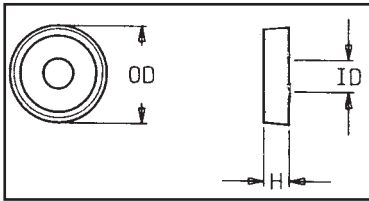

PART #	SCREW SIZE	ID		OD		H	
		IN.	MM	IN.	MM	IN.	MM
CFW-6	6	.143	3.63	.437	11.10	.100	2.54
CFW-8	8	.171	4.34	.515	13.08	.115	2.92
CFW-10	10	.191	4.85	.580	14.73	.152	3.86

FURNITURE ASSEMBLY FASTENERS

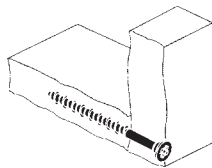

POSI SCREWS

Titus

• 250 PIECES PER CARTON •

PART #	DESCRIPTION
OP-0071	8x33mm HI-LO Funnel Head
OP-0077	8x45mm HI-LO Funnel Head
OP-6077	8x50mm HI-LO Funnel Head
OP-6080	11x50mm HI-LO Funnel Head

ANCHORING SOLUTIONS BY TOGGLER®

MADE IN THE U.S.A.

Fast, easy, secure anchoring in ALL building materials — drywall, gypsumboard, brick, concrete, block, stone, plaster ...
 • No special tools needed • Lowest in-place anchoring cost • Stronger than any anchor of comparable screw size

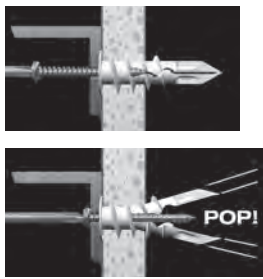

TOGGLER® BRAND SnapSкру® Self-Drilling Drywall Anchors

- Holds over 80% more than other self-drilling drywall anchors
- Works with #6, #8, and #10 screws (#8 preferred)
- Locks on wall — resists shock & vibration
- Positive "stop" resists overturning • Installs with screwdriver or screw gun
- Can remove screw & item, leaving anchor in wall for reuse
- Activates with audible "pop", indicating correct installation

PART #	DESCRIPTION	GRIP	SCREW	SCREWS	BOX
TA-0012	SP™ drywall anchors	3/8"-5/8"	#6-#10	50	50

****#8 x 1 1/2" COMBO HEAD SCREWS INCLUDED IN TA-0012 BOXES
 — EACH ITEM IS SOLD IN FULL BOXES ONLY — NO BROKEN BOXES****

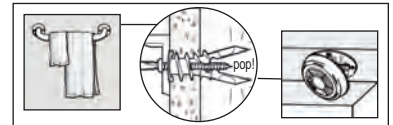

Securely hang alarms, mirrors, bathroom accessories, picture frames, drapery, lighting fixtures, smoke detectors, thermostats, electric boxes, etc.



TOGGLER® BRAND SNAPTOGGLE® Toggle Bolts

Strongest holding in smallest hole • Vibration-proof—anchor centers bolt
 Can be used with a screw gun—won't spin in the hole • Fast & easy
 Reusable in same hole—metal channel stays in place when bolt removed

BA 3/16"-24 • BB 1/4"-20 = Drill diameter: 1/2" (13mm)
 Grip Range: 3/8"—3 5/8" (10mm—92mm)
 Minimum clearance behind wall: 1 7/8" (48mm)

BC 3/8"-16 • BD 1/2"-13 = Drill diameter: 3/4" (19mm)
 Grip Range: 3/8"—2 1/2" (10mm—64mm)
 Minimum clearance behind wall: 1 7/8" (48mm)



Superior holding for heavy-duty anchoring in hollow walls and ceilings
 Use in drywall, concrete block, plaster, tile over drywall, or tile over greenboard

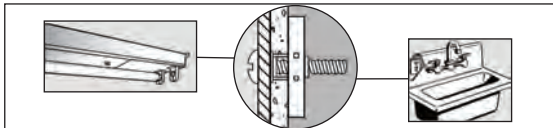

PART #	DESCRIPTION	THREAD	DRILL	GRIP	BOX
TA-1013	BA™ SNAPTOGGLE toggle bolt	3/16"-24	1/2"	3/8" - 3-5/8"	100
TA-1014	BB™ SNAPTOGGLE toggle bolt	1/4"-20	1/2"	3/8" - 3-5/8"	100
TA-1015	BC™ TOGGLER toggle bolt	3/8"-16	3/4"	3/8" - 2-1/2"	25
TA-1016	BD™ TOGGLER toggle bolt	1/2"-13	3/4"	3/8" - 2-1/2"	25

*****THREADED BOLTS ARE NOT INCLUDED—
 EACH ITEM IS SOLD IN FULL BOXES ONLY — NO BROKEN BOXES*****

TOGGLER® Hollow-Wall Anchors

Largest range of screw sizes per anchor • Vibration- & shock-proof
 5/16" drill only • Can be used with a screw gun • Don't spin in the hole

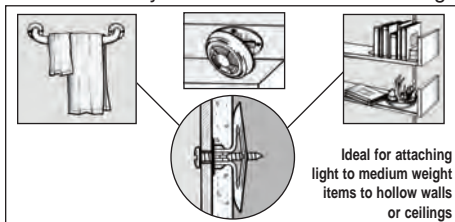

Ideal for attaching light to medium weight items to hollow walls or ceilings

TA® Hollow doors & thin panels
 TB® Walls & Ceilings

PART #	DESCRIPTION	GRIP	SCREW	DRILL	BOX
TA-1009	TA® hollow door anchors	1/8"-1/4"	#8-#12	5/16"	100
TA-1010	TB® drywall anchors	3/8"-1/2"	#6-#14	5/16"	100
TA-1011	TC® drywall anchors	5/8"-3/4"	#6-#14	5/16"	100
TA-1021	TD™ drywall anchors	1"	#6-#14	5/16"	50
TA-1029	T35™ drywall anchors	1 3/8"	#6-#14	5/16"	50

*****EACH ITEM COMES WITH 3 SETTING KEYS PER BOX —
 EACH ITEM IS SOLD IN FULL BOXES ONLY — NO BROKEN BOXES*****

TOGGLER brand anchors are patented under one or more U.S. Patent Nos. 4,673,150; 4,878,790; 4,993,901; 5,028,186; 5,161,296; 5,983,385; 6,161,999; and foreign counterparts thereof and of 4,650,386 and 4,752,170. Other patents pending. TOGGLER and typeface, TA, TB, TC, TH, SnapSкру, SNAPTOGGLE, ALLIGATOR, and ALLIGATOR symbol are worldwide registered trademarks of Mechanical Plastics Corp. AS, AF5, AF6, AF8, AF8, BA, BB, BC, BD, SP, TD, T35, and TBS1 are worldwide trademarks of MPC.

TOGGLER® BRAND ALLIGATOR® Solid-Wall Anchors

Outhold metal anchors twice the screw size • Vibration- and shock-proof
 Corrosion-proof when used with a stainless steel screw • Set instantly
 Can be used with a screw gun • Don't spin or countersink in the hole



A series = Flushmount
 For through-the-fixture anchoring

AF series = Flanged
 Use where there may be a hollow

The most modern, versatile, and effective anchor for light to heavy-duty anchoring in solid walls, which also works if you hit a hidden cavity

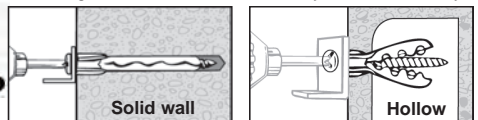

Anchor extrudes down screw—up to 2x its original length—for high holding values. Anti-rotation fins prevent spinning.
 Anchor also works if it hits a hidden cavity or hollow in or behind the wall. Screw thread locks into anchor's teeth.

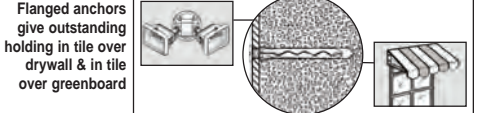

Flanged anchors give outstanding holding in tile over drywall & in tile over greenboard

PART #	DESCRIPTION	SCREW	DRILL	BOX
TA-3103	AF™ 3/16" dia. flanged anchors	#4-#10	3/16"	200
TA-3101	AF6™ 1/4" dia. flanged anchors	#6-#14	1/4"	100
TA-3102	AF8™ 5/16" dia. flanged anchors	#6-5/16"	5/16"	100
TA-3106	A5™ 3/16" dia. flushmount anchors	#4-#10	3/16"	200
TA-3104	A6™ 1/4" dia. flushmount anchors	#6-#14	1/4"	100
TA-3105	A8™ 5/16" dia. flushmount anchors	#6-5/16"	5/16"	100

*****EACH ITEM IS SOLD IN FULL BOXES ONLY — NO BROKEN BOXES*****

TOGGLER® Specialty Anchors

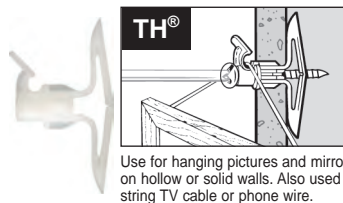

Use for hanging pictures and mirrors on hollow or solid walls. Also used to string TV cable or phone wire.

The same vibration- and shock-proof holding of the TOGGLER Hollow-Wall Anchors plus specially designed heads for specialized applications

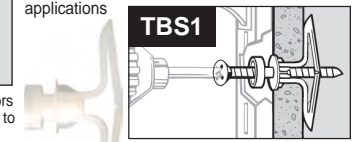

One-piece anchor with spacer for installing C-channel wall standards in perfect alignment and preventing jacking of the anchor.

PART #	DESCRIPTION	GRIP	SCREW	DRILL	BOX
TA-1012	TH® picture hook anchors	3/8"-1/2"	#6-#14	5/16"	100
TA-1023	TBS1™ shelving anchors	3/8"-1/2"	#6-#14	5/16"	50
TA-1022	TBS2™ pegboard anchors	3/8"-1/2"	#6-#14	5/16"	50
TA-1024	TBW™ wire shelf anchors	3/8"-1/2"	#6-#14	5/16"	50

*****EACH ITEM COMES WITH 3 SETTING KEYS PER BOX —
 EACH ITEM IS SOLD IN FULL BOXES ONLY — NO BROKEN BOXES*****

ECONOMY WALL ANCHORS

POLYPROPYLENE

Used for through the fixture mounting
 1/4" Diameter Flush Mount Anchor

PART #	SCREW	DRILL
STD-ANCHOR	#6-#14	1/4"

SOLD IN BOXES OF 100 PCS. - NO BROKEN BOXES

TABLE ESSENTIALS

TABLE ALIGNERS

Material: H.D.P.E.



PART #	COLOR
CN-01	Brown

#8 Flathead Screws

PART #	FINISH	SIZE
SCR-8625FHZ	Zinc	#8 x 5/8"

Material: Steel



PART #
H-3

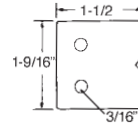

Application On Table
Underside:

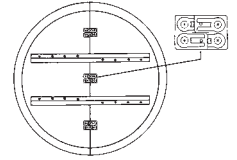

#10 Panhead Screws

PART #	FINISH	SIZE
SCR-1625PHZ	Zinc	#10 x 5/8"

TABLE PINS

Material: H.D.P.E.

- Self-lubricating for easy, smooth action; will not swell, shrink, check or rust
- No glue required
- Finishing materials will not adhere to the pin; will not mar fine table surfaces
- Table pins are also used for top & bottom glides for sliding doors

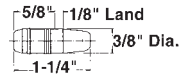

PART #	COLOR
R25-81BE	Beige

DROP LEAF TABLE WEDGE

Material: H.D.P.E.

- Use where sliding surfaces must be protected against friction & wear
- Will not crack or split
- Staple under table top

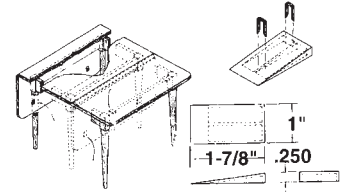
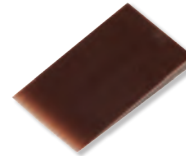

PART #	COLOR
R50-108DB	Dk. Brown

FLIP BOLT CONNECTOR

Material: Steel

Nirvana... the tool-less countertop connector is here. The Flip Bolt is fast and easy, requires **no tools** and is great for most countertop connections.

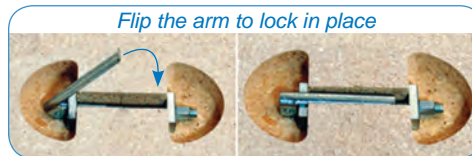
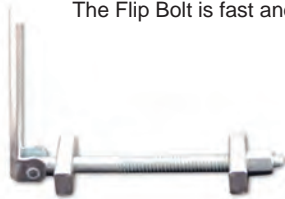

PART #	SIZE
FC-FB	4-1/2"

FREE
Samples

Reasonable sample quantities are available at no charge for many of the featured products within this catalog to test their suitability for your intended use or application. Please discuss with our sales representatives.

Most samples are sent mail or U.P.S. ground. Next day delivery is available, provided the customer pays the freight.

SWIVELS

7" FLAT OR 3-D

THIS IS OUR MOST POPULAR AND VARIED LINE OF SWIVELS. 7" SQUARE PLATES HAVE SLOTS ON 5-1/4" CENTERS. 12 GAUGE STEEL. PITCH AVAILABLE IN FLAT, 3°.

NOTE: FLAT SWIVELS ARE FOR CHAIRS WITHOUT BACKS, 3-D SWIVELS ARE FOR CHAIRS WITH BACKS.

Top & Bottom Plates,
5-1/4" Slotted Centers
7 Square Plate
12 Gauge Steel
Pieces Per Carton: 16



Standard Swivel Used On Entire Trendler Pedestal Base Line.
May Be Used In Conjunction With 3-1/4" Weld Plates.
Four 1/4"-20 Threaded Holes On 2-1/2" Centers.
Pieces Per Carton: 25
Weight Each: 2.50 Lbs.



REVOLVING TURNTABLES

STEEL LAZY SUSAN

- Only 5/16" Thick (Can be recessed into surfaces for 1/8" thickness).
- Large, Full Ball Race For Maximum Stability & Smooth Gliding Rotation.
- 360° Interlock Prevents Separation.
- Electro Zinc Coated For Rust Resistance.
- Made in the USA.

PART #	SIZE	CENTER HOLE DIA.	WEIGHT CAPACITY	APPROX. TOP DIA.	CARTON QUANTITY
S8-300C	3" Sq.	1-1/4"	200 lbs.	Up to 18"	100
S8-400C	4" Sq.	2-5/32"	300 lbs.	12" - 25"	100
S8-600C	6" Sq.	4-11/16"	500 lbs.	15" - 30"	100
S8-900C	9" Dia.	4-1/2"	700 lbs.	17" - 35"	25
S8-1200C	12" Dia.	6-9/32"	1000 lbs.	20" & Over	25

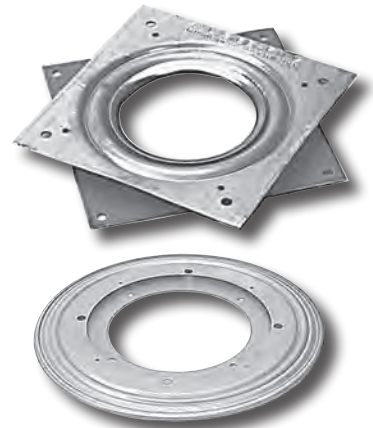

For Larger Applications

ALUMINUM LAZY SUSAN

SOLID ALUMINUM BALL BEARING SWIVELS CONTAIN LOCK SCREW FOR STATIONARY APPLICATION OR FOR SHIPPING

PART #	SIZE	WEIGHT CAPACITY
S8-1300C	13" Dia.	220 lbs.
S8-1600C	16" Dia.	250 lbs.
S8-1800C	17-3/8" Dia.	330 lbs.
S8-2400C	24" Dia.	700 lbs.

PART #	SIZE	WEIGHT CAPACITY	*APPROX. TOP DIA.
S8-1700C	18" Dia.	330 lbs.	24"

*Nonskid feet on upper & lower rail. Drill holes on upper & lower rail.



3M™ HOT MELT BONDING SYSTEMS



PGEC (for 8" sticks)



PGTC-Q (for 8" sticks)



**HELP YOU IMPROVE PRODUCTIVITY,
LOWER COST & MINIMIZE WASTE**

Our new, lightweight, easy-to-use Polygun™ Applicators use Jet-melt™ Adhesives for fast, strong bonds on a variety of surfaces - wood, plastic, foam, fabric, cardboard, rubber and more. (TECHNICAL INFO AVAILABLE UPON REQUEST)

POLYGUN™ APPLICATORS

120 VOLT/150 WATT

HIGH TEMPERATURE APPLICATORS

Deliver up to 3.5 lbs. of adhesive per hour at 385°F

PART #	DESCRIPTION
PGTC-Q	Standard Gun w/Quadrack & Palm Trigger

MULTIPLE TEMPERATURE APPLICATOR

Deliver up to 2.6 to 5.5 lbs. of adhesive per hour at 26.-450°F

PART #	DESCRIPTION
PGEC	Multiple Temperature Gun

Provides multiple temperatures with choice of preset temperature module kits that insert into the handle. Capable of dispensing new low melt Jet-melt™ adhesives.

Jet-melt™ Adhesives

HIGH TEMP GLUE STICKS	PART #	BOX WEIGHT	STICK SIZE	COLOR	HEAT RESISTANCE
	3738	11 lbs.	5/8" x 2"	Tan	130°
3748-Q	11 lbs.	5/8" x 8"	Off White	175°	
3762	11 lbs.	5/8" x 2"	Tan	130°	
3762-Q	11 lbs.	5/8" x 8"	Tan	130°	
3764	11 lbs.	5/8" x 2"	Clear	140°	
3792	11 lbs.	5/8" x 2"	Clear	140°	
3792-Q	11 lbs.	5/8" x 8"	Clear	140°	

LOW TEMP GLUE STICKS	PART #	BOX WEIGHT	STICK SIZE	COLOR	HEAT RESISTANCE
	3762-LM-Q	11 lbs.	5/8" x 8"	Lt. Amber	130°
3792-LM-Q	11 lbs.	5/8" x 8"	Clear	140°	

LOW TEMPERATURE GLUE STICKS

PART #	FEATURES/APPLICATION IDEAS	PART #	FEATURES/APPLICATION IDEAS
3762-LM Lt. Amber	Improved "hot tack" when dispensed at low melt temperature. Can bond beadboard, corrugated, displays.	3792-LM Clear	Long bonding range when dispensed at low melt temperature. Can bond woods, P.O.P. displays, corrugated, polyolefins and other lightweight materials.

HIGH TEMPERATURE GLUE STICKS

PART #	FEATURES/APPLICATION IDEAS	PART #	FEATURES/APPLICATION IDEAS
3738 Tan	High delivery and long bonding range. General purpose for foundry sand cores, exhibits, wood bonding, corrugated and chipboard.	3762 Tan	Excellent "hot tack", fast-setting for corrugated packaging, recoupage, repacking area, warehouse. Low cost, general purpose. Can bond chipboard, wood.
3748 Off White	Good thermal and electrical properties. Non-corrosive to copper. Can bond polypropylene, polyethylene.	3764 Clear	Can bond many plastics. Good impact resistance at low temperature. Can hold ABS, polycarbonate, rigid PVC, polypropylene, polyethylene.
		3792 Clear	Clear multi-purpose product for wood, corrugated, lightweight substrates, furniture, upholstery, novelties. Can bond fabric and other lightweight materials.

3M™ FLEXIBLE ADHESIVES

3M™ Scotch-Grip™ and Fastbond™ brand adhesives are industrial-quality products designed to provide innovative answers to a wide variety of non-structural bonding problems. Some formulations are tailored to specific types of applications; while others are multipurpose and used worldwide in hundreds of different product assembly operations. (TECHNICAL INFO AVAILABLE UPON REQUEST)

30 NF FASTBOND™ CONTACT ADHESIVE, GREEN (PROTECT FROM FREEZING)

A water dispersed high strength contact adhesive that changes color from blue to green when dry. Has high coverage, a long bonding range and good heat resistance. Can be used to bond foamed plastics, plastic laminate, wood, plywood and wood veneer, and canvas to themselves and each other, as well as for postforming operations. Meets requirements of MIL-A-24179-A. Non-flammable in the wet state.

PART #	SIZE	CASE QUANTITY
4276-Q	Quart	12
4276-G	Gallon	4
4276-P	5 Gallon Pail	-

30 NF FASTBOND™ CONTACT ADHESIVE, CLEAR (PROTECT FROM FREEZING)

A water dispersed high strength contact adhesive that has high coverage, a long bonding range and good heat resistance. Can be used to bond foamed plastics, plastic laminate, wood, plywood and wood veneer, and canvas to themselves and each other, as well as for postforming operations. Meets requirements of MIL-A-24179-A. Non-flammable in the wet state.

PART #	SIZE	CASE QUANTITY
4274-Q	Quart	12
4274-G	Gallon	4

MULTI-PURPOSE SPRAY ADHESIVE SYSTEM

STA'-PUT SPH

Colors: Clear & Red

STA'-PUT spray adhesive has been formulated to provide excellent adhesion over a wide range of product applications; securing duct liner, securing duct wrap, board lamination, laminates to laminates, sealing vapor barrier, M.B.I. repair, fire proofing base coat, sealing flex foam, building insulation blocks for a pipe covering operation, mitering fittings & ASJ, FSK, aluminum, PVC to all pipe insulations.

- NON-FLAMMABLE
- COMPLETELY PORTABLE
- NO CLOGGED TIPS
- GUARANTEED SHELF LIFE
- NO FLASHING REQUIRED
- EASY CLEAN UP
- DRIES CLEAR
- WATER RESISTANT
- HIGH TACK
- QUICK SETTING

SPRAY ADHESIVE

PART #	DESCRIPTION	COLOR
SAS-45	15 oz. Can	Clear
SAS-45-R	15 oz. Can	Red
SAS-50	11 lb. Canister	Clear
SAS-50-R	11 lb. Canister	Red
SAS-51	37 lb. Canister	Clear
SAS-51-R	37 lb. Canister	Red

STA'-PUT SPH LIQUID

LIQUID ADHESIVE

PART #	DESCRIPTION	COLOR
SAS-70	5 Gallon Drum	Clear



PERFECT FOR LAMINATES!



STA'-PUT II has been specifically formulated to provide permanent bonding of Styrofoam and all other polystyrene materials with no adverse reaction to the bonded surfaces. Requires 4 minutes to set and bond. Firm pressure is required only during the immediate bonding process.

STA'-PUT II

Colors: Clear & Blue

SPRAY ADHESIVE

PART #	DESCRIPTION	COLOR
SAS-65	13 oz. Can	Clear
SAS-66	30 lb. Canister	Clear
SAS-66-BL	30 lb. Canister	Blue

SP-80 GREEN ADHESIVE

Solvent based, low VOC, non-chlorinated contact adhesive certified for many industry standards



SPRAY ADHESIVE

PART #	DESCRIPTION	COLOR
SP-80-14	14 oz. Spray Can	Clear
SP-80-27	27 lb. Canister	Clear

LIQUID ADHESIVE

PART #	DESCRIPTION	COLOR
SP-80-5	5 gal. Pail Drum	Clear

"PRO" SPRAY GUN

PART #	DESCRIPTION
SG200	Spray Gun
ST6502	Adjustable Tip
MH973	12' Hose
MH974	18' Hose
MH978	25' Hose

STA'-PUT SPH/II REMOVER

PART #	DESCRIPTION
SAS-46	15 oz. Can

PLEASE NOTE: STA'-PUT ADHESIVES CAN ONLY BE SHIPPED VIA RPS!

DOUBLE COATED ADHESIVE TAPES



High-strength Scotch™ VHB tapes are used throughout the industry today to replace screws, rivets, welding, liquid adhesives and other permanent assembly methods. They offer greater design flexibility and are often the key to dramatic improvements in styling and performance. Moreover, they allow faster, easier assembly, eliminate cleanup & increase profits. (TECHNICAL INFO AVAILABLE UPON REQUEST)

3M™ BRAND VHB™ HIGH STRENGTH ACRYLIC FOAM TAPE

Clear, closed cell acrylic foam carrier - excellent for joining transparent materials.

PART #	THICKNESS	WIDTH	ROLL SIZE	CASE QUANTITY
4905-0500		1/2"	72	18
4905-0750	.020	3/4"	Yds.	12
4905-1000		1"		9
4910-0500		1/2"	36	18
4910-0750	.040	3/4"	Yds.	12
4910-1000		1"		9

Very conformable gray closed cell acrylic foam tape 45 mill thick, paper liner.

PART #	CASE QUANTITY
4941-0500	18
4941-0750	12
4941-1000	9

White, closed cell acrylic foam carrier - features an all-purpose adhesive.

PART #	THICKNESS	WIDTH	ROLL SIZE	CASE QUANTITY
4930-0500		1/2"	72	18
4930-0750	.025	3/4"	Yds.	12
4930-1000		1"		9
4950-0500		1/2"	36	18
4950-0750	.045	3/4"	Yds.	12
4950-1000		1"		9

Very conformable black closed cell acrylic foam tape 45 mill thick, PE liner.

PART #	ROLL SIZE	CASE QUANTITY
5952-0500	36 Yds.	18
5952-0750	15 Yds.	12
5952-1000	36 Yds.	9

3M™ RUBBER-BASED POLYETHYLENE FOAM TAPE

*Available in Black or White

PART #	THICKNESS	WIDTH	ROLL SIZE	CASE QUANTITY
4462-0500*		1/2"	72	18
4462-0750*	.030	3/4"	Yds.	12
4462-1000*		1"		9

PART #	THICKNESS	WIDTH	ROLL SIZE	CASE QUANTITY
4466-0500*		1/2"	36	18
4466-0750*	.060	3/4"	Yds.	12
4466-1000*		1"		9

PLEASE NOTE: ABOVE TAPES ARE STOCK ITEMS.

OTHER SCOTCH™ BRAND ADHESIVE TAPES ARE AVAILABLE PLEASE INQUIRE FOR LEAD TIMES

RUBBER-BASED DOUBLE COATED ADHESIVE TAPES

POLYETHYLENE FOAM TAPE

ROLLS

Available 1/32" or 1/16" thick
- 1/2", 3/4" or 1" Wide
- White or Black
- 216 Ft. Rolls



1/32" THICK

PART #	WIDTH	ROLLS PER CASE
RFT1-0500-	1/2"	24
RFT1-0750-	3/4"	16
RFT1-1000-	1"	12

1/16" THICK

PART #	WIDTH	ROLLS PER CASE
RFT2-0500-WH	1/2"	24
RFT2-0750-WH	3/4"	16
RFT2-1000-WH	1"	12

DOTS

Available 1/32" or 1/16" thick
- 1/2", 3/4" or 1" Wide
- White Only



1/32" THICK

PART #	DIA.
RFT1-120	1/2"
RFT1-340	3/4"
RFT1-100	1"

1/16" THICK

PART #	DIA.
RFT2-120	1/2"
RFT2-340	3/4"
RFT2-100	1"

CLEAR FILM TAPE

- .5mil polyester film with 2mil adhesive
- Rubber based adhesive not recommended for direct UV exposure applications
- Application temperature: 65°F-100°F
- Service temperature: -20°F-150°F
- Roll core: 3" Diameter -180 Ft.

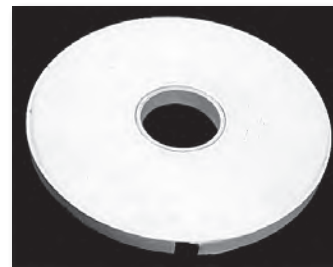

PART

DK-0500
DK-0750
DK-1000

BINNING STRIPS

OUR BINNING STRIP MAKES IT EASY TO ADJUST SPACING & ACCOMMODATE YOUR NEEDS

Material: Ivory, White, Black & Clear Styrene

Versatile plastic band strip can be installed on counters, tables, cabinets, in drawers - anywhere. Accepts various types of dividers. Economical yet easily installed.

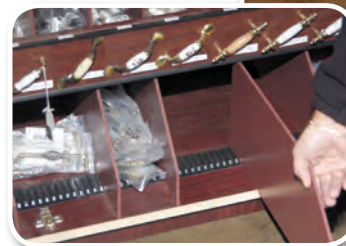
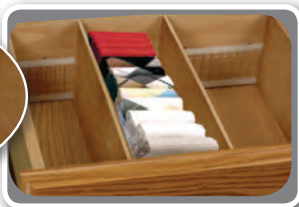

STANDARD BABY BINNING STRIP

FOR 1/4" DIVIDER

Works independently of standard binning strip

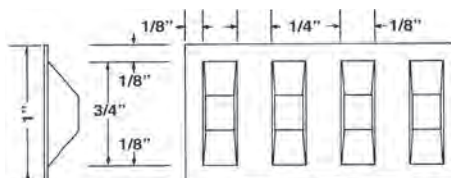

PART #	DESCRIPTION
292-BK-60	60"-Black-No adhesive
292-CL-60	60"-Clear-No adhesive
292-IV-60	60"-Ivory-No adhesive
292-WH-60	60"-White-No adhesive
292A-BK-60	60"-Black-w/adhesive
292A-CL-60	60"-Clear-w/adhesive
292A-IV-60	60"-Ivory-w/adhesive
292A-WH-60	60"-White-w/adhesive

STANDARD BINNING STRIP

FOR 1/4" DIVIDER

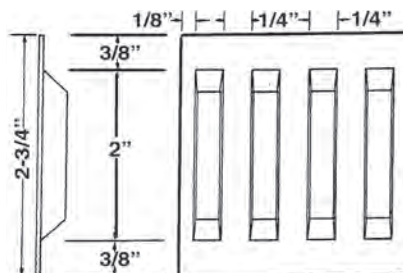
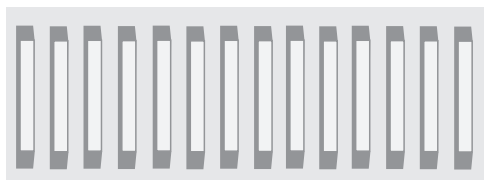

PART #	DESCRIPTION
282-CL-48	48"-Clear-No adhesive
282-CL-60	60"-Clear-No adhesive
282-IV-48	48"-Ivory-No adhesive
282-IV-60	60"-Ivory-No adhesive
282-WH-48	48"-White-No adhesive
282-WH-60	60"-White-No adhesive
282-BK-60	60"-Black-No adhesive
282A-CL-48	48"-Clear-w/adhesive
282A-CL-60	60"-Clear-w/adhesive
282A-IV-48	48"-Ivory-w/adhesive
282A-IV-60	60"-Ivory-w/adhesive
282A-WH-48	48"-White-w/adhesive
282A-BK-48	48"-Black-w/adhesive
282A-WH-60	60"-White-w/adhesive
282A-BK-60	60"-Black-w/adhesive

STANDARD BINNING STRIP

FOR 1/8" DIVIDER

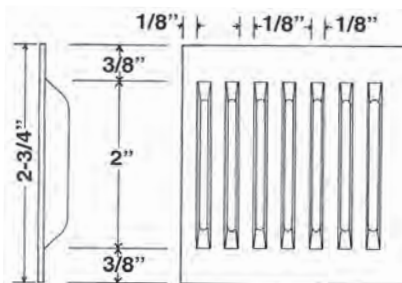
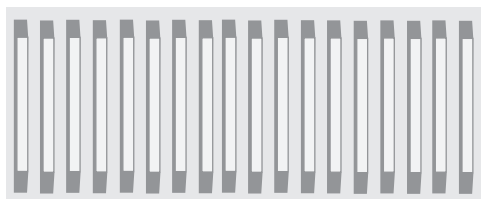

PART #	DESCRIPTION
182-CL-60	60"-Clear-No adhesive
182-IV-60	60"-Ivory-No adhesive
182-WH-60	60"-White-No adhesive
182-BK-60	60"-Black-No adhesive
182A-CL-60	60"-Clear-w/adhesive
182A-IV-60	60"-Ivory-w/adhesive
182A-WH-60	60"-White-w/adhesive
182A-BK-60	60"-Black-w/adhesive

DRAWER ESSENTIALS

SOLID BIRCH DRAWER PARTS

Material: Solid Birch Drawer Construction Components with Clear Catalyzed Finish (Natural Light)

Sides and fronts/back are 5/8" solid edge glued birch components. Straight and true, our drawer components are finished with a durable UV coating and available in 6 sizes for any drawer application. Side lengths are 22" (558.8mm) and fronts/back are 96" (2438.4mm). Drawer bottoms are also available in 5mm Birch Plywood (BIBB grade).

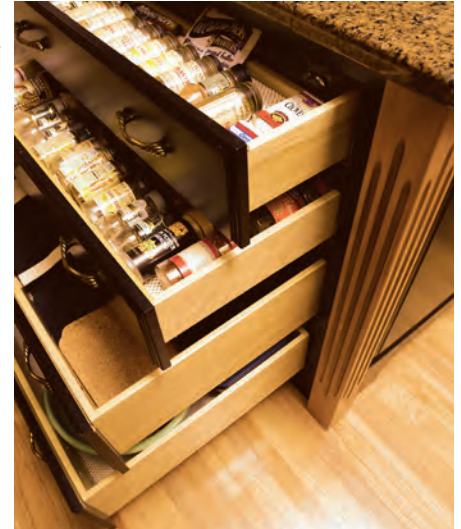
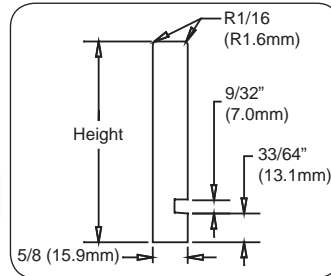

DRAWER SIDES, FRONTS, BACKS

DRAWER SIDES

PART #	HEIGHT	LENGTH	BOX QTY.
DS-2-BIR	2-1/2"	22"	20 pcs.
DS-3-BIR	3-1/2"	22"	20 pcs.
DS-4-BIR	4"	22"	20 pcs.
DS-6-BIR	6"	22"	20 pcs.
DS-8-BIR	8"	22"	10 pcs.
DS-10-BIR	10"	22"	10 pcs.
* DS-10-BIR-NG	10"	22"	10 pcs.

* Products with an NG part number are supplied with no groove and have a finished radius on both sides for custom heights.

DRAWER FRONTS/BACKS

PART #	HEIGHT	LENGTH	BOX QTY.
DF-2-BIR-8	2-1/2"	96"	5 pcs.
DF-3-BIR-8	3-1/2"	96"	5 pcs.
DF-4-BIR-8	4"	96"	5 pcs.
DF-6-BIR-8	6"	96"	5 pcs.
DF-8-BIR-8	8"	96"	3 pcs.
DF-10-BIR-8	10"	96"	3 pcs.
* DF-10-BIR-NG-8	10"	96"	3 pcs.

* Products with an NG part number are supplied with no groove and have a square edge on both sides for custom heights.



DRAWER BOTTOM

DRAWER BOTTOM

PART #	HEIGHT	LENGTH	BOX QTY.
DB-2160	21-7/8"	60"	3 pcs.

Ends can be joined by gluing, nailing or cutting out dovetail joinery.

RUNNER WHEEL

Material: Nylon

- Simple - Cost Effective
- Eliminates need for drawer slides
- Ideally suited for applications limited in space



PART #	COLOR
OP-0900	Black
0900	Brown

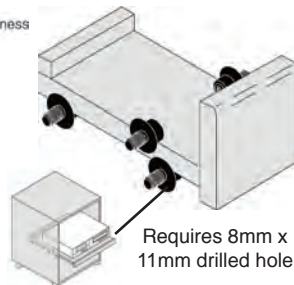

DRAWER FRONT ADJUSTER

Material: Nylon

Use on drawer fronts to provide realignment facility on fronts attached to 4-sided drawers. Housing is nylon with die cast threaded insert screw, plated steel. Housing is hammer driven into a 25MM prebored hole. Screw attaches 4th side of drawer to allow adjustment of front until fully tightened. Screw size is 7/8" x 8/32". **Features:** 2mm of adjustment in vertical or horizontal directions. 25mm hole boring in drawer front. Large head screw attachment to 4th side of drawer. Simple to use.



PART #	COLOR
6310-BR	Brown

DRAWER ESSENTIALS

DRAWER DIVIDERS

Material: Clear Polycarbonate



- Holds 1/2" material
- Can be screw mounted or applied with adhesive

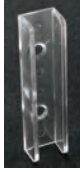
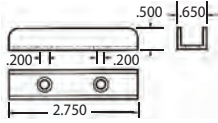

PART #	COLOR	DESCRIPTION
R83-941CL	Clear	Screw Mount
R83-941CL-A	Clear w/Adh	Adhesive

FLEXA-TOUCH®

Material: Natural ABS

- Designed to allow drawers to be opened just by pushing on the front
- Adjust for flush alignment from 7/8" to 3" max
- Screws included



PART #
OI-1021

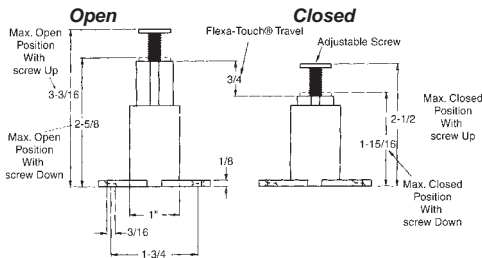

DRAWER BUMPERS

Material: Polyethylene



- Put bumpers on drawers to prevent damage to cabinet doors



PART #	COLOR	THICKNESS
R51-DB51-WH	White	29/64" (11.5mm)
R51-DB51-BE	Beige	29/64" (11.5mm)
R51-DB18-WH	White	23/32" (18mm)
R51-DB18-BE	Beige	23/32" (18mm)

UNDERMOUNT ROLLOUT BUMPERS

Material: Polyethylene



- Ideally suited for use with drawers utilizing undermount slides
- When used, will prevent damage to cabinet doors



PART #	COLOR
R51-C47-WH	White
R51-C47-BE	Beige

DRAWER DIVIDER CLIPS

Material: Delrin

- Spring action design will securely hold divider panels up to 1/4" thick

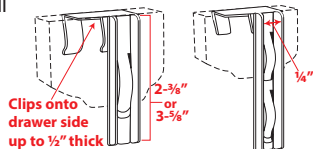

PART #	COLOR	LENGTH
R83-6200-BK	Black	2-3/8" L
R83-6230-BK	Black	3-5/8" L

Corner Braces can be found on page 286

DRAWER DIVIDER SUPPORTS

Material: Polyethylene

- Groove type - for 1/4" - 5/16" drawer dividers
- Supports are installed in grooves in drawer side.
- Divider may be adjusted by removing it and relocating the supports.

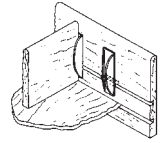
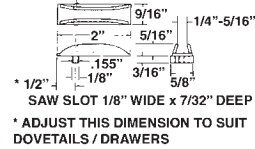

PART #	COLOR
R83-190BE	Beige

REMOVABLE DRAWER OUTSTOP

Material: Polypropylene

- Mount on back of drawer to prevent from pulling out
- Tip out stop forward to remove & upon reinsertion merely push the drawer all the way in & it will automatically snap into place

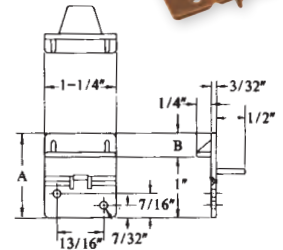
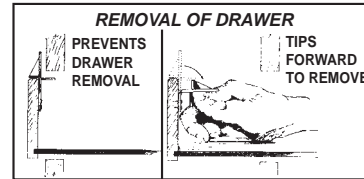

PART #	COLOR	A	B
R51-423BE	Beige	1-3/4"	3/4"
R51-424BE	Beige	2"	1"
R51-468BE	Beige	1-3/8"	3/8"

SCREW PART #
SCR-6500FHZ
#6 x 1/2" Flat Head Zinc

FALSE DRAWER FRONT CLIPS



- Used to attach finished fronts to cabinet that will have limited use
- Also, ideal for access panels that must be removable yet secure
- Use #6 screw x 1/2" (sold separately below)

Material: ABS

False Front Clip for 4-1/2" Opening

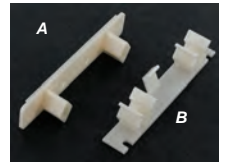
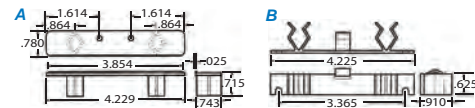

PART #	COLOR
FFDC-30	Natural

Material: Polycarbonate

False Front Clip with 1" Mounting Plate



PART #	COLOR
FFDC-10	Clear

SCREW PART #
SCR-6500PHZ
#6 x 1/2" Flat Head Zinc

DRAWER ESSENTIALS

Cut Program Available
SEE PAGE 29 FOR DETAILS

PLASTIC HANGING FILE FOLDER MOULDINGS

LENGTHS: 8 FT.

Material: Styrene

Fits 1/2"

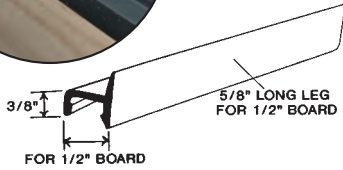
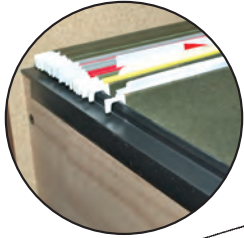

PART #	COLOR
115-BK-8	Black
115-WH-8	White
115-BE-8	Beige

115-2078-BK

Fits 1/2"

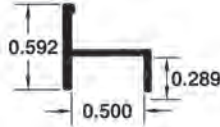

Material: Black Rigid PVC

115-2182-BK

Fits 1/2"

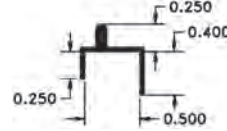

115-2180-BK

Fits 5/8"

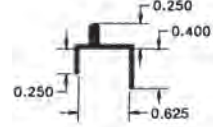

115-2132-BK

Fits 1/2"

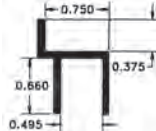

2132-CLIP

works with
115-2132-BK

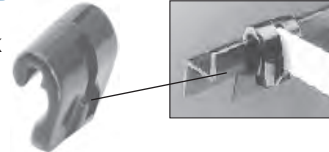

FILE BAR HOLDERS

Material: Black Acetate

- Fits Up To 1/2" Thick Drawer Sides
- Holds 1/8" x 1/2" File Bar

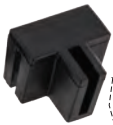

R83-6100-BK

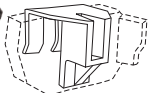

R83-6120-BK

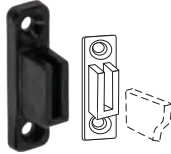

R83-6130-BK

PART #	DESCRIPTION	DIMENSIONS
R83-6100-BK	Hanging File Bar Holder	1-1/8" H x 15/16" W
R83-6120-BK	Screw Mount File Bar Holder	1-5/8" H x 1/2" W
R83-6130-BK	90° File Bar Holder	7/16" H x 15/16" W

PENDA FLEX BAR RECTANGULAR BAR

Material: Aluminum • Lengths: 8 Ft.

Finishes Available

- *M - Mill - Dull Finish: As Extruded - May or May Not Have "Scratches"/Die Lines
- *BK - Black - Powder Coated **New**



PART #	A	B	Length	Mill	Black
ALU599-18-*	1/2"	1/8"	120 Ft.	600 Ft.	
New ALU600-18-*	3/4"	1/8"	120 Ft.	600 Ft.	

LOCKS

BASIC CAM

MINIATURE TUBULAR PUSH LOCK **New**



PART #
RA713-CHR-KA

- Material: Zinc Alloy
- Chrome plated finish
- Size: 3/8" L x 7/16" Diameter
- Drawer Thickness: 1/4"
- Keyed alike only
- Comes with 2 keys



PART #
RA709-CHR-KA

CAM LOCK

- Material: Metal construction
- Chrome plated finish
- Size: 7/8"
- Drawer Thickness: Up to 5/8" panel
- Keyed alike only

Spare Keys for RA709-CHR-KA
#KY-135...set of two

DRAWER LOCKS

SLIDING GLASS SHOWCASE DRAWER LOCK

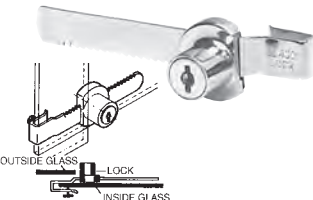

PART #
RA710-CHR-KA

- Material: Metal construction
- Chrome plated finish
- Size: 5-1/2" Ratchet bar
- Drawer Thickness: From 3/16" to 1/4" glass panel
- Keyed alike only

Spare Keys for RA710-CHR-KA
#KY-035...set of two

DRAWER LOCK



PART #
RA711-CHR-KA

SCREW
PART #

SCR-6625PHZ
#6 x 5/8" Pan Head Zinc

- Material: Metal construction
- Chrome plated finish
- Size: 2-1/2" W x 1-1/2" H
- Drawer Thickness: 7/8"
- Keyed alike only

Spare Keys for RA711-CHR-KA
#KY-101...set of two

LOCKS

DRAWER LOCKS

DRAWER LOCK For Wooden Doors

New

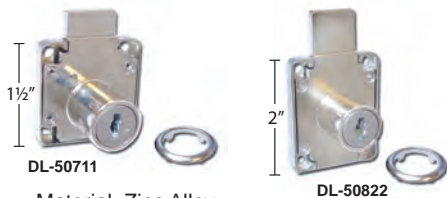

- Material: Zinc Alloy
- Nickel finish
- Size: **DL-50711:** 1-1/2" x 1-1/2" x 1/4" thick
DL-50822: 1-1/2" x 2" x 1/4" thick
- Drawer Thickness: 20mm wooden drawer
- Keyed alike only
- Comes with 2 keys
- Use #5 wood screws, (Not included)

PART #	SIZE
DL-50711-CHR	1-1/2" x 1-1/2"
DL-50822-CHR	1-1/2" x 2"

PUSH LOCK For Sliding Cabinet Doors



- Material: Zinc Die Cast
- Polished Chrome finish
- Size: 7/8" Depth
- Keyed alike only
- Comes with screws and cup strike

PART #
PL-10

SCREW PART #
SCR-6625PHZ

#6 x 5/8" Pan Head Zinc

PUSH LOCK For Wooden Drawers

New



- Material: Zinc Alloy
- Size: 3/4" Hole required, overall 3/4" x 2"
- Drawer Thickness: 5/8" - 3/4"
- Keyed alike only
- Comes with 2 keys
- Use #5 wood screws, (Not included)

PART #	COLOR/FINISH
PL-604-BK	Black
PL-604-CHR	Chrome

LOCK AIDS

PADLOCKABLE CAM LOCK

New



- Material: Zinc Alloy
- Size: 1.31" Cylinder length, 3/4" Diameter
- Drawer Thickness: Up to 7/8"
- Built in finger pull

PART #	FINISH
GL-7840D-BK	Matte Black
GL-7840D-CHR	Chrome

ECONOMY PADLOCKABLE CAM LOCK

New



- Material: Zinc Alloy
- Chrome finish
- Size: 1-1/8" Cylinder length, 3/4" Diameter
- Drawer Thickness: Up to 7/8"

COMBINES CAM LOCK WITH FLEXIBILITY OF A PADLOCK

PART #
GL-7840E-CHR

BLACK THUMB TURN CAM LOCK

New



- Material: Zinc Alloy
- Black/Chrome finish
- Size: 5/8" L x 3/4" Diameter
- Drawer Thickness: Up to 3/8"
- Spun on 1-1/8" straight cam, 90° turn

PART #
CAM-0742

DECO-HASP

Material: Acrylic DR101 (Clear), ABS (Black)

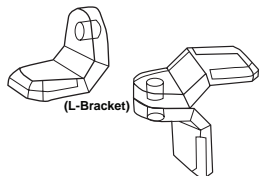

Innovative locking hasp designed for corner or flat applications. No moving parts reduce breakage in the field. Solvent bonds to acrylic, polycarbonate, ABS and styrene.

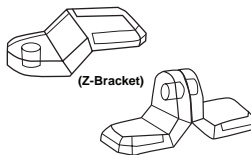

PART #	DESCRIPTION
DECO-HASP-LCL	Clear Acrylic 7/8" L x 3/4" W x 3/4" H Flat Mount Hasp
DECO-HASP-LBK	Black ABS 7/8" L x 3/4" W x 3/4" H Flat Mount Hasp
DECO-HASP-ZCL	Clear Acrylic 1-3/8" L x 3/4" W x 7/16" H Corner Mount Hasp
DECO-HASP-ZBK	Black ABS 1-3/8" L x 3/4" W x 7/16" H Corner Mount Hasp

ACRYLIC HASP

- Color: Clear, Black or White
- 2-3/8" Long x 1-1/16" Wide x 1/8" Thick

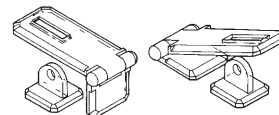

Bottom section of hasp is reversible for either corner or flat mounting.
Pre-determine assembly before inserting pin completely!

PART #	COLOR
HSP-110-CL	Clear
HSP-110-BK	Black
HSP-110-WH	White

COMBINATION CAM LOCK

New



- Material: Zinc Alloy
- Chrome finish
- Size: 1-1/8" Cylinder
- Drawer Thickness: Up to 7/8"
- Screws included
- Master key override and code discovery

PART #
COM-CAM-7432

2 Keys & Change Pin for COM-CAM-7432
#7432-KEYS

COMBINATION LOCKS 4 DIGIT COMBINATION LOCK

New



- Material: Zinc and Plastic
- Nickel finish
- Size: 4-3/8" x 3-1/8"
- Drawer Thickness: For 1mm - 28mm thick plate
- Comes with 2 keys
- Screws included

PART #
COM-LOK-DL01

COMBINATION RATCHET LOCK

New



- Material: Zinc Alloy
- Black/Chrome finish
- Size: 5-3/8" Ratchet bar
- Glass Thickness: 1/2"
- Master key included

PART #
RA-7860S

PULL OUT PENCIL DRAWER

UNDER THE DESK STORAGE SOLUTIONS

FEATURES	1	2	3	4
Black	✓	✓	✓	✓
Silver				✓
Contoured Handle for easy access	✓			
Centrally located finger tab for easy opening			✓	
Designed to fit desks with shorter depth	✓	✓		
Narrow Width	✓			✓
Wide Width		✓	✓	
Pen/Pencil compartments with plastic tray	✓	✓	✓	✓
Ball Bearing Slides			✓	
Roller Slide with Plastic Tray	✓	✓		
Screw Mount - Rotates				✓
Mounting Hardware	✓	✓	✓	✓
Built in Tape Dispenser				✓
Made in U.S.A.	✓		✓	✓



1 PART # PDN-1BK
DIMENSIONS: 17.956"L x 12.75"W x 2.34"D

New



2 PART # PDW-1BK
DIMENSIONS: 16.125"L x 22.40"W x 2.05"D

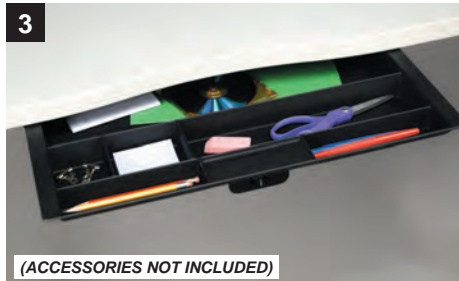

3 PART # PDW-2BK
DIMENSIONS: 19.19"L x 21.39"W x 2.05"D



4 PART # PDR-451*
DIMENSIONS: 13.625"L x 8.25"W x 1.375"D

*Available in Black (BK) or Silver (SL)

UTILITY TRAYS

STYRENE • BLACK

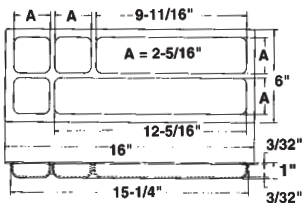

PART # COLOR
R11-82BK Black

STYRENE • BEIGE OR BLACK

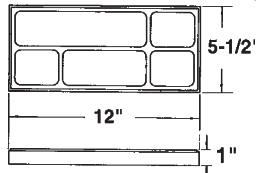

PART # COLOR
R11-90BK Black

STYRENE • BEIGE OR BLACK

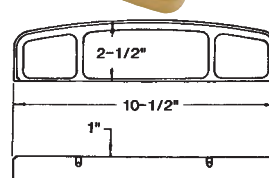

PART # COLOR
R11-87BE Beige
R11-87BK Black

STYRENE • BEIGE OR BLACK



PART # COLOR
R11-194BK Black
R11-197BK Black

ORGANIZER GROMMET

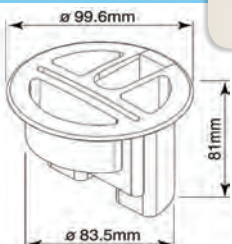

Black Only

PART #
BK8865



KEYBOARD TRAYS

FEATURES	1	2	3	4
Reversible mouse tray for right or left hand users		✓	✓	✓
Gel wrist rest			✓	✓
Gel mouse pad			✓	✓
Pen/pencil storage		✓		
Contoured wrist support	✓	✓		
Fully articulates: swivels and retracts				✓
Slides on track				✓
Ball bearing slides	✓	✓	✓	
Includes all mounting hardware	✓	✓	✓	✓
Made in the U.S.A.	✓	✓	✓	✓



(KEYBOARD NOT INCLUDED)

PART # **COLOR**

CT24-BK Black

DIMENSIONS:

18.23"L x 19.95"W x 3.90"D



PART # **COLOR**

CT36-BK Black

DIMENSIONS:

18.20"L x 26.26"W x 3.90"D



PART # **COLOR**

CT48-BK Black

DIMENSIONS:

18.20"L x 26.38"W x 3.90"D



(KEYBOARD NOT INCLUDED)

PART # **COLOR**

CT-EKS-BK Black

DIMENSIONS:

12.40"L x 26.38"W x 8.53"D (lowest)

PENCIL & NOTEBOOK DRAWERS

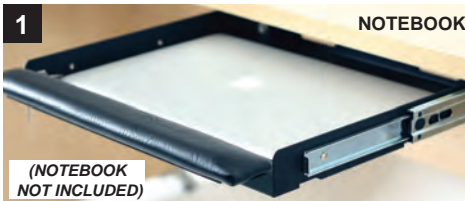

NOTEBOOK

(NOTEBOOK NOT INCLUDED)

PART # **COLOR**

NT-894 Black

MATERIAL: Steel

DIMENSIONS: 16.03"L x 17.11"W x 2.0625"D

FEATURES	1	2	3	4
Ball bearing slides	✓	✓	✓	✓
Lockable	✓			
Wrist rest	✓			
Wire management slots	✓			
Includes all mounting hardware	✓	✓	✓	✓
Made in the U.S.A.	✓	✓	✓	✓



PENCIL

PART # **COLOR**

PT-897 Black

MATERIAL: High Impact Polystyrene

DIMENSIONS: 19.19"L x 21.29"W x 1-7/8"D



PENCIL

PART # **COLOR**

PT-8931 Black

MATERIAL: High Impact Polystyrene

DIMENSIONS: 17.95"L x 12.75"W x 2-3/4"D



PENCIL

PART # **COLOR**

PT-893 Black

MATERIAL: High Impact Polystyrene

DIMENSIONS: 16.25"L x 21.375"W x 1.875"D

INSERT HOLDER

PRODUCT FEATURES:

- Material: ABS
- Color: Black
- 1/4" lip area
- Friction fit molded ribs.
- Can be used as a cup holder or a paper clip holder.
- Other colors may be available. Minimums apply - please inquire.



Drill Hole Size

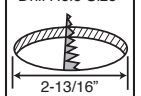

36BKS

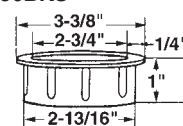

36BKD

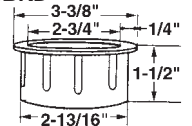

PART # **DRILL HOLE DIAMETER**

36BKS 2-13/16"

36BKD 2-13/16"

JUST A SLIGHT PULL IS ALL YOU NEED

- **Material:** Steel with Plastic Mechanisms
- Easily pulls open & closes with the Grass soft-close dampening system.
- Full extension with synchronized mechanism.
- Each pair of slides is handed- 1 left & 1 right.
- For use with up to 5/8" drawer material.



DYNAPRO 2-D STANDARD DUTY FULL EXTENSION SOFT CLOSE DRAWER FACE FRAME OR FRAMELESS APPLICATION



PRODUCT FEATURES:

- Integrated 2-dimensional adjustment for alignment- height + 3.5 mm & side ± 1.5 mm
- 100 lb. static load capacity, 88 lb. dynamic load capacity
- Each set includes slides, left & right front fixing brackets, and two rear mount brackets (rear mount brackets required for face frame applications only).

PART #	DRAWER LENGTH	CABINET DEPTH	INTERIOR CABINET DEPTH	
			MINIMUM	MAXIMUM
OI-DP2D-9	9"	12"	11-15/32"	11-3/4"
OI-DP2D-12	12"	15"	12-7/8"	14-9/16"
OI-DP2D-15	15"	18"	15-7/8"	17-9/16"
OI-DP2D-18	18"	20"	18-27/32"	20-9/16"
OI-DP2D-21	21"	24"	21-27/32"	23-17/32"

DYNAPRO 3-D HEAVY DUTY FULL EXTENSION SOFT CLOSE DRAWER SLIDES



PRODUCT FEATURES:

- **For Frameless Application**
- Integrated 3-dimensional adjustment for alignment- height + 3.5 mm, side ± 1.5 mm & tilt + 4.0 mm
- 132 lb. dynamic load capacity
- Each set includes slides, left & right front fixing brackets, and left & right rear adjustment brackets

PART #	DRAWER LENGTH	NOMINAL LENGTH	MINIMUM CABINET DEPTH
OI-DP3D-18	18"	18-11/16"	18-27/32"
OI-DP3D-21	21"	21-11/16"	21-27/32"
OI-DP3D-24	24"	24-23/32"	24-7/8"
OI-DP3D-27	27"	27-23/32"	27-7/8"
OI-DP3D-30	30"	30-23/32"	30-7/8"

ACCESSORIES

PENINSULA BRACKETS

- **Material:** ABS
- OI-242**



REAR UNDERMOUNT INSET SOCKET

- **Material:** ABS
- OI-276**



REAR UNDERMOUNT OVERLAY SOCKET

- **Material:** ABS
- OI-280**



SPACER

- **Material:** ABS
- OI-3640**

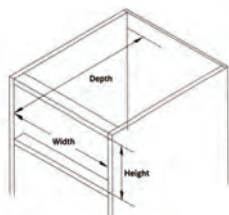

Frameless

TO CALCULATE OUTSIDE DRAWER WIDTH

Face Frame

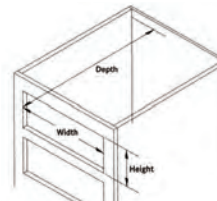

Deduct drawer sides width times 2 from inside cabinet width

Calculation Outside Drawer Width				
Drawer side thickness	16 (5/8")	15 (9/16")	14 (9/16")	13 (1/2")
Deduct from inside cabinet width	10 (3/8")	12 (1/2")	14 (9/16")	16 (5/8")

75 LB. FULL EXTENSION SOFT CLOSE CONCEALED UNDERMOUNT SLIDE

OI-4100 SERIES

FOR USE WITH UP TO 5/8" DRAWER MATERIAL

Rear Mounting Bracket

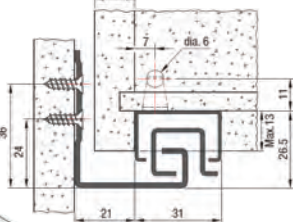
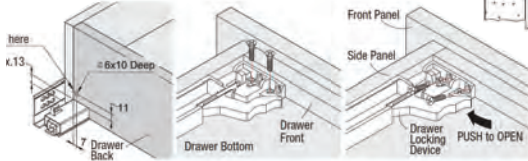
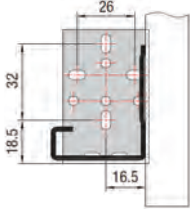

PRODUCT FEATURES:

- Galvanized Steel
- Has great smooth running qualities
- Can be used with Frameless or Face Frame cabinets
- Easy close device prevents slamming
- Each set includes slides, front mounting clips and rear mounting brackets

PART #	LENGTH	LOAD RATING
OI-4100-12	12"	85 lbs.
OI-4100-15	15"	80 lbs.
OI-4100-18	18"	80 lbs.
OI-4100-21	21"	75 lbs.

ACCESSORIES

REAR UNDERMOUNT SOCKET

- Material: ABS
- OI-680



SPACER

- Material: ABS



MOUNTING SCREWS SOLD SEPARATELY

16 pieces required per pair
SCR-6625FHZ



See page 300 for our complete screw line

BINNING STRIP FOR DRAWERS

Material: Ivory, White, Black & Clear Styrene



STANDARD BINNING STRIP FOR 1/4" DIVIDER

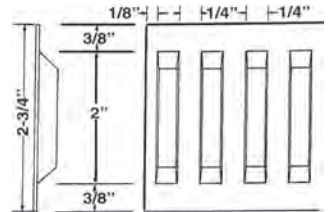

STANDARD BABY BINNING STRIP FOR 1/4" DIVIDER

Works independently of standard binning strip

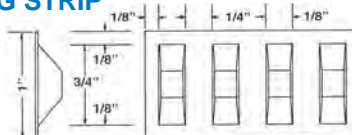

PART #	DESCRIPTION
292-BK-60	60"-Black-No adhesive
292-CL-60	60"-Clear-No adhesive
292-IV-60	60"-Ivory-No adhesive
292-WH-60	60"-White-No adhesive
292A-BK-60	60"-Black-w/adhesive
292A-CL-60	60"-Clear-w/adhesive
292A-IV-60	60"-Ivory-w/adhesive
292A-WH-60	60"-White-w/adhesive



PART #	DESCRIPTION
282-CL-48	48"-Clear-No adhesive
282-CL-60	60"-Clear-No adhesive
282-IV-48	48"-Ivory-No adhesive
282-IV-60	60"-Ivory-No adhesive
282-WH-48	48"-White-No adhesive
282-WH-60	60"-White-No adhesive
282-BK-60	60"-Black-No adhesive
282A-CL-48	48"-Clear-w/adhesive
282A-CL-60	60"-Clear-w/adhesive
282A-IV-48	48"-Ivory-w/adhesive
282A-IV-60	60"-Ivory-w/adhesive
282A-WH-48	48"-White-w/adhesive
282A-BK-48	48"-Black-w/adhesive
282A-WH-60	60"-White-w/adhesive
282A-BK-60	60"-Black-w/adhesive

STANDARD BINNING STRIP FOR 1/8" DIVIDER

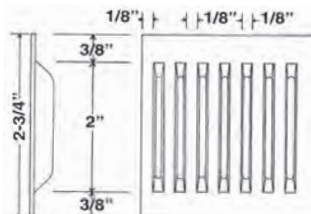
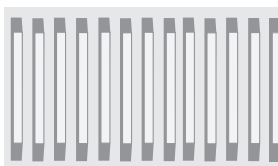

PART #	DESCRIPTION
182-CL-60	60"-Clear-No adhesive
182-IV-60	60"-Ivory-No adhesive
182-WH-60	60"-White-No adhesive
182-BK-60	60"-Black-No adhesive
182A-CL-60	60"-Clear-w/adhesive
182A-IV-60	60"-Ivory-w/adhesive
182A-WH-60	60"-White-w/adhesive
182A-BK-60	60"-Black-w/adhesive

100 LB. LOW PROFILE FULL EXTENSION DRAWER SLIDE

OI-5043 SERIES

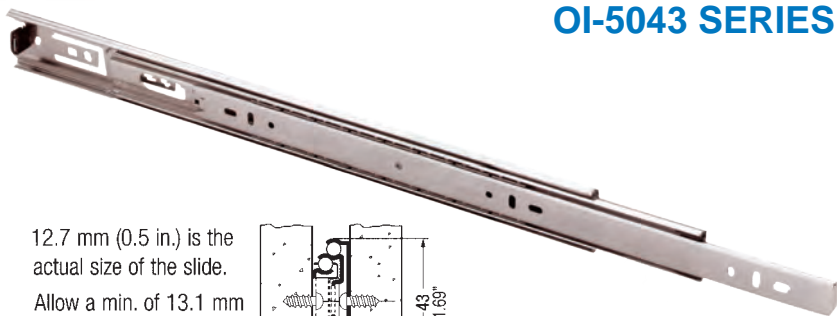

12.7 mm (0.5 in.) is the actual size of the slide.
Allow a min. of 13.1 mm (0.52 in.) for clearance.

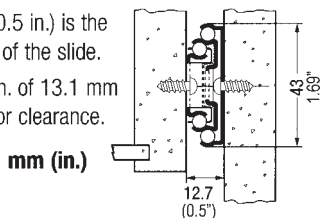

PRODUCT FEATURES:

- Available Lengths: 10"-28"
- Material: Cold rolled steel with steel ball bearings
- Finish: Clear Zinc
- Side mounted with trigger release
- Low profile for shallow drawers and traditional desks
- Low profile, only 43 mm (1.69" height)
- 100 lbs. Load Rating
- Full extension travel
- 1/2" side spacing
- Trigger release design
- Face Frame hole
- 32 mm screw mounting system

PART #	LENGTH	LOAD RATING	CARTON SIZE
OI-5043-10	10"	120 lbs.	10 Pairs
OI-5043-12	12"	120 lbs.	10 Pairs
OI-5043-14	14"	115 lbs.	10 Pairs
OI-5043-16	16"	110 lbs.	10 Pairs
OI-5043-18	18"	105 lbs.	10 Pairs
OI-5043-20	20"	100 lbs.	10 Pairs
OI-5043-22	22"	95 lbs.	10 Pairs
OI-5043-24	24"	90 lbs.	10 Pairs

MOUNTING SCREWS SOLD SEPARATELY

16 pieces required per pair
SCR-6625FHZ



See page 300 for our complete screw line

ACCESSORIES

PENINSULA BRACKETS

- Material: Steel & ABS
- OI-679



REAR MOUNT METAL SOCKET

- Material: Steel & ABS
- OI-5043B-S



SPACER

- Material: ABS
- OI-3616



EASY CLOSE SOFT CLOSE DAMPENING SYSTEM

Works with any drawer slide.

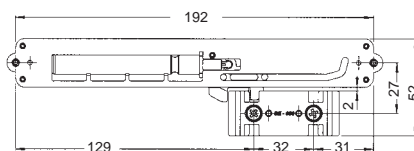
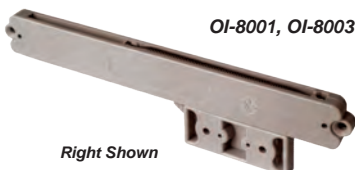
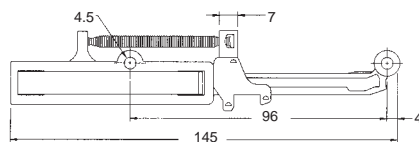
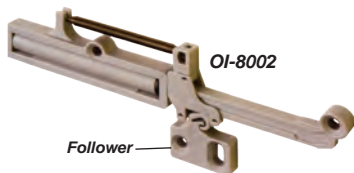

PRODUCT FEATURES:

- Material: Grey high impact polystyrene
- 3 models available to accommodate side clearance
- .39" (10 mm) - .53" (13.5 mm)
- Drawer is softly dampened & pulled shut without slamming
- All mounting hardware & installation instructions included

PART #	DRAWER WEIGHT	SIDE CLEARANCE	PACKING
OI-8002	Up to 40 lbs.*	.39" (10 mm) - .53" (13.5 mm)	Per Piece
OI-8001	Up to 75 lbs.	.49" (12.5 mm)	Per Pair
OI-8003	Up to 150 lbs.	.49" (12.5 mm)	Per Pair

*NON-HANDED-USE 2 PIECES FOR DRAWERS UP TO 80 LBS.

ECONOMY 100 LB. FULL EXTENSION SLIDE

WITH 1" OVER TRAVEL

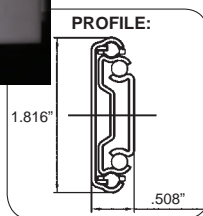

PRODUCT FEATURES:

- Standard with 1" over travel
- Available Lengths: 10" - 28"
- Finish: Clear Zinc
- Side mounted with release latch for easy disconnect
- Hold in detent
- 1/2" side spacing
- Load rating: 100 lbs./pair (22" length)
- Screw mounting system 32mm compatible
- 1/2" side clearance
- Comparable with Dynaslide® 4634, Accuride® 3834 and Knappe & Vogt® 8405

PART #	LENGTH	LOAD RATING	RECOMMENDED DRAWER WIDTH	CARTON SIZE
OI-9400-10	10"	120 lbs.	10"	10 Pairs
OI-9400-12	12"	115 lbs.	12"	10 Pairs
OI-9400-14	14"	110 lbs.	14"	10 Pairs
OI-9400-16	16"	105 lbs.	16"	10 Pairs
OI-9400-18	18"	100 lbs.	18"	10 Pairs
OI-9400-20	20"	100 lbs.	20"	10 Pairs
OI-9400-22	22"	100 lbs.	22"	10 Pairs
OI-9400-24	24"	85 lbs.	24"	10 Pairs
OI-9400-26	26"	80 lbs.	26"	10 Pairs
OI-9400-28	28"	75 lbs.	28"	10 Pairs

MOUNTING SCREWS SOLD SEPARATELY

16 pieces required per pair
SCR-6625FHZ



See page 300 for our complete screw line

ACCESSORIES

REAR MOUNT METAL SOCKET

- Material: Steel
- OI-RMB-S



REAR MOUNT PLASTIC SOCKET

- Material: ABS
- OI-627



SPACER

- Material: ABS
- OI-3616



EURO SLIDES



Superior Quality

PART #	SIZE	RECOMMENDED DRAWER WIDTH
OI-1500-10	10"	10"
OI-1500-12	12"	12"
OI-1500-14	14"	14"
OI-1500-16	16"	16"
OI-1500-18	18"	18"
OI-1500-20	20"	20"
OI-1500-22	22"	22"
OI-1500-24	24"	24"

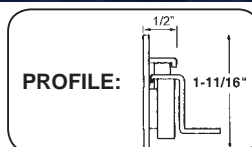

PRODUCT FEATURES:

- Self-close / Stay-closed action
- Load Capacity: 75 lbs.
- 32mm system screw hole pattern
- Durable epoxy coated steel profiles
- Smooth & quiet nylon rollers
- Bottom mounting
- Drawer Extension (Travel): Length of slide minus 1-1/2"
- 1/2" side clearance



ACCESSORIES

REAR MOUNT PLASTIC SOCKET

- Material: ABS
- OI-RMB



REAR MOUNT PLASTIC SOCKET

- Material: ABS
- OI-6402



SPACER

- Material: ABS
- OI-3602



MILLER FASTBLOCK™

- Material: ABS
- FC-MFB-WH
2 pc. pack



- FC-MFB-WH-100
100 pc. pack



STAINLESS STEEL FULL EXTENSION DRAWER SLIDES



OI-3800S SERIES

75 lb. Capacity

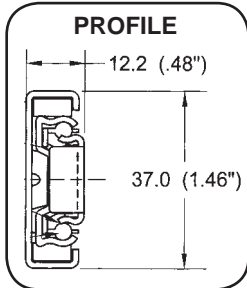
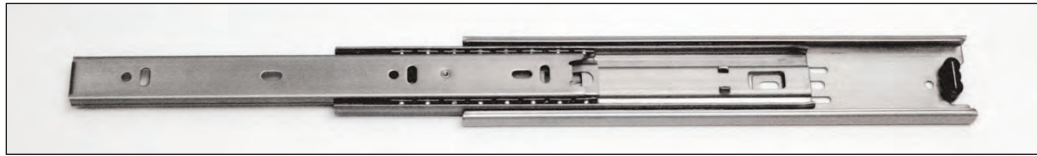

PART #	SLIDE LENGTH	TRAVEL LENGTH	LOAD RATING PER PAIR
OI-3800S-8	7.87"	7.54"	98 lbs.
OI-3800S-10	9.84"	9.57"	92 lbs.
OI-3800S-12	11.81"	12"	88 lbs.
OI-3800S-14	13.78"	14"	84 lbs.
OI-3800S-16	15.75"	16"	79 lbs.
OI-3800S-18	17.72"	18"	75 lbs.
OI-3800S-20	19.69"	20"	73 lbs.
OI-3800S-22	21.65"	22"	68 lbs.
OI-3800S-24	23.62"	24"	64 lbs.

PRODUCT FEATURES:

- 304 grade stainless steel
- 3 member full extension
- Ball bearing construction
- Front disconnect
- Positive stop
- Side mounting
- Non handed
- Screw sold separately

SCREW PART #	BULK CTN. QTY.
SCR-8625PHZ	12,000

#8 x 5/8" Pan Head Zinc

OI-4500S SERIES

100 lb. Capacity

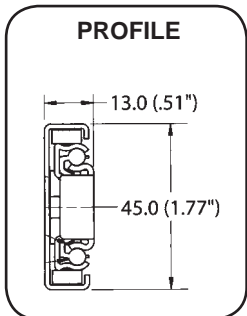
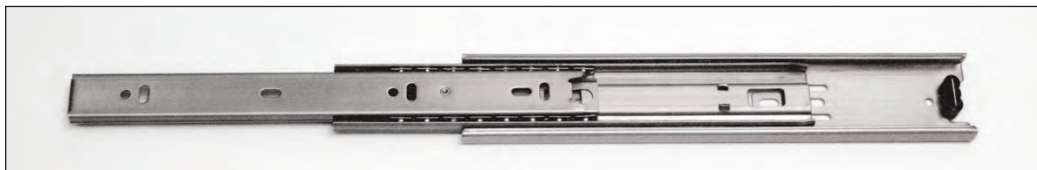

PART #	SLIDE LENGTH	TRAVEL LENGTH	LOAD RATING PER PAIR
OI-4500S-10	9.84"	9.57"	115 lbs.
OI-4500S-12	11.81"	12"	111 lbs.
OI-4500S-14	13.78"	14"	108 lbs.
OI-4500S-16	15.75"	16"	104 lbs.
OI-4500S-18	17.72"	18"	100 lbs.
OI-4500S-20	19.69"	20"	97 lbs.
OI-4500S-22	21.65"	22"	95 lbs.
OI-4500S-24	23.62"	24"	92 lbs.
OI-4500S-26	25.59"	26"	90 lbs.
OI-4500S-28	27.56"	28"	87 lbs.

PRODUCT FEATURES:

- 304 grade stainless steel
- 3 member full extension
- Ball bearing construction
- Front disconnect
- Positive stop
- Side mounting
- Non handed
- Full travel
- Screw sold separately

SCREW PART #	BULK CTN. QTY.
SCR-8625PHZ	12,000

#8 x 5/8" Pan Head Zinc

ACCESSORIES

REAR MOUNT METAL SOCKET

- Material: Steel

OI-RMB-S



REAR MOUNT PLASTIC SOCKET

- Material: ABS

OI-627



SOCKET

- Material: ABS

OI-3616



100 LB. FULL EXTENSION BALL BEARING SLIDE



WITH EASY CLOSE (SOFT CLOSE) MECHANISM

TESTED & CERTIFIED
to ANSI/BIFMA specifications
cycles at 50,000



PART #	LENGTH	LOAD RATING	CARTON SIZE
OI-5000-12	12"	100 lbs.	10 Pairs
OI-5000-14	14"	100 lbs.	10 Pairs
OI-5000-16	16"	100 lbs.	10 Pairs
OI-5000-18	18"	100 lbs.	10 Pairs
OI-5000-20	20"	95 lbs.	10 Pairs
OI-5000-22	22"	90 lbs.	10 Pairs
OI-5000-24	24"	85 lbs.	10 Pairs
OI-5000-26	26"	80 lbs.	10 Pairs
OI-5000-28	28"	75 lbs.	10 Pairs

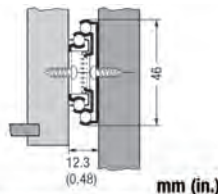

12.3 mm (0.48 in.) is the actual size of the slide.
Allow a min. of 12.7 mm (0.50 in.) for clearance.

PRODUCT FEATURES:

- Lengths: 12" to 28"
- Finish: Clear Zinc
- Precision ball bearing slide for medium-duty applications in office and residential furniture
- Drawer profile features an easy to operate disconnect finger release trigger
- System 32 compatible hole
- Drawer slide is non-handed
- New ECD™ easy close (soft close) device
- 1/2" side clearance

MOUNTING SCREWS SOLD SEPARATELY

16 pieces required per pair
SCR-6625FHZ



See page 300 for our
complete screw line

ACCESSORIES

PENINSULA BRACKETS

- Material: ABS
OI-648



REAR MOUNT PLASTIC SOCKETS

- Material: Steel
OI-5000B-S

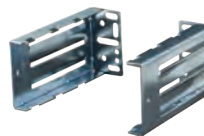

SPACER

- Material: ABS
OI-3616



200 LB. HEAVY DUTY FULL EXTENSION SLIDES



PRODUCT FEATURES:

- Material: Cold Rolled Steel
- Finish: Clear Zinc
- 1" over travel extension
- Easy to operate finger release trigger for drawer removal
- Non-handed
- Hold close detent

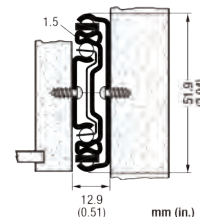
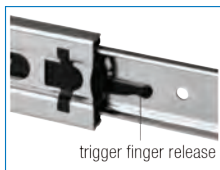

12.9 mm (0.51 in.) is the actual size of the slide.
Allow a min. of 13.1 mm (0.52 in.) for clearance.

PART #	LENGTH	LOAD RATING	CARTON SIZE
OI-5210-14	14"	Dynamic to 200 lbs.	10 Pairs
OI-5210-16	16"	Dynamic to 200 lbs.	10 Pairs
OI-5210-18	18"	Dynamic to 200 lbs.	10 Pairs
OI-5210-20	20"	Dynamic to 200 lbs.	10 Pairs
OI-5210-22	22"	Dynamic to 200 lbs.	10 Pairs
OI-5210-24	24"	Dynamic to 200 lbs.	10 Pairs
OI-5210-26	26"	Dynamic to 200 lbs.	10 Pairs
OI-5210-28	28"	Dynamic to 200 lbs.	10 Pairs

MOUNTING SCREWS SOLD SEPARATELY

16 pieces required per pair
SCR-6625FHZ



See page 300 for our
complete screw line



The "Simple Solution" for Maximizing Storage Space & Convenience

PRODUCT FEATURES:

- Material: ABS
- Can be used with face frame or frameless cabinets
- Installs easily with a screw driver & adjusts without tools

Hook Dowels are Included In All Kits



Unique hook dowels allows you to work with most full extension european & undermount drawer slides. Hooks get connect to drawer slides.

Standard Supports (All Inclusive Kits)

Includes 4 supports, 4 Hook Dowels (Full Extension/European) & Mounting Screws



1" Wide Quik Tray Support

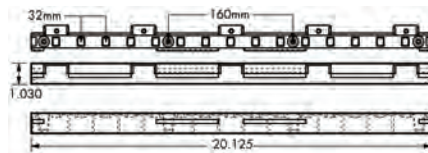

PART #	THICKNESS	LENGTH	COLOR	SETS PER CARTON
QT10-*	1" W / .250" Standoff	20.125"	*WH - White / *CR - Cream	25



1-1/4" Wide Quik Tray Support

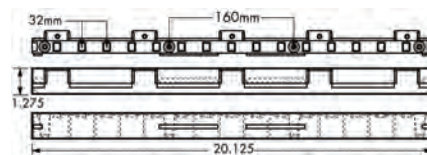

PART #	THICKNESS	LENGTH	COLOR	SETS PER CARTON
QT14-*	1-1/4" W / .325" Standoff	20.125"	*WH - White / *CR - Cream	25



2" Wide Quik Tray Support

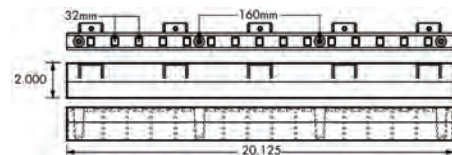

PART #	THICKNESS	LENGTH	COLOR	SETS PER CARTON
QT20-*	2" Without Standoff	20.125"	*WH - White *CR - Cream	12



1-1/4" Wide Short Support Sets (All Inclusive Kit)

Includes 4 Supports, 4 Hook Dowels (Full Extension/European) & Mounting Screws

Only Works With QT-14-*

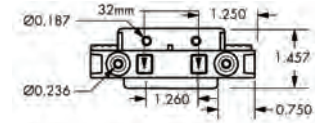

PART #	THICKNESS	LENGTH	COLOR	SETS PER CARTON
QT14S-*	1-1/4" W / .325" Standoff	3-3/4"	*WH - White / *CR - Cream	25

Center Partition Support Set (All Inclusive Kit)

Includes 2 Partition Supports & Mounting Screws



Ideal For Double Door Application Without A Face Frames

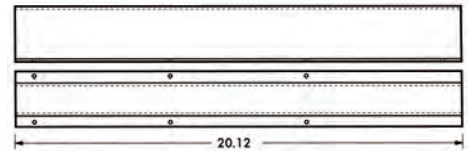

PART #	LENGTH	COLOR	SETS PER CARTON
QTP-*	20.12"	*WH - White / *CR - Cream	12

Quik Tray Mounting Hardware



Hook dowel for undermount drawer slides

Set of 8 & Screws

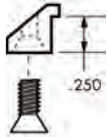

PART #	SETS PER CARTON
QTHK-U	50

11.5MM Tray Bumper Beige:
2 Bumpers & 2 Screws Per Set

See Page 309

18MM Tray Bumper Beige- 2

See Page 309

No Need To Change Existing Cabinets



Face Frame with Low Profile Hinge



Frameless Cabinet with Concealed Hinge



2" Support with Long Arm Hinge & Face Frame Cabinet

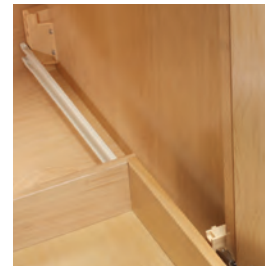

Short Supports for Low Profile Cabinets



Quik Tray supports can be mounted to center partition supports instead of wood stile



HEAVY DUTY PROGRESSIVE ACTION FULL EXTENSION CABINET SLIDES

(FROM 200-475 LBS. OF DYNAMIC LOAD BEARING CAPACITY)

TOP AND BOTTOM SLIDE WITH SOFT CLOSE MECHANISM

Ideally suited for tall kitchen pantries, vertical cabinet pull-outs at any height or width, heavy duty pull-out space saving applications, special projects or other architecturally engineered projects where smooth running and heavy use is critical

PRODUCT FEATURES:

- Material: White Powder Coated Cold Rolled Steel
- Floor mounted with top slide for lateral stability
- The delrin encased steel ball bearings provides a quiet and optimum movement
- Vertical and horizontal adjustment capabilities allows for alignment after install is complete
- ECD - integrated easy (or soft) close device
- No deflection when extended
- Double sided captive profile (**775 ONLY**)
- Extension is length of slide less approximately 3/4"
- No Lubrication Required!

Note: Lubrication must not be applied to any part of the slide as this will prevent the product from working properly

FEATURES	OI-775	OI-771
LOAD RATING	175 LBS	275 LBS
MAXIMUM CABINET HEIGHT	59"	-
BRAKE (OR STOP)	No	Yes

OI-775

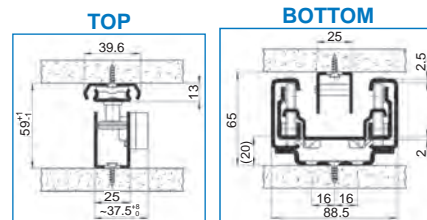
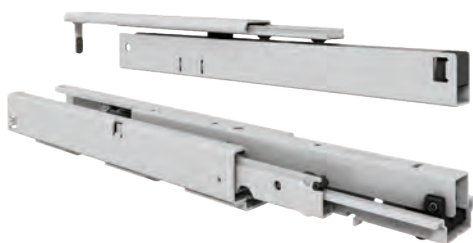

PART #	SLIDE LENGTH (NOMINAL)	ACTUAL LENGTH	EXTENSION	WEIGHT BY LBS.
OI-775-16	16"	15.75"	15.16"	11 lbs.
OI-775-18	18"	17.72"	17.13"	12 lbs.
OI-775-20	20"	19.69"	19.10"	13.5 lbs.
OI-775-22	22"	21.65"	21.06"	14.5 lbs.
OI-775-24	24"	23.62"	23.03"	16 lbs.
OI-775-26	26"	25.59"	25.00"	17 lbs.
OI-775-28	28"	27.56"	26.97"	18 lbs.
OI-775-30	30"	29.53"	28.94"	20 lbs.

OI-771

TOP RAIL

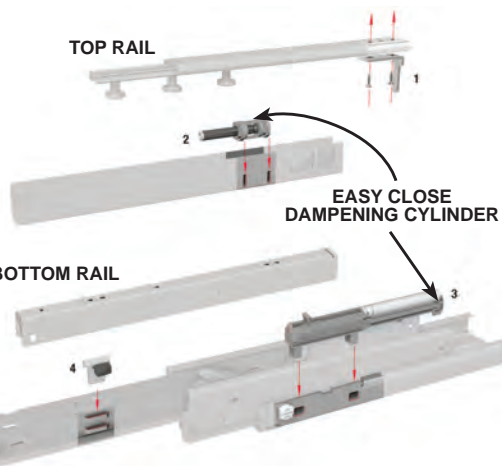

TOP

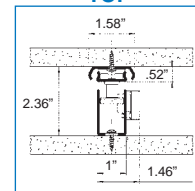

BOTTOM

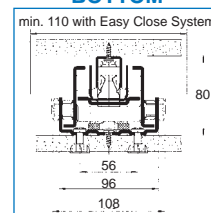

PART #	SLIDE LENGTH (NOMINAL)	ACTUAL LENGTH	EXTENSION	WEIGHT BY LBS.
OI-771-22	22"	22.64"	22.01"	19.50 lbs.





HEAVY DUTY PROGRESSIVE ACTION FULL EXTENSION CABINET SLIDES



**(FROM 200-475 LBS. OF DYNAMIC LOAD BEARING CAPACITY)
TOP AND BOTTOM SLIDE WITH SOFT CLOSE MECHANISM**

Ideally suited for tall kitchen pantries, vertical cabinet pull-outs at any height or width, heavy duty pull-out space saving applications, special projects or other architecturally engineered projects where smooth running and heavy use is critical

FEATURES	OI-777
LOAD RATING	450 LBS
MAXIMUM CABINET HEIGHT	-
BRAKE (OR STOP)	Yes

PRODUCT FEATURES:

- Material: White Powder Coated Cold Rolled Steel
- Floor mounted with top slide for lateral stability
- The delrin encased steel ball bearings provides a quiet and optimum movement
- Vertical and horizontal adjustment capabilities allows for alignment after install is complete
- ECD - integrated easy (or soft) close device
- No deflection when extended
- Double sided captive profile (**775 ONLY**)
- Extension is length of slide less approximately 3/4"
- No Lubrication Required!

Note: Lubrication must not be applied to any part of the slide as this will prevent the product from working properly

OI-777

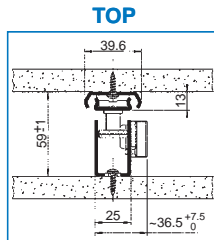
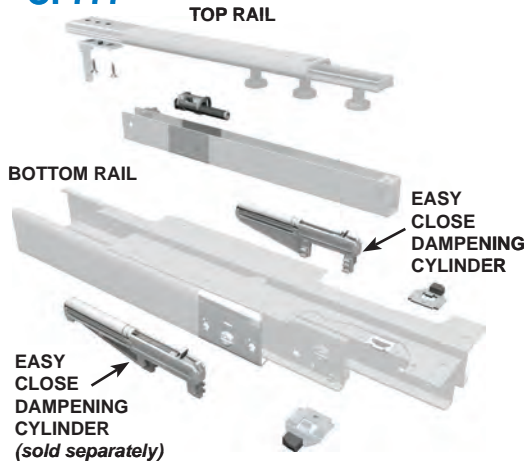

BOTTOM

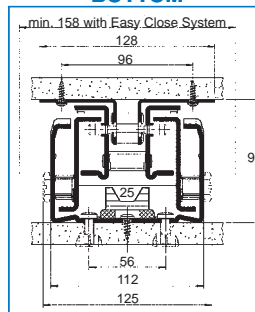

PART #	SLIDE LENGTH (NOMINAL)	ACTUAL LENGTH	EXTENSION	WEIGHT BY LBS.
OI-777-16	16"	15.74"	15.12"	20.50 lbs.
OI-777-18	18"	17.72"	17.09"	23 lbs.
OI-777-20	20"	19.69"	19.06"	25 lbs.
OI-777-22	22"	21.65"	21.02"	27.50 lbs.
OI-777-24	24"	23.62"	22.99"	30 lbs.
OI-777-26	26"	25.59"	24.96"	32 lbs.
OI-777-28	28"	27.55"	26.93"	34 lbs.
OI-777-30	30"	29.53"	28.9"	36.50 lbs.
OI-777-32	32"	31.50"	30.87"	39 lbs.
OI-777-34	34"	33.47"	32.83"	41.50 lbs.
OI-777-36	36"	35.43"	34.80"	43.50 lbs.
OI-777-EZ	<i>Easy Close System Optional</i>			

HINGES



TEC 864 ONE PIECE HINGE 108° OPENING ANGLE - 1/4" TO 1-1/2" OVERLAY FOR FACE FRAME APPLICATIONS

PRODUCT FEATURES:

- Material: Steel with Zinc Finish
- 1 piece hinge & base plate combination
- Front locating tabs position hinge on face frame

Overall Dimensions

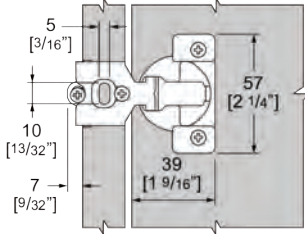

45mm Drill Pattern

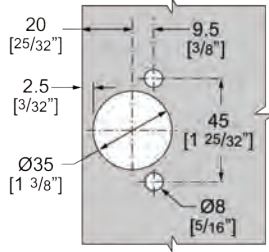

Side Mount Plate



For Smaller or Larger Than Standard 3/4" Face Frames

Wrap Around Plate

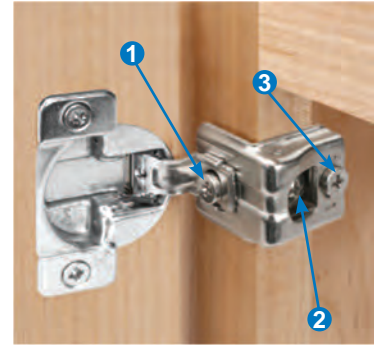

For Standard 3/4" Face Frames
3-Dimensional Adjustment

1. Side Adjustment: +/- 1/16" (1.5mm)
2. Height Adjustment: +/- 3/32" (2mm)
3. Depth Adjustment: + 3/32" (2mm), - 1/16" (1mm)

SIDE MOUNT

PART#	OVERLAY	PLATE TYPE	CARTON QTY.
VS8-108-25S	1/4"	DOWELLED	300
VS8-108-50S	1/2"		300
VS8-108-75S	3/4"		300
VS8-108-100S	1"		300
VS8-108-125S	1-1/4"		300
VS8-108-138S	1-3/8"		300
VS8-108-150S	1-1/2"		300
VS-108-25S	1/4"		SCREW-ON
VS-108-50S	1/2"	300	
VS-108-75S	3/4"	300	
VS-108-100S	1"	300	
VS-108-125S	1-1/4"	300	
VS-108-138S	1-3/8"	300	
VS-108-150S	1-1/2"	300	

WRAP AROUND

PART#	OVERLAY	PLATE TYPE	CARTON QTY.
VS8-108-25W	1/4"	DOWELLED	300
VS8-108-50W	1/2"		300
VS8-108-75W	3/4"		300
VS8-108-100W	1"		300
VS8-108-125W	1-1/4"		300
VS8-108-138W	1-3/8"		300
VS8-108-150W	1-1/2"		300
VS-108-25W	1/4"		SCREW-ON
VS-108-50W	1/2"	300	
VS-108-75W	3/4"	300	
VS-108-125W	1-1/4"	300	
VS-108-138W	1-3/8"	300	
VS-108-150W	1-1/2"	300	

UNI-SOFT CLOSE ADAPTOR



PRODUCT FEATURES:

- Material: Plastic with brushed nickel finish to blend well with hinge finish
- Works for face frame cabinets on all overlays and frameless cabinets on full overlay doors.
- Manually adjustable to desired closing speed.
- Mounts easy in corners with #6 x 3/4" wood screws included.
- 11/16" (17mm) Clearance required.
- Ideal when upgrading existing cabinets or working with other hinges options.

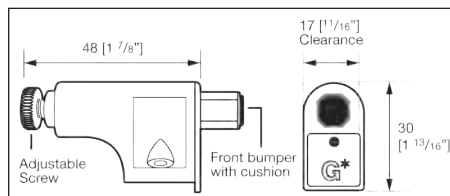

PART#	DESCRIPTION
UNI-SFT	Individual Polybag
UNI-SFT-25	25 piece bag



HINGES



TEC ONE PIECE SOFT CLOSE HINGE 108° OPENING ANGLE - 1/4" TO 1" OVERLAY FOR FACE FRAME APPLICATIONS



PRODUCT FEATURES:

- Material: Steel with Zinc Finish
- Soft close damper premounted in hinge cup
- 1 piece hinge & base plate combination
- Front locating tabs position hinge on face frame

Overall Dimensions

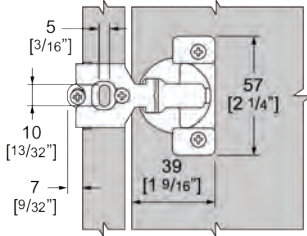

45mm Drill Pattern

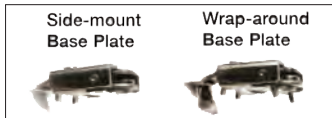
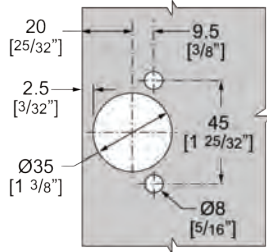

SIDE MOUNT

PART#	OVERLAY	PLATE TYPE
VS8-45U-25S	1/4"	DOWELLED

Side Mount Plate



For Smaller or Larger Than Standard 3/4" Face Frames

Wrap Around Plate

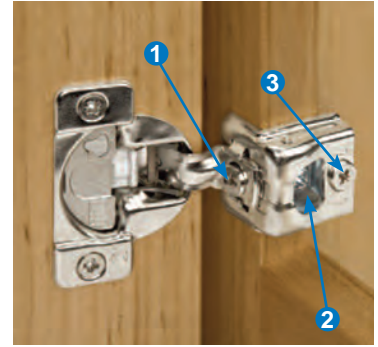

For Standard 3/4" Face Frames
3-Dimensional Adjustment

1. Side Adjustment: +/- 1/16" (1.5mm)
2. Height Adjustment: +/- 3/32" (2mm)
3. Depth Adjustment: + 3/32" (2mm), - 1/32" (.5mm)

WRAP AROUND

PART#	OVERLAY	PLATE TYPE
VS8-45U-25W	1/4"	DOWELLED
VS8-45U-50W	1/2"	
VS8-45U-75W	3/4"	
VS8-45U-100W	1"	SCREW-ON
VS-45U-25W	1/4"	
VS-45U-50W	1/2"	
VS-45U-75W	3/4"	
VS-45U-100W	1"	

Technical Information

There are numerous variables that will determine the choice of hinge. Determine the requirements of the application. Consider the following points based on the door to cabinet application.

1. Door overlay
2. Adjustment requirements:
 - a. Height only
 - b. Height and side
 - c. Height, side and depth
3. Base plate mounting to face frame:
 - a. Wrap-around - 3/4" thick frames only
 - b. Side mount - frames thicker than 3/4"
 - c. Face mount - any overlay greater than 1-3/8"
 - d. MDF material - mounting into end grain
4. Door removal:
 - a. With base plate mounting screw (one-piece hinges)
 - b. With depth adjustment screw (two-piece hinges)
5. Door clearance/hinge arm clearance (for interior rollout trays)
6. Door gap-distance between face frame and the back of the closed door
7. Minimum reveal - distance between two doors hinged back-to-back
8. Door thickness - thicker doors can restrict opening angle and minimum reveal
9. Hinge cup boring pattern for dowelled hinges
10. Door opening angle

Number of hinges per door

The number of hinges required on the size and weight of the door. The distance between the hinges should be spaced as wide as possible. Use the diagram to determine the number of hinges needed. These recommendations are for doors without any accessory attachments.

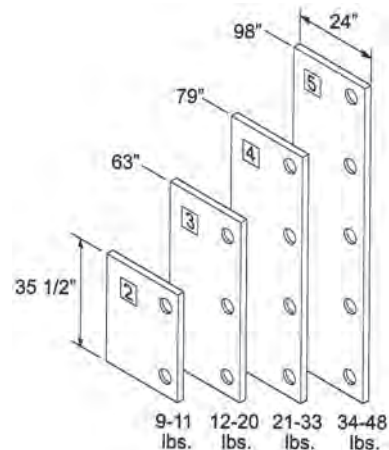

HINGES



NEXIS CLICK-ON QUICK MOUNTING HINGES

PRODUCT FEATURES:

- All Metal, Nickel Plated, self closing hinges.
- Full overlay, half overlay, and in-set options.
- Screw-on or doweled (knock-in) options available.
- All hinges work with **soft close system** - see individual charts below.
- Plate options available for Face Frame or Frameless applications.

Door Size Guidelines

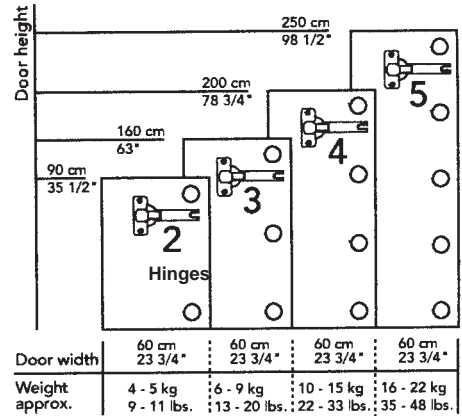

100° OPENING

SPECIFICATIONS:

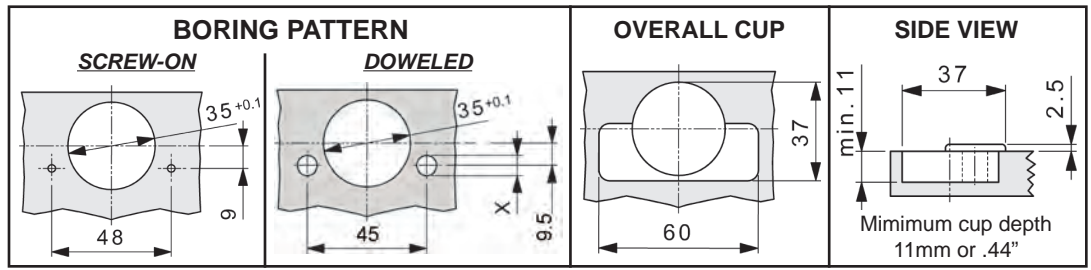

• Works with up to 7/8" (22mm) thick door.

SCREW-ON

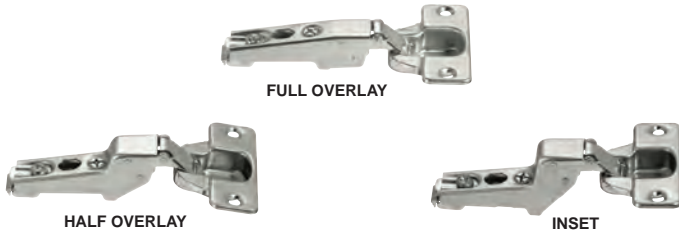

PART#	DESCRIPTION	PCS. PER CARTON
CS4-100S-F	Full Overlay (00)	250
CS4-100S-H	Half Overlay (08)	250
CS4-100S-I	Inset (15)	250

PLATES FOR FACE FRAME APPLICATIONS	PLATES FOR FRAMELESS APPLICATIONS	SOFT CLOSE
A, B, C	D, E	See Option A, pg. 329

DOWELED (Knock-In)

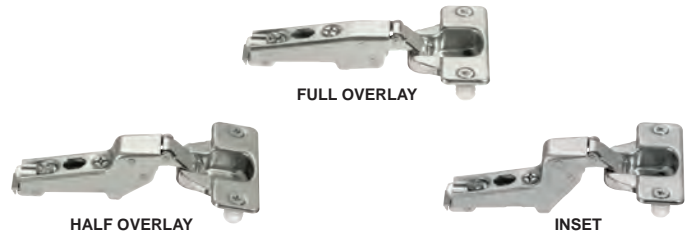

PART#	DESCRIPTION	PCS. PER CARTON
CS4-100D-F	Full Overlay (00)	250
CS4-100D-H	Half Overlay (08)	250
CS4-100D-I	Inset (15)	250

PLATES FOR FACE FRAME APPLICATIONS	PLATES FOR FRAMELESS APPLICATIONS	SOFT CLOSE
A, B, C	D, E	See Option A, pg. 329

* INSTALLATION DIMENSIONS AVAILABLE UPON REQUEST. ALL MEASUREMENTS ARE IN MILLIMETERS.

CS-SCREW

6 x 5/8" Zinc Plated Screw 500 pcs. per carton

HINGES

NEXIS CLICK-ON QUICK MOUNTING HINGES



PRODUCT FEATURES:

- Material: Metal Nickel Plated



BORING PATTERN

SCREW-ON

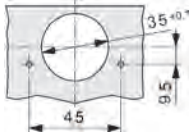

DOWELED

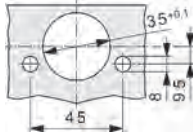

OVERALL CUP

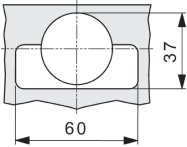

SIDE VIEW

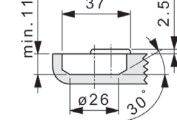

- Minimum cup depth
- 110° - 11mm or .44"
 - 125° - 11.8mm or .47"
 - 170° - 11mm or .44"

SCREW-ON



PART#	DESCRIPTION	DOOR THICKNESS	PCS. PER CARTON
CS22-110S-F	110° Full Overlay (00)	25/32"	250
CS22-110S-H	110° Half Overlay (08)		250
CS04-110S-I	110° Inset (15)		250
CS29-125S-F	125° Full Overlay (00)	3/4"	250
CS29-125S-H	125° Half Overlay (08)		250
CS65-170S-F	170° Full Overlay (00)	1"	250
CS65-170S-H	170° Half Overlay (08)		250

DOWELED (Knock-In)



PART#	DESCRIPTION	DOOR THICKNESS	PCS. PER CARTON
CS22-110D-F	110° Full Overlay (00)	25/32"	250
CS22-110D-H	110° Half Overlay (08)		250
CS04-110D-I	110° Inset (15)		250
CS29-125D-F	125° Full Overlay (00)	3/4"	250
CS29-125D-H	125° Half Overlay (08)		250
CS65-170D-F	170° Full Overlay (00)	1"	250
CS65-170D-H	170° Half Overlay (08)		250

PLATES FOR FACE FRAME APPLICATIONS	PLATES FOR FRAMELESS APPLICATIONS	SOFT CLOSE
A, B, C	D, E	See Option A, pg. 329 (For 100°, 110° & 125° Only)

NEXIS IMPRESSO WITH "TOOL-LESS" QUICK MOUNTING TECHNOLOGY

PRODUCT FEATURES:

- Impresso hinges are perfect for door materials such as Particle Board, Solid Wood and MDF.
- Impresso securely fits and does not allow twisting of the hinge due to a 3-point connection of the hinge cup.
- Material: Metal Nickel Plated

EASY TO INSTALL!

1. Insert Impresso hinges into the door boring.
2. Close the flap of the hinge cup, and you are done!

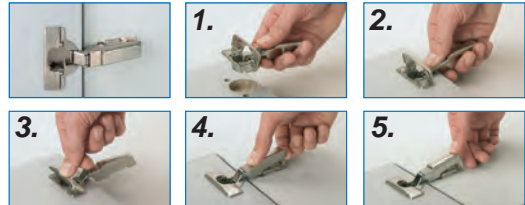

BORING PATTERN

DOWELED

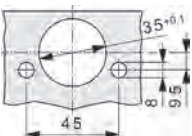

Fits 42mm - 45mm hole patterns

OVERALL CUP

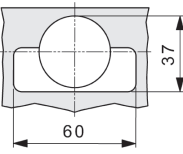

SIDE VIEW

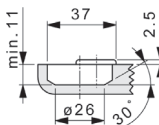

- Minimum cup depth
- 110° - 11.5mm or .46"
 - 125° - 12mm or .48"
 - 170° - 11mm or .44"

DOWELED (Knock-In)



PART#	DESCRIPTION	DOOR THICKNESS	PCS. PER CARTON
CST22-110-F	110° Full Overlay (00)	25/32"	125
CST22-110-H	110° Half Overlay (08)		125
CST29-125-F	125° Full Overlay (00)	3/4"	125
CST29-125-H	125° Half Overlay (08)		125
CST65-170-F	170° Full Overlay (00)	1"	50
CST65-170-H	170° Half Overlay (08)		50

PLATES FOR FACE FRAME APPLICATIONS	PLATES FOR FRAMELESS APPLICATIONS	SOFT CLOSE
A, B, C	D, E	See Option B, pg. 329

*** INSTALLATION DIMENSIONS AVAILABLE UPON REQUEST. ALL MEASUREMENTS ARE IN MILLIMETERS.**
(Screw-on only) CS-SCREW..... 6 x 5/8" Zinc Plated Screw 500 pcs. per carton - No Broken Cartons

NEXIS MOUNTING PLATES



PLEASE REFER TO CHART BELOW WHEN PURCHASING PLATES FOR HINGES DIFFERENT COMBINATIONS WILL YIELD DIFFERENT RESULTS

	HINGES	FULL - 00	HALF - 08	INSET - 15
FRAMELESS PLATES	"00"	Full - 3/4"	Half - 3/4"	Inset
	"02"	Full - 5/8"	Half - 5/8"	Inset
	"08"	Half	Inset	N/A
	"18"	Inset	N/A	N/A
FACE FRAME PLATES	"00"	5/8" - 3/4"	3/8"	N/A
	"04"	1/2"	1/4"	N/A
	"02"	N/A	Inset	N/A

Boring distance will affect overlay result; always prepare a mock up before boring doors.

FOR FACE FRAME APPLICATIONS

- Nickel Plated.
- 6 way adjustment: up and down, in and out, and side to side.
- Height and depth adjustable.
- All adjustments can be made independently.
- **Mounts with wood screws (not included).**

A. SPECIAL PLATE FOR FACE FRAME

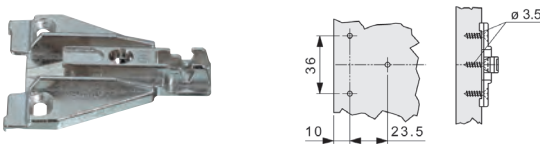

PART#	HINGE TYPE	DOOR OVERLAY	PLATE TYPE	PCS. PER CARTON
CSP-FF88-00	Click-on Twin	1/8" to 3/4"	"00"	250
CSP-FF88-04	Click-on Twin	1/8" to 3/4"	"04"	250

B. 3D CAMPLATE

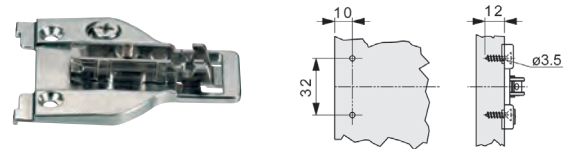

PART#	HINGE TYPE	DOOR OVERLAY	PLATE TYPE	PCS. PER CARTON
CSP-FF91-00	Click-on Twin	1/8" to 3/4"	"00"	250
CSP-FF91-04	Click-on Twin	1/8" to 3/4"	"04"	250

C. BEADED INSET

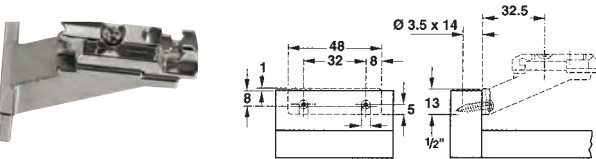

PART#	HINGE TYPE	DOOR OVERLAY	PLATE TYPE	PCS. PER CARTON
CSP-FF90-02	Click-on Twin	Inset	"02"	250

FOR FRAMELESS APPLICATIONS

- Nickel Plated.
- Adjustments can be made independently: up and down.
- Height and depth adjustable.
- **Mounts with wood screws (not included).**

D. SUPER CLICK

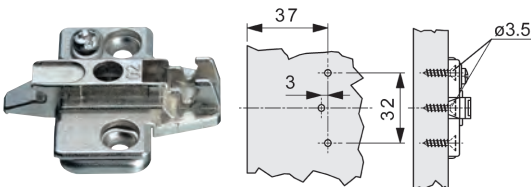

PART#	HINGE TYPE	DOOR OVERLAY	PLATE TYPE	PCS. PER CARTON
CSP-FR55-00	Click-on Twin	Full, Half, Inset	"00"	250
CSP-FR55-08	Click-on Twin	Half, Inset	"08"	250
CSP-FR55-18	Click-on Twin	Inset Only	"18"	250

E. 3D ADJUSTABLE EURO CAM

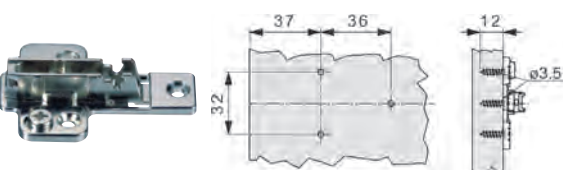

PART#	HINGE TYPE	DOOR OVERLAY	PLATE TYPE	PCS. PER CARTON
CSP-FR70-00	Click-on Twin	Full, Half, Inset	"00"	250
CSP-FR70-08	Click-on Twin	Half, Inset	"08"	250

* INSTALLATION DIMENSIONS AVAILABLE UPON REQUEST. ALL MEASUREMENTS ARE IN MILLIMETERS.

CS-SCREW

6 x 5/8" Zinc Plated Screw 500 pcs. per carton

HINGES

NEXIS SOFT CLOSE SYSTEM



This unique design defines a new closing of doors. The motion of the doors is softly slowed down and the door self closes softly and quietly. • **Toolless.** • **Quick and easy to install.** • **Minimum one set required per two hinges.**

OPTION A: SOFT CLOSE FOR NEXIS HINGES (PART #- CS-*)

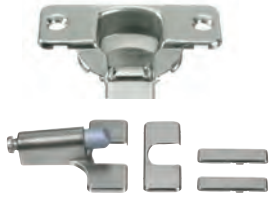

PART# CS-SOFT

NOTE: WORKS WITH 100°, 110° & 125° ONLY

EACH SET INCLUDES:

- 1 Soft Close CS adapter with pre-mounted Soft Close.
- 1 hinge cup cover cap.
- 2 hinge arm cover caps.

CS-SCREW

6 x 5/8" zinc plated screw for "CS" hinges.

OPTION B: SOFT CLOSE FOR IMPRESSO HINGES (PART #- CST-*)



PART# CST-SOFT

EACH SET INCLUDES:

- 1 Soft Close CST adapter.
- 1 Soft Close CST damper.
- 2 hinge arm cover caps.

SPECIALITY HINGES

F 95° OPENING FOR THICK DOORS

Works with doors up to 1-1/8" thick.



PART#	DESCRIPTION	PCS. PER CARTON
CS5-95D-F	Full Overlay (00) Thick Door	250
CS5-95D-H	Half Overlay (08) Thick Door	250
CS5-95D-I	Inset (15) Thick Door	250

DOWELED (Knock-In)

SPECIFICATIONS:

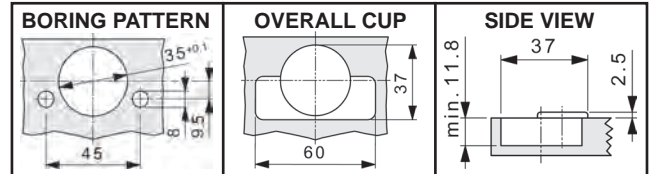

PLATES FOR FACE FRAME APPLICATIONS	PLATES FOR FRAMELESS APPLICATIONS	SOFT CLOSE
A, B, C	D, E	See Option A, above.

CORNER HINGES

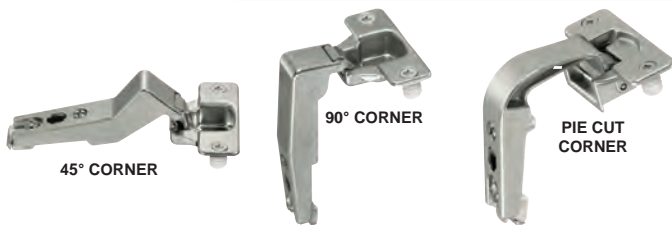

PART#	DESCRIPTION	PCS. PER CARTON
CS5/45-I	45° Corner	125
CS5/90-I	90° Corner	125
CS/D-PCC	Pie Cut Corner	125

PLATES FOR FACE FRAME APPLICATIONS	PLATES FOR FRAMELESS APPLICATIONS	SOFT CLOSE
A, B, C	D, E	See Option A, above.

DOWELED (Knock-In)

SPECIFICATIONS: CS/45-I & CS/90-I

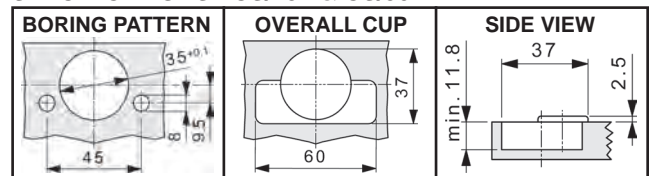

SPECIFICATIONS: CS/D-PCC

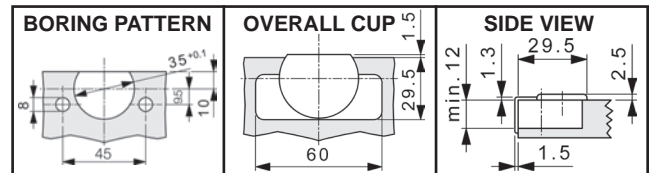

* INSTALLATION DIMENSIONS AVAILABLE UPON REQUEST. ALL MEASUREMENTS ARE IN MILLIMETERS.

CS-SCREW

6 x 5/8" Zinc Plated Screw 500 pcs. per carton

GRASS INSTITUTIONAL HINGES

PRODUCT FEATURES:

- All metal diecast construction for extreme durability in black & nickel finishes.
- Toolless snap-on mounting for quick & easy installation.
- Side-to-Side adjustment of -2mm(1/16") & height adjustment of +/-2mm(1/16").
- Hinge cup has 35mm diameter with a 45/9.5mm boring pattern (similar to Blum).
- Designed for Frameless Cabinet Construction.
- Opening angles range from 180° - 270° depending on your application.
- Meets ANSI/BHMA A 156.9 - 2003 Grade 1 Requirements when the screw & adjustment tabs are in place.
- Cover caps (included) conceal mounting screws.
- One hinge cup works arms.



	TYPE	PART #	
		BLACK	NICKEL
HINGE CUP	SCREW-ON	MBS-8010-BK	MBS-8010-N
	DOWELLED	MBD-8010-BK	MBD-8010-N
FULL OVERLAY HINGE ARM	270°	MB-8310-BK	MB-8310-N
HALF OVERLAY HINGE ARM	230°	MB-8510-BK	MB-8510-N
COMMON PANEL (INSET) HINGE ARM	180°	MB-8610-BK	MB-8610-N
EURO-SCREWS FOR HINGE ARM	N/A	MB-SCREW [^] #6 x 13.5mm Euro Screw	

[^] 2 SCREWS REQUIRED FOR HINGE ARM MOUNTING

1/2" OVERLAY INSTITUTIONAL HINGE

Material: Steel

44 lb. Load Rating



- 2-3/4" Five Knuckle Hinge.
- Designed for 32mm hole system.
- Radius ground hospital tips.
- Matte Chrome finish.

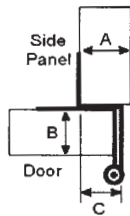

PART#	DIMENSIONS		
	A	B	C
INSHIN-34	3/4"	3/4"	23/32"

32mm OVERLAY INSTITUTIONAL HINGE

Gloss White, Gloss Black, Dull Chrome

Material: Steel

Made in USA.

- 2 3/4" Five Knuckle Hinge.
- Radius Ground Hospital Tips For Increased Safety.
- Designed for 32mm Hole System.
- Radius Corners For Easy Mortising
- ANSI/BHMA A156.9 Grade 1.

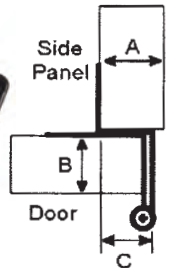

PART#	DIMENSIONS		
	A	B	C
IH-E60-	3/4"	3/4"	23/32"
IH-G60-	3/4"	13/16"	23/32"

FLAP DOOR HINGE



Material: Steel



- Opening angle 90°.
- For flap door thickness up to 20mm.
- Cup boring cover.
- Bottom and Flap door are flush inside the cabinet when doors are open.
- 3-D Adjustable.

PART#	PCS. PER CARTON
	FLAP-735

DOUBLE ACTION SPRING HINGE

Material: Steel

- Allows door to swing back and forth.
- For doors up to 1-1/8" thick.
- Screws & instructions included.
- Dimensions: 4-7/8" high x 3-1/2" wide.



PART#	COLOR
DAH-BRS	Brass
DAH-BLK	Black

NO-BORE GLASS DOOR HINGE

Material: Steel

- For 1/4" Glass.

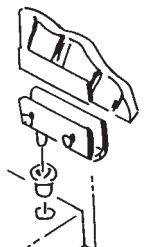

PART #	COLOR
30023-CHR	Chrome

CABINET HINGES & DAMPER

OPI SERIES - SOFT CLOSE PNEUMATIC HINGE



PRODUCT FEATURES:

- **NO MORE SLAMMED DOORS!**
Pneumatic cylinder provides soft closing action.
- **NO EXTRA ACCESSORIES!**
Built-in cylinder makes closing doors easy.
- Clip on system.
- Screws included.



PART#	DESCRIPTION
SFT-HINGE-F	110° Full Overlay Hinge with Plate

CONCEALED METAL HINGE

ONE HINGE DOES IT ALL; FITS ANY FRAME-LESS CABINET.

The CONCEALED METAL HINGE is surface mounted - this means no routing of door or cabinet. Made of cold rolled steel with a bright nickel finish and a stainless steel spring. All pins & rivets are zinc plated for long life.



- Overlay, adjustable from 0 to 3/4".
- 3/8" inset.
- Full inset.
- Allows door to open over 150°.
- Built-in closing mechanism.
- Screws not included.

PART#
SG-225



SOLID BRASS NON-MORTISE CYLINDER HINGE

SOLID BRASS NON-MORTISE CYLINDER HINGE



FOR DOORS OR FLAPS
180 DEGREE

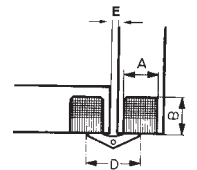

PART #	SIZE	FOR WOOD THICKNESS	A	B	D	E
H-240-10	10mm	1/2"	10	11mm (7/16") Approx.	16.5mm (21/32") Approx.	2.5mm (3/32") Approx.
H-240-12	12mm	5/8"	12	13.5mm (17/32") Approx.	20mm (25/32") Approx.	3.5mm (9/64") Approx.
H-240-14	14mm	3/4"	14	15.5mm (5/8") Approx.	23mm (29/32") Approx.	3mm (1/8") Approx.
H-240-16	16mm	7/8"	16	16.5mm (21/32") Approx.	25mm (1") Approx.	3mm (1/8") Approx.
H-240-18	18mm	1-1/8"	18	17.5mm (11/16") Approx.	27mm (1-1/16") Approx.	3mm (1/8") Approx.

SOFT CLOSE DAMPERS

PRODUCT FEATURES:

- Softens the impact of the door against the cabinet.
- Can be recessed into the cabinet side or mounted to the table.
- Suitable for double doors, inset doors & face frame applications.
- Use 2 dampers for door heights over 3'.

PART#
SFT-MAD-GY

MEDIUM DUTY

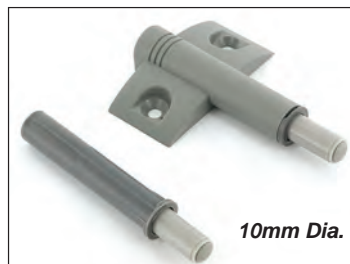

RECESSED

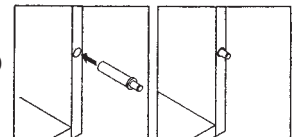

SIDE MOUNTED

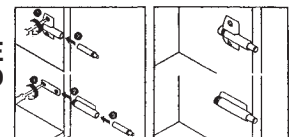

HINGES

TOTALLY CLEAR FLAT HINGES

CLEAR P.E.T.G./PVC with glue groove
5 Ft. Lengths

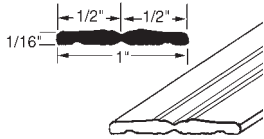

PART #
9888H

CLEAR ACRYLIC/PVC
5 Ft. Lengths

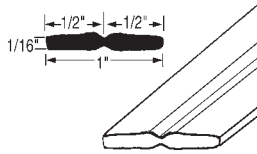

PART #
696H

EXTRUDED HINGE

CLEAR URETHANE & ACRYLIC
4 Ft. Lengths U.V. Stabilized for Outdoor Use!

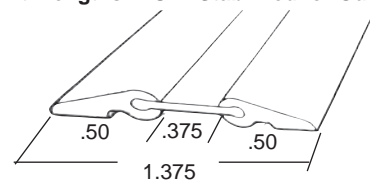

PART #
F2000-CL

PLASTIC PIANO HINGE

Clear or Black
12" Long x 1-3/4" Wide

- Replaces metal hinges that require on to drill, tap or rivet.
- Outer bonding surface is wide for added bonding strength.
- Easily cuts to small size without falling apart.

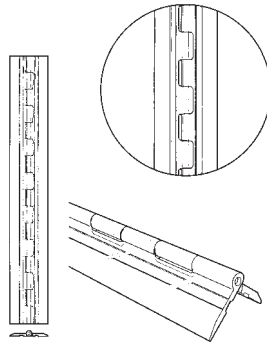

PART #	MATERIAL
PH-175-12CL	Acrylic
PH-175-12BK	ABS

ACRYLIC HASP

Clear, Black or White
2-3/8" Long x 1-1/16" Wide x 1/8" Thick

Bottom section of hasp is reversible for either corner or flat mounting.

Pre-determine assembly before inserting pin completely!

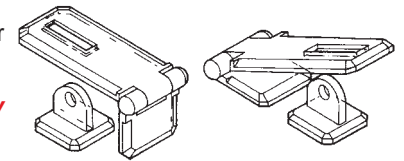

PART #	COLOR
HSP-110-CL	Clear
HSP-110-BK	Black
HSP-110-WH	White

PLASTIC HINGES

CLEAR ACRYLIC HINGE

150-1375

175-150

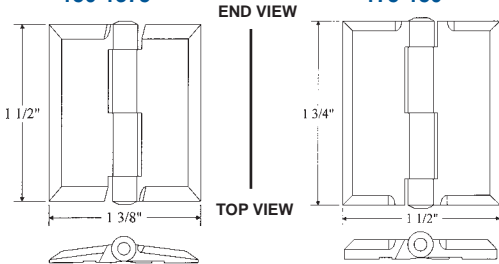

PART #
150-1375
175-150

CLEAR ECONOMY ACRYLIC HINGE

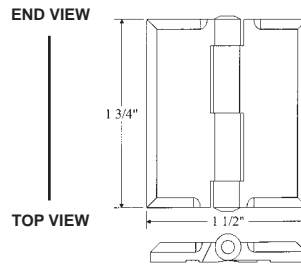

Larger Quantities Available - Please Inquire

PART #
EC175-150

POLYPROPYLENE HINGE

Black or White
Screw Size Recommended
#10 Countersunk (not included)

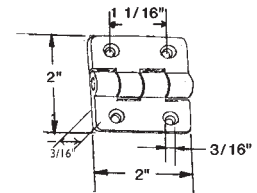

Won't Rust - Quiet - Long Life

PART #	COLOR
200-200-WH	White
200-200-BK	Black

MONSTER HINGE™

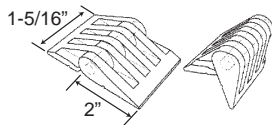

Material: Acrylic DR101 (Clear), ABS (Black)

- New design makes this hinge virtually unbreakable!
- Large ribbed sections added for superior strength!
- Larger pin diameter (.190" dia.)

PART #	DESCRIPTION
MONSTER-HINGE-CL	Clear Acrylic 1-5/16" L x 2" W x 1/2" Thick Hinge
MONSTER-HINGE-BK	Black ABS 1-5/16" L x 2" W x 1/2" Thick Hinge

CONTINUOUS STEEL PIANO HINGE

AVAILABLE FINISHES:

Nickel, Brite Brass, *304 Grade Stainless Steel, Statuary Bronze, Electro Black Lacquered

4 SIZES:

1-1/4" x 72", 1-1/2" x 72", 2" x 72" & 1-1/4" x 100"

1 1-1/4" x .030* x 72"

PART #	FINISH
PH-28-72N	Nickel
PH-28-72B	Brite Brass
PH-28-72BZ	Statuary Bronze
PH-28-72BLQ	Electro Black Lacquered
PH-28-72SS	*304 Grade Stainless Steel

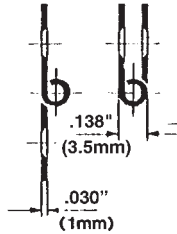

2 1-1/2" x .040* x 72"

PART #	FINISH
PH-40-72N	Nickel
PH-40-72B	Brite Brass
PH-40-72BZ	Statuary Bronze
PH-40-72BLQ	Electro Black Lacquered
PH-40-72SS	*304 Grade Stainless Steel

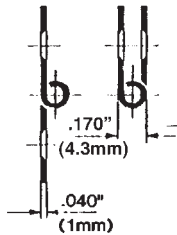

3 2" x .040* x 72"

PART #	FINISH
PH-64-72N	Nickel
PH-64-72B	Brite Brass
PH-64-72BZ	Statuary Bronze
PH-64-72BLQ	Electro Black Lacquered
PH-64-72SS	*304 Grade Stainless Steel

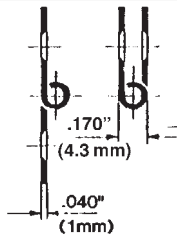

* All Stainless Steel Hinges are .037" Thick

4 100 FT. COILS
1-1/4" x .030" x 100"

PART #	FINISH
PH-28-100N	Nickel
PH-28-100B	Brite Brass

SOLD IN FULL COILS ONLY!

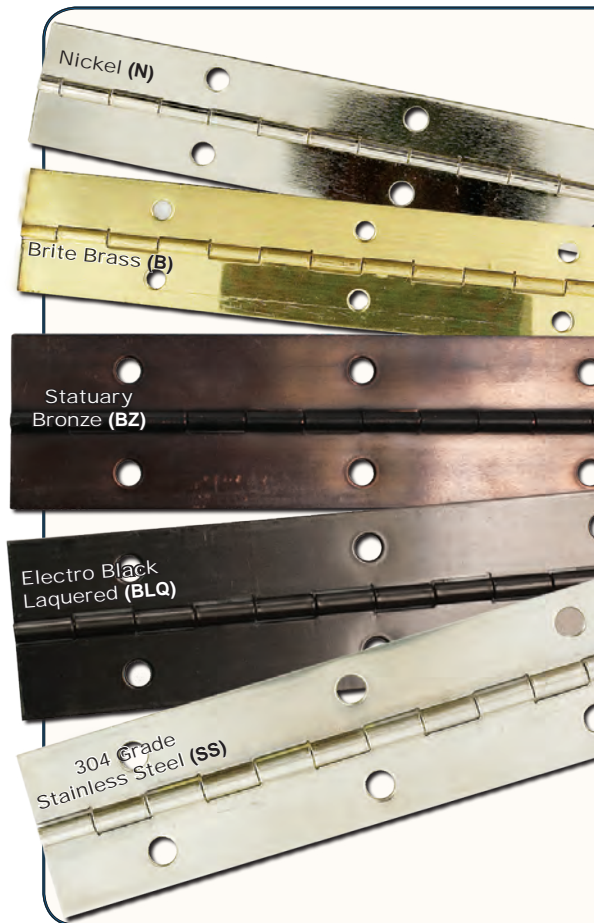
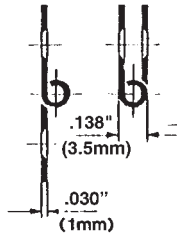

NOTE: All measurements are approximate; please refrain from drilling your holes until product is received.

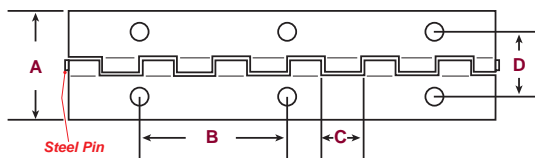

	DIMENSIONS			
	A	B	C	D
1	1-1/4"	2"	1/2"	.750"
2	1-1/2"	2"	1/2"	.876"
3	2"	2"	1/2"	1.13"
4	1-1/4"	2"	1/2"	.75"

If you are interested in aluminum hinges or custom lengths, please inquire.

PIANO HINGE FLAT PHILLIPS SCREWS

PART #	FINISH	WORKS WITH	HEAD SIZE
SCR-5625FHZ	Zinc	all piano hinges	#5 x 5/8"
SCR-5625FHB	Black	except PH-*-72SS	#5 x 5/8"
SCR-6625FHZ	Zinc	only PH-*-72SS (stainless steel hole is larger)	#6 x 5/8"

For Our Complete Line Of Screws See Page 300

72 screws are required per piece.



HG-JHM16/20

PRODUCT FEATURES:

- No more lids that slam shut! This hinge has a built-in soft close dampening mechanism.
- Mortise mounting.
- Sold in pairs, handed.
- Choice of Black or White cover.
- Ideal for small to large lids.
- Calculate torque required to determine which hinge will work best for your application.
- **Torque Calculation:**
Torque = Door Height x 1/2 x Door Weight.
- For upward opening applications only.



HG-JHM16



HG-JHM20

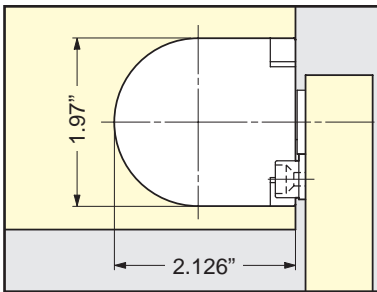

HG-JHM16

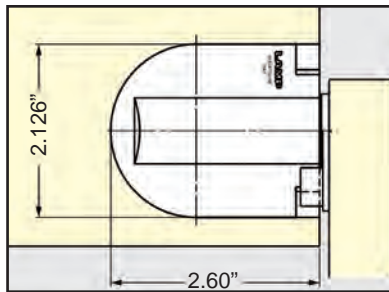

HG-JHM20

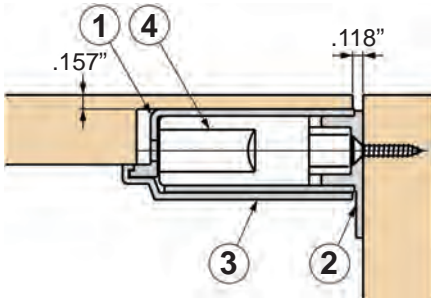
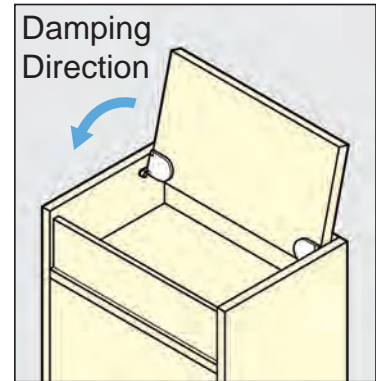

Bracket / Mounting Plate



Black Cover



White Cover

No.	PART NAME	MATERIAL	FINISH / COLOR
1	Bracket	Polyacetal	Black
2	Mounting Plate	Aluminum	Black
3	Face Plate	ABS	Black / White
4	Damper	304 Stainless Steel	Plain

PART #	COLOR	DESCRIPTION	*TORQUE PER PAIR
HG-JHM16-34	Black	Body	17.4 - 29.5 lbs•in
HG-JHM16-50			29.5 - 43.4 lbs•in
HG-JHM16-BL	Black	Face Plate	-
HG-JHM16-WT	White		
HG-JHM20-80	Black	Body	53 - 70.8 lbs•in
HG-JHM20-BL	Black	Cover	-
HG-JHM20-WH	White		

* Torque measurement is referring to pounds of force per inch (lbs•in)

ADJUSTABLE SOFT DOWN STAY



KEEPS FLAP / LIDS FROM SLAMMING SHUT & FLYING OPEN



NO MORE SLAMMING

Torque Calculation: Torque = Door Height x 1/2 x Door Weight
 Per Piece: 20 - 70 kg • cm (19 - 60 lbs • inch)
 Per Pair: 40 - 140 kg • cm (38 - 120 lbs • inch)

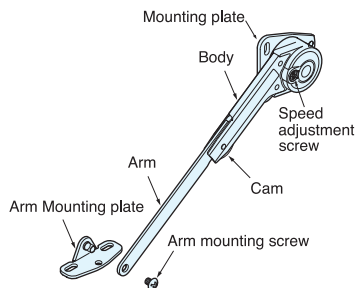

PRODUCT FEATURES:

- Material: Zinc Alloy & Steel
- Finish: Nickel
- For piano / butt / concealed hinges
- Screws included
- Speed adjustment screw for soft close

NSDX-10

90° Opening • For downward opening flap door • Designed to hold door in closed position

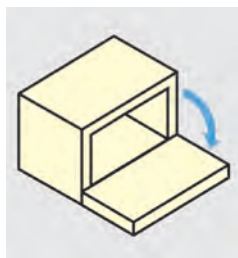

PART #	MOUNTING SIDE	OPENING ANGLE
NSDX-10RK	Right	90°
NSDX-10LK	Left	90°

NSDX-20

70° or 105° Opening • For top opening flap door • Designed to hold door in fully opened position

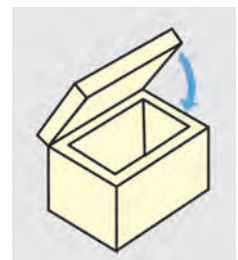

PART #	MOUNTING SIDE	OPENING ANGLE
NSDX-20RK	Right	70° or 105°
NSDX-20LK	Left	70° or 105°

NSDX-35

80°, 90° or 100° Opening • For upward opening flap door • Designed to hold door in fully opened position

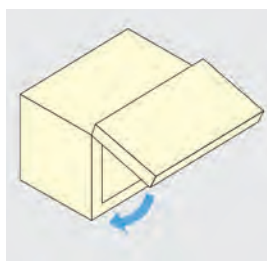
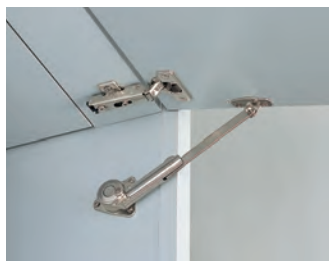

PART #	MOUNTING SIDE	OPENING ANGLE
NSDX-35RK	Right	80°, 90° & 100°
NSDX-35LK	Left	80°, 90° & 100°

Face Frame Bracket



For face frame applications
 use one bracket per arm

PART #
FFCB-SD-1

** All lid stays include the standard mounting plate for wood doors (NSDX-SZ). Mounting plates for aluminum frame (NSDX-AZ) and glass doors (NSDX-GZ) also available. Please Inquire*

SOFT DOWN STAY



SDS-100-TV/TVZ (Short Arm)

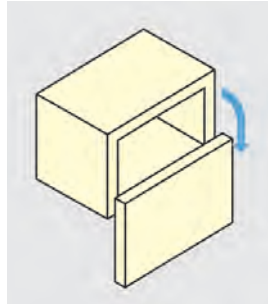

PRODUCT FEATURES:

- Material: Steel and Zinc Alloy with Black or White Plastic Housing
- For DOWNWARD-OPENING FLAP DOOR with piano, butt or drop hinges (SOLD SEPARATELY)
- Designed for small height door application
- SDS-C100TV has a catch to hold the lid closed in position
- SDS-100TV does not have a catch feature and is designed to be used with a magnetic catch or touch latch

Face Frame Bracket



For face frame applications
use one bracket per arm

PART #
FFCB-SD-1

Torque Calculation: Torque = Door Height x 1/2 x Door Weight

PART #	COLOR	TYPE	* TORQUE PER PIECE	* TORQUE PER PAIR
SDS-100W-TV	White	Without	5-12kgf•cm	10-24kgf•cm
SDS-100B-TV	Black	Catch	(4.3-10.4 lbs•in)	(8.7-20.1 lbs•in)
SDS-C100W-TV	White	With	5-12kgf•cm	10-24kgf•cm
SDS-C100B-TV	Black	Catch	(4.3-10.4 lbs•in)	(8.7-20.1 lbs•in)
SDS-100W-TVZ	White	Without	16.5-37.6kgf•cm	33-75.2kgf•cm
SDS-100B-TVZ	Black	Catch	(14.3-32.6 lbs•in)	(28.6-65.2 lbs•in)
SDS-C100W-TVZ	White	With	16.5-37.6kgf•cm	33-75.2kgf•cm
SDS-C100B-TVZ	Black	Catch	(14.3-32.6 lbs•in)	(28.6-65.2 lbs•in)

* Torque measurement is referring to kilograms of force per centimeter (kgf•cm) or pounds of force per inch (lbs•in).

LID STAY



Max 75° Opening

PRODUCT FEATURES:

- Material: 304 Stainless Steel with Satin Finish
- Positive stop to keep flap open
- Left or right hand installation
- 33 lbs. load each
- Screws not included
- Must install parallel to sidewall



PART #
LS-195

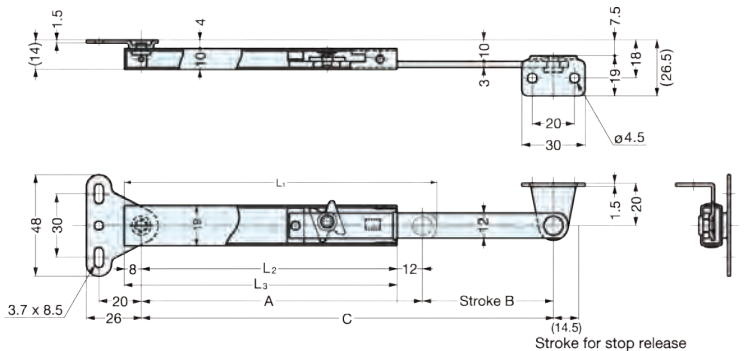

Conversion Formula: mm ÷ 25.40 = inch
Example: 32mm ÷ 25.40 = 1.25 inches

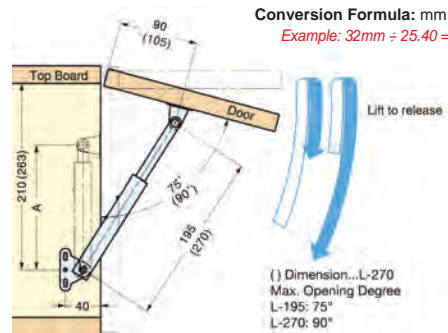



SLS-ELAN



Easy Installation

Only 2 screws needed to secure the body

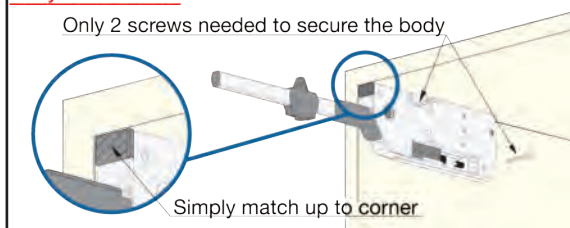

3 functions on 1 stay

1. Lift-assist



2. Free stop



3. Soft-close

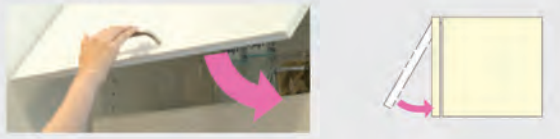

PRODUCT FEATURES:

- LAPCON stay for upward-opening flap doors
- Lift-assist mechanism for extra light-opening
- Damper equipped for soft & silent closing at the end
- Slim design and installed location maximizes space inside of cabinet
- Simply installation by aligning body to edge of cabinet
- Single or pair use allows wide range of door size/weight
- Recognized by LGA for 40,000 cycles

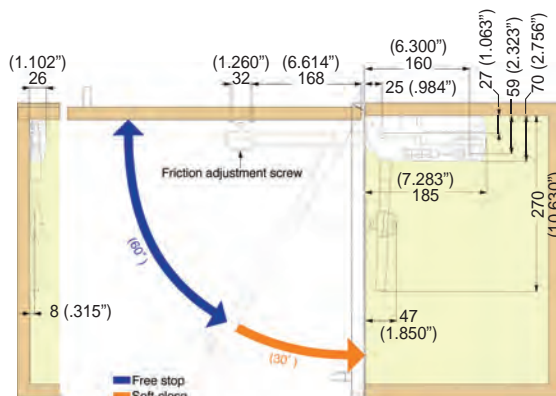

DOOR WEIGHT RANGE TABLE (LBS.)

DOOR HEIGHT (inches)	SINGLE USE				PAIR USE			
	M-TYPE		H-TYPE		M-TYPE		H-TYPE	
	MIN.	MAX.	MIN.	MAX.	MIN.	MAX.	MIN.	MAX.
12"	8.0	10.8	10.8	14.5	16.0	21.7	21.7	29.0
13"	7.4	10.0	10.0	13.4	14.8	20.0	20.0	26.8
14"	6.9	9.3	9.3	12.4	13.7	18.6	18.6	24.9
15"	6.4	8.7	8.7	11.6	12.8	17.3	17.3	23.2
16"	6.0	8.1	8.1	10.9	12.0	16.3	16.3	21.8
17"	5.6	7.6	7.6	10.2	11.3	15.3	15.3	20.5
18"	5.3	7.2	7.2	9.7	10.7	14.4	14.4	19.3
19"	5.1	6.8	6.8	9.2	10.1	13.7	13.7	18.3
20"	4.8	6.5	6.5	8.7	9.6	13.0	13.0	17.4
21"	4.6	6.2	6.2	8.3	9.1	12.4	12.4	16.6
22"	4.4	5.9	5.9	7.9	8.7	11.8	11.8	15.8
23"	4.2	5.7	5.7	7.6	8.3	11.3	11.3	15.1
24"	4.0	5.4	5.4	7.3	8.0	10.8	10.8	14.5
25"	3.8	5.2	5.2	7.0	7.7	10.4	10.4	13.9
26"	3.7	5.0	5.0	6.7	7.4	10.0	10.0	13.4
27"	3.6	4.8	4.8	6.4	7.1	9.6	9.6	12.9
28"	3.4	4.6	4.6	6.2	6.9	9.3	9.3	12.4

Single or Pair use depending on door size

PART #	TYPE	TORQUE PER PIECE	MATERIAL	FINISH/COLOR
SLS-ELAN-MR (Right)	M-Type	55-75 kg-cm	• Aluminum • Steel • ABS	• Anodized • Galvanized • Light Gray
SLS-ELAN-ML (Left)	(Medium Duty)	(48-65 lbs*in)		
SLS-ELAN-HR (Right)	H-Type	75-100 kg-cm		
SLS-ELAN-HL (Left)	(Heavy Duty)	(65-87 lbs*in)		

Face Frame Bracket



For face frame applications use one bracket per arm

PART #

FFCB-SLS

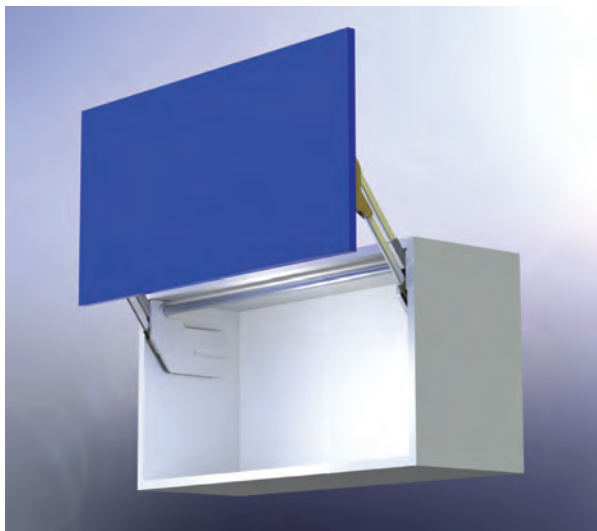

PRODUCT FEATURES:

- Material: Steel, Zinc Alloy, Aluminum & Light Gray ABS
- Lift - assist mechanism for extra light opening
- Free stop so door stays open in any desired position
- Damper equipped for soft and silent closing
- No hinges required
- Only a 6" gap from the face of the cabinet to the back of the door when fully open
- Trimmable connecting bar (sold separately) to fit any width cabinets
- Recommended door sizes and weight: Max Width: 59", Height: 15-3/8" - 19-11/16" & Weight: 11~24.2 lbs./door

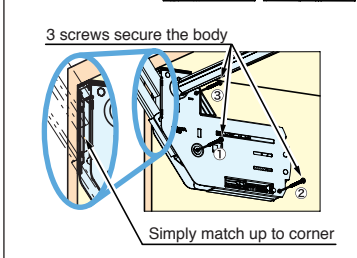
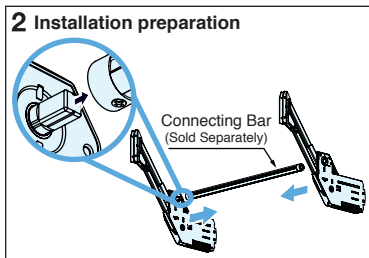
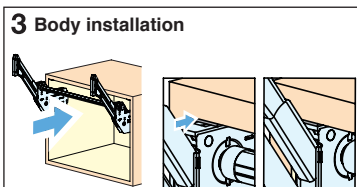
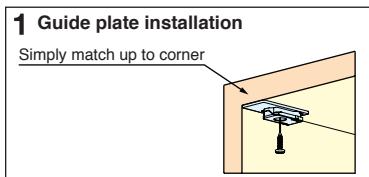
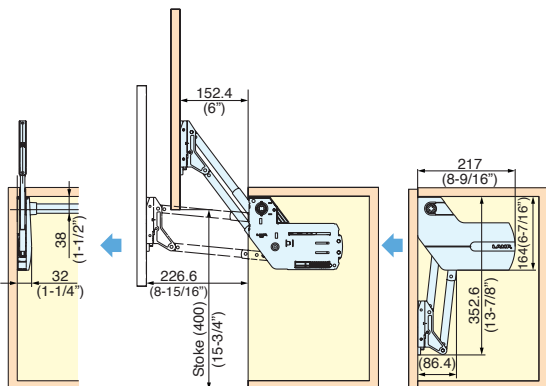

DOOR WEIGHT

PART #	DOOR WEIGHT
SLU-ELAN-S4	11 - 14.3 lbs.
SLU-ELAN-L4	14.3 - 17.6 lbs.
SLU-ELAN-M4	17.6 - 20.9 lbs.
SLU-ELAN-H4	20.9 - 24.2 lbs.

Connecting Bar (Sold Separately)

PART #	CABINET WIDTH
ELB-480	23-5/8"
ELB-780	35-1/2"
ELB-1080	47-1/4"
ELB-1380	59"

Face Frame Bracket

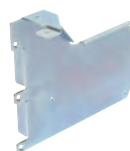

For face frame applications use one bracket per arm

PART #
FFCB-SLU

LATERAL OPENING DOOR HINGE



LATERAL SWING MECHANISM

MonoFlat LIN-X hinge™

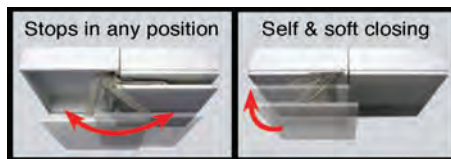

PRODUCT FEATURES:

- Material: Anodized Nickel Finish & Steel/Aluminum
- Ideal for tight front space application
- Allows doors to swing out laterally in a small radius
- Doors will not get in the way when fully opened thus providing full access to the cabinet
- Door has free swing & soft close
- Standard 32mm system mounting
- Can be used in single or double door configuration
- Use with frameless cabinets, optional face frame cabinet bracket available

Easy Access with Full Opening



LIN-X provides maximum access with full opening

Lateral Swing Mechanism

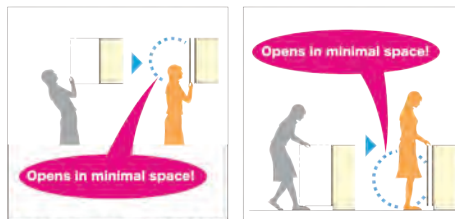

Ideal for tight front space application

PARTS INCLUDED:



- Hinge Body: 2 pcs.
- Mounting Plates: 2 pcs.
- Connecting Bar: 1 pcs.
- Cover Cap: 2 pcs.

EACH BASIC KIT DOES 1 DOOR

CLOSE-UP:



Hinge Body (Closed)

Hinge Body (Open)

Snap-on Installation

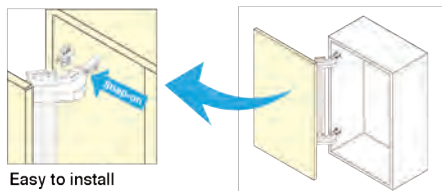

Easy to install

4Way Adjustment

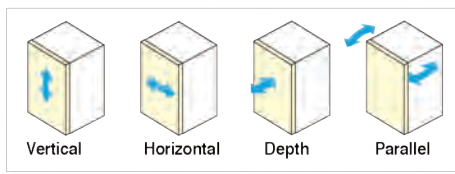

FACE FRAME CABINET OPTIONS

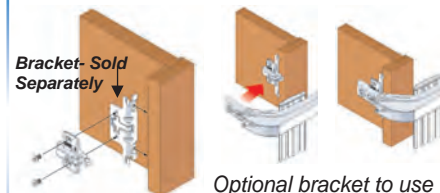

FFCB-HG-1

Optional bracket to use LIN-X450 & LIN-X600 with face frame cabinets.

Can be Opened from Various Points

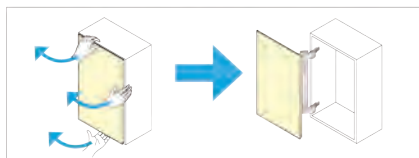

Please note handle position before installation. Handle may interfere with hinge.

Various Applications

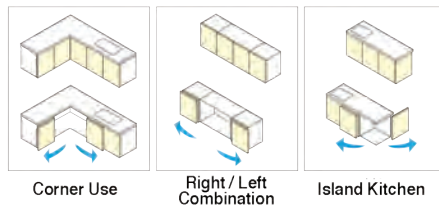

PART #	DOOR WIDTH	DOOR HEIGHT	DOOR THICKNESS	DOOR WEIGHT
LIN-X450	400-500mm 15-3/4" - 19-11/16"	600-900mm 23-5/8" - 35-7/16"	15-24mm 19/32" - 61/64"	max 7kg 15.4 lbs./door
LIN-X600	550-650mm 21-21/32" - 25-19/32"	600-900mm 23-5/8" - 35-7/16"	15-24mm 19/32" - 61/64"	max 9kg 19.8 lbs./door

NOTE: When working with taller/heavier doors, please inquire!!! Many options available!

SWING LIFT MECHANISM



PRODUCT FEATURES:

- Material: Nickel Plated Steel with Gray Plastic Housing
- Screws included
- Adjustable arm mounting plate for various door sizes
- Successfully passed 30,000 open / close private cycle tests
- Patented lapcon technology provides smooth and quiet motion



LIFT UP MECHANISM

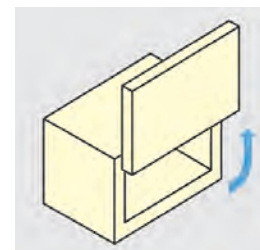

PART #	DOOR WEIGHT	DOOR HEIGHT	DOOR WIDTH
SLUN-3N	6.2 - 8.4 lbs.		
SLUN-4N	8.4 - 10.6 lbs.	15-23/64" - 17-23/32"	23-5/8" - 35-7/16"
SLUN-5N	10.6 - 12.8 lbs.		

SWING DOWN MECHANISM

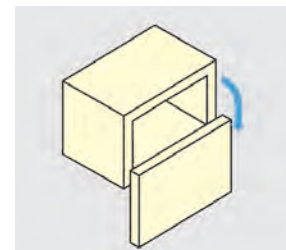

PART #	DOOR WEIGHT	DOOR HEIGHT	DOOR WIDTH
SLD-3	6.6 - 8.8 lbs.		
SLD-4	8.8 - 11.0 lbs.	14-1/8" - 15-3/4"	23-5/8" - 35-7/16"
SLD-5	11.0 - 13.2 lbs.		

BI-FOLD LIFT UP MECHANISM

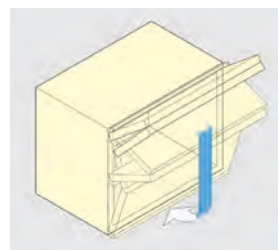

PART #	DOOR WEIGHT	DOOR HEIGHT	DOOR WIDTH
HBFN-2M	5.5 - 7.7 lbs.		
HBFN-3M	7.9 - 9.9 lbs.	12-19/32" - 14-9/16"	17-23/32" - 35-7/16"
HBFN-4M	9.9 - 12.1 lbs.		

OPI ECONOMY SERIES: "LIFT - UP" GAS SPRING

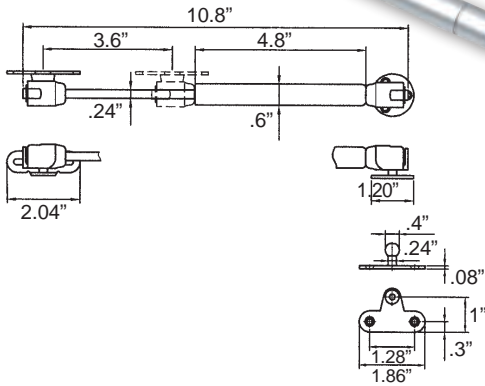
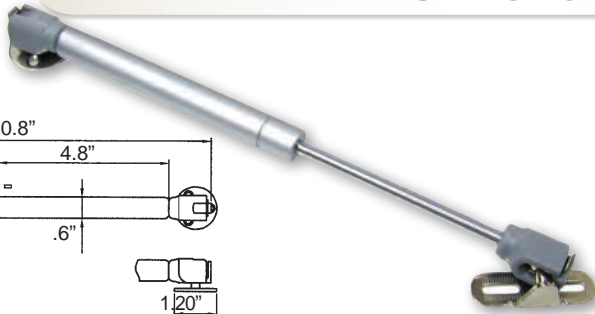

PRODUCT FEATURES:

- Suitable for face frame and frameless applications.
- Suitable for wood and aluminum doors.
- No lubrication required, (**NOTE:** If lubricated, product will not operate properly).
- Set includes: 2 gas springs, 2 sets of mounting brackets and screws.
- Finish: Silver, all metal construction.

PART #	FORCE
LFTUP-100SV	100n (22.5 lbs)
LFTUP-150SV	150n (33.7 lbs)

Gas Springs Selection Guide

Door Weight	2-3 kg (5 - 7 lb)	3.5 - 4.5 kg (8 - 10 lb)	5-6 kg (11 - 13 lb)
Door Height	Force	Force	Force
254 - 305 mm (10 - 12 in)	100 N (22.5 lb)	100 N (22.5 lb)	100 N (22.5 lb)
330 - 380 mm (13 - 15 in)	100 N (22.5 lb)	100 N (22.5 lb)	150 N (33.7 lb)
406 - 457 mm (16 - 18 in)	100 N (22.5 lb)	100 N (22.5 lb)	150 N (33.7 lb)
483 - 533 mm (19 - 21 in)	100 N (22.5 lb)	150 N (33.7 lb)	
559 - 610 mm (22 - 24 in)	100 N (22.5 lb)	150 N (33.7 lb)	

INSTALLATION

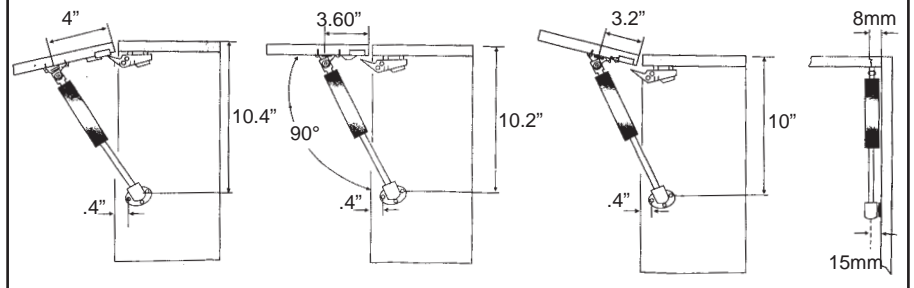

OPI ECONOMY SERIES: SOFT STAYUP HINGE



PRODUCT FEATURES:

This multipurpose stay can be used on "Drop Down" and "Lift up Doors".

- This stay will open as wide as 100°, depending on the adjustment this stay "brakes" the door as it holds in intermediate positions.
- Adjustments can be made using a 4mm allen key.
- 1 piece recommended for doors under 8 lbs. and 2 pieces for doors ranging from 8 lbs. to 16 lbs.
- Non-handed.
- Chrome plated, all metal construction.

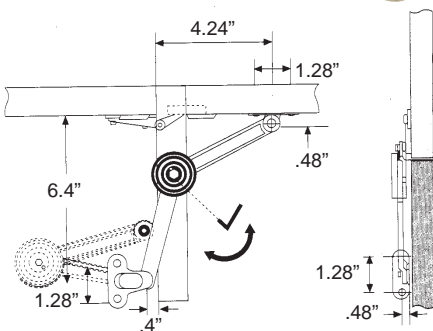

PART #
SSH-2007

CHROME PLATED EURO HINGES



Can be used for either frameless or framed cabinet applications. Opening angle can be adjusted from 45°-90°

PART # **DESCRIPTION**
6552-ETH-10 Euro Hinge
False Front Hinge