

2014



EXHIBIT SYSTEMS

EXHIBIT SYSTEMS

Pgs. 189-218



FOGA®
Exhibit
Systems



klem®
Connecting Systems



Aluminum
Framing
Systems



STANCHIONS



Plastic Landscape w/Stake



Retract-It II (Metal
w/Retractable Belt)

ALUMINUM FRAMING SYSTEMS

| | |
|--|--------------|
| 1" Square Aluminum Tubing | 204 |
| 1" Tubing Connectors & Acc | 205-206, 209 |
| 1-1/2" H.D. Aluminum Tubing | 207 |
| 1-1/2" Tubing Connectors & Accessories | 207 |
| 3/4" Square Aluminum Tubing | 208 |
| 3/4" Tubing Connectors & Accessories | 208 |
| Finger Pulls (Plastic) | 202 |
| Frame Door (Aluminum) | 202 |
| Product Overview | 203 |
| Sliding Door Tracks | 202 |

FOGA® EXHIBIT SYSTEMS

| | |
|---------------------------|---------|
| Corner Couplings | 198 |
| Couplings | 199 |
| Curved Profiles | 196 |
| Display Fittings | 196 |
| End Caps | 197-198 |
| Feet | 197 |
| Foga® Mini | 200 |
| Gear-Edged Profiles | 200 |

FOGA® EXHIBIT SYSTEMS

| | |
|---------------------------------|--------------|
| Glazing Gaskets | 198 |
| Hinges | 197 |
| Locks | 197 |
| Miscellaneous Accessories | 200 |
| Product Overview | 189-192, 201 |
| Profiles | 193-195 |
| Shelf Holders | 197 |
| Shipping Cases | 201 |
| Sliding Door Fittings | 196, 199 |
| Trim Locking Nuts | 198 |

KLEM® CONNECTING SYSTEMS

| | |
|------------------------------------|-----|
| Klem® Connectors Accessories | 211 |
| Mini Klem® Connectors | 211 |
| Product Overview | 210 |
| Super Klem® Connectors | 211 |

STANCHIONS (Crowd Control Products)

| | |
|---------------------------|-----|
| Classic Urn (Metal) | 212 |
| Heavy Duty Plastic | 218 |
| Lighted LED Plastic | 218 |

STANCHIONS (Crowd Control Products)

| | |
|--|---------|
| Plastic Kit (Value 4 Pack) | 217 |
| Plastic Landscape w/Stake | 217 |
| Plastic w/Base | 217 |
| Retract-It II (Metal w/Retractable Belt) | 213 |
| Wood | 214-215 |

STANCHIONS ACCESSORIES

| | |
|---|----------|
| 2 Sided Sign Holder (For Retract-It II) | 213 |
| Plastic Chains | 216 |
| Plastic Clothes Pin | 216 |
| Plastic Connecting Links | 216 |
| Plastic S-Hooks | 216 |
| POP Bowl (For Retract-It II) | 213 |
| Ropes for Stanchions | 212, 214 |
| Signage Adapters | 216 |
| Spring Loaded Connecting Link | 216 |
| Wall Mount Belt (For Retract-It II) | 213 |
| Wall Mount Plate (For Retract-It II) | 213 |
| Wall Plates (For Stanchion Ropes) | 212 |

SEE PAGES 1007-1023 FOR A - Z INDEX



The System with profile since 1965

A quality range of highly versatile modular exhibition display system.

The FOGA® Fastening System offers every conceivable Aluminum Profile, Connector, Hinge and Accessory Component needed to build Exhibits, Displays and Store Fixtures. All components are compatible with one another and are designed for use with industry standard hardware and accessories.



Design Team

A drawing or simple sketch are all we need to take the first step in bringing your project to life. Design assistance and quotations are provided at no charge. We can custom bend profiles to your exact specifications. Let us help you get started on your next project.

Over 100 Profiles



From Which To Choose

So Simple To Build



Connect channels together

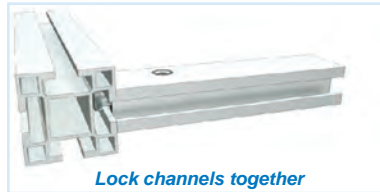

Lock channels together



Tighten connections with a hex key

Low Labor, Quick Setup, No Maintenance

Patented 360° Hinge

Enables you to create many configurations that readily fold in minutes for storage & shipping



Easy To Assemble & Disassemble

... THE POSSIBILITIES ARE ENDLESS!

Partitions

Show Displays

Museums

Show Booths

Display Cases

Kiosks

Signs

For Design Assistance & Technical Information, please call.

...THE POSSIBILITIES ARE ENDLESS!

Signs



PROFILES USED

180A see page 195

91 see page 193



PROFILES USED

180A see page 195

292 see page 194

180A see page 195

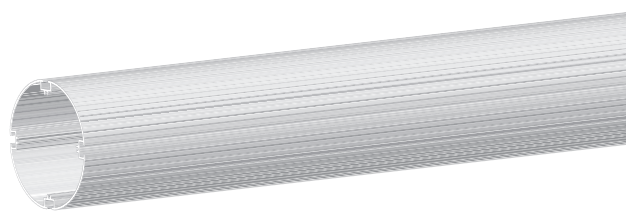
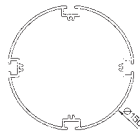

92 see page 193

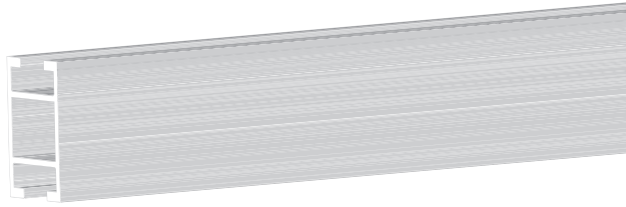
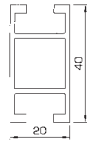

91 see page 193

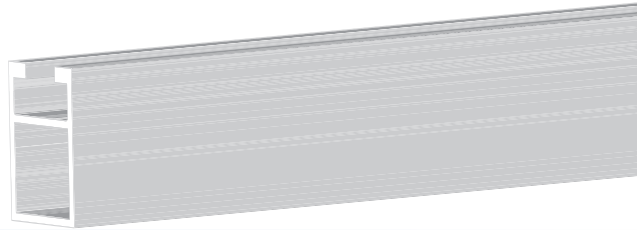
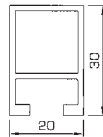

292 see page 194

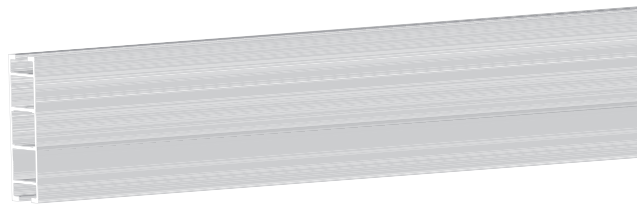

PROFILES USED

180A see page 195

92 see page 193



21-A see page 200

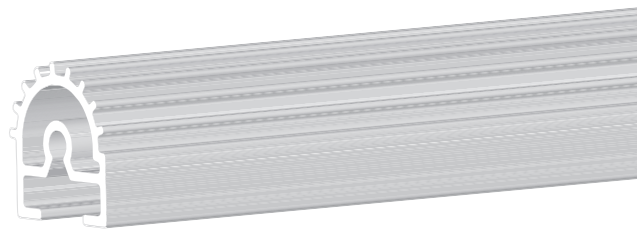
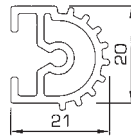

91A see page 200

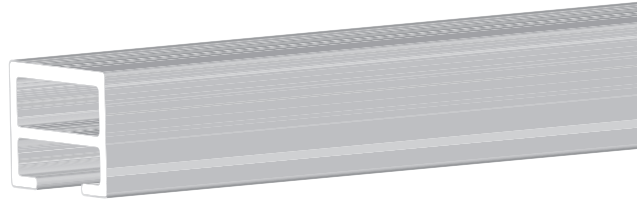
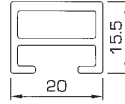

Partitions



Kiosks

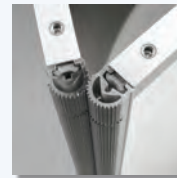

...THE POSSIBILITIES ARE ENDLESS!

Display Cases



94R see page 193

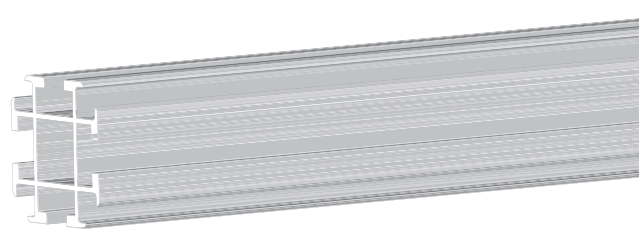
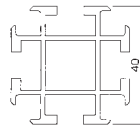

92F see page 193

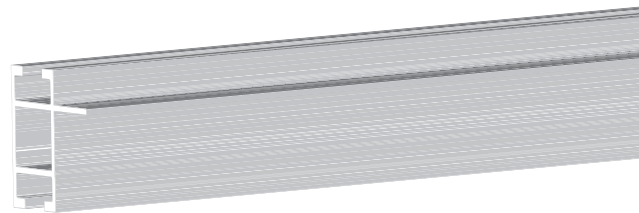

Show Booth



Store Displays



Museums



FOGA® SYSTEMS

CHANNEL SPECS: Channel Widths: 9mm (11/32") Channel Depths: 10mm (3/8")
CONVERSIONS: MM to IN: (MM ÷ 25.4) IN to MM: (IN x 25.4) MTR to FT: (MTR x 3.281) FT to MTR: (FT ÷ 3.281)

FOGA®
SYSTEM
 The System
 with profile
 since 1985

PROFILES

MOST ALUMINUM LENGTHS ARE STOCKED IN (5-MTR OR 16.4') LENGTHS

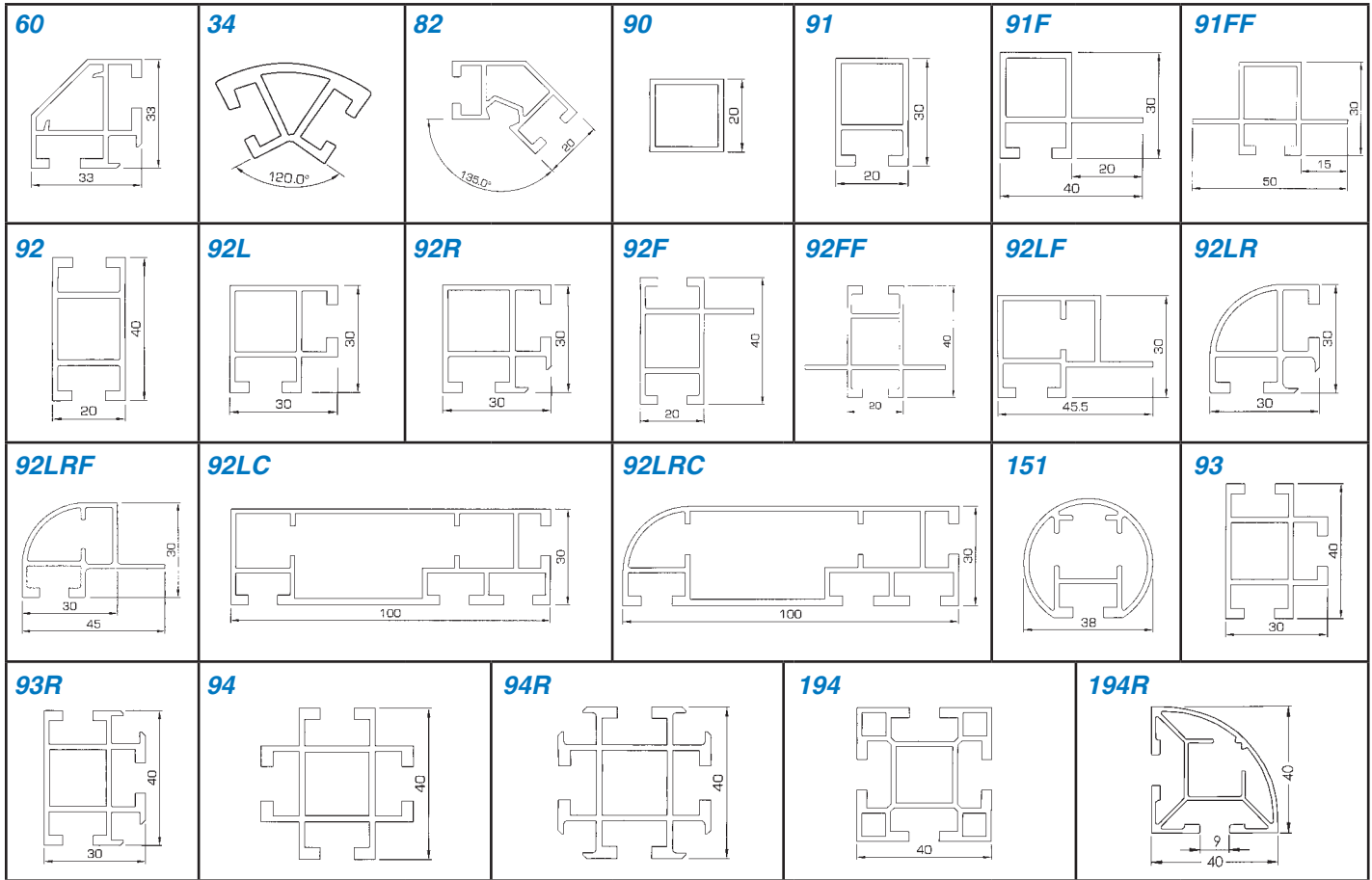

| PART# | DESCRIPTION | ACCESSORIES | | | | | | | |
|-------|--|-------------|------|------|--------|--------|--------|-------|-------|
| 60 | Horizontal or vertical, beveled two-way 90° corner | ■T60 | ▲709 | ◆525 | 950 | ■T953B | ■T953Z | ■T962 | |
| 34 | Corner section 120° | | | | | | | | |
| 82 | 135°, inside shelf support | | | ■T82 | ▲707 | ◆525 | | | |
| 90 | Horizontal or vertical, square tube | ■T90 | ●630 | ▲700 | ▲708 | ▼726 | | | |
| 91 | Horizontal or vertical, one way | ■T91 | ●630 | ▲700 | ▲708 | | | | |
| 91F | Horizontal, one way w/ flange | ■T91 | ●630 | ▲700 | ▲708 | | | | |
| 91FF | Horizontal, one way w/ twin flanges | ■T91 | ●630 | ▲700 | ▲708 | | | | |
| 92 | Horizontal or vertical, two way | ■T92 | ●630 | ▲700 | ▲708 | | | | |
| 92L | Horizontal or vertical, two-way 90° corner | ■T92R | ●630 | ▲700 | ▲708 | 950 | | | |
| 92R | Horizontal or vertical, two-way 90° corner | ■T92R | ●630 | ▲700 | ▲708 | 950 | ■T964 | ■T967 | ■T971 |
| 92F | Horizontal or vertical, two way w/ flange | ■T92 | ●630 | ▲700 | ▲708 | 950 | | | |
| 92FF | Horizontal or vertical, two way w/ twin flange | ■T92 | ●630 | ▲700 | ▲708 | | | | |
| 92LF | Horizontal or vertical, two-way 90° corner w/ flange | ■T92R | ●630 | ▲700 | ▲708 | 950 | ■T964 | ■T967 | ■T971 |
| 92LR | Horizontal or vertical, two-way 90° corner w/shelf support | ■T92LR | ▲707 | ◆525 | 950 | ■T952B | ■T952Z | ■T960 | |
| 92LRF | Horizontal, one way 90° corner w/ flange | ■T92LR | ▲707 | 950 | ■T952B | ■T952Z | ■T960 | | |
| 92LC | Extra wide profile (e.g. for wall mounted showcases) | | | | | | | | |
| 92LRC | Extra wide profile (e.g. for wall mounted showcases) | | | | | | | | |
| 151 | Horizontal or vertical, one way circular profile | | | | | | | | |
| 93 | Horizontal or vertical, Three Way | ■T93 | ●630 | ▲700 | ▲708 | ◆510 | | | |
| 93R | Horizontal or vertical, Three Way w/ shelf support | ■T93 | ●630 | ▲700 | ▲708 | ◆525 | | | |
| 94 | Horizontal or vertical, Four Way | ■T94 | ●630 | ▲700 | ▲708 | ◆510 | | | |
| 94R | Horizontal or vertical, Four Way w/ shelf support | ■T94 | ●630 | ▲700 | ▲708 | ◆525 | | | |
| 194 | Horizontal or vertical, Four Way Square | ■T194 | ●630 | ▲700 | ▲708 | | | | |
| 194R | Horizontal or vertical, two-way 90° corner | ■T194R | ▲700 | ▲708 | | | | | |

■ End Cap ● Ceiling Jack ▲ Adjustable Foot ◆ Shelf Holder ▼ Base Mount Bolt

CHANNEL SPECS: Channel Widths: 9mm (11/32") Channel Depths: 10mm (3/8")
CONVERSIONS: MM to IN: (MM ÷ 25.4) IN to MM: (IN x 25.4) MTR to FT: (MTR x 3.281) FT to MTR: (FT ÷ 3.281)

FOGA®
 The System
 with profile
 since 1985
 SYSTEM

PROFILES

MOST ALUMINUM LENGTHS ARE STOCKED IN (5-MTR OR 16.4') LENGTHS

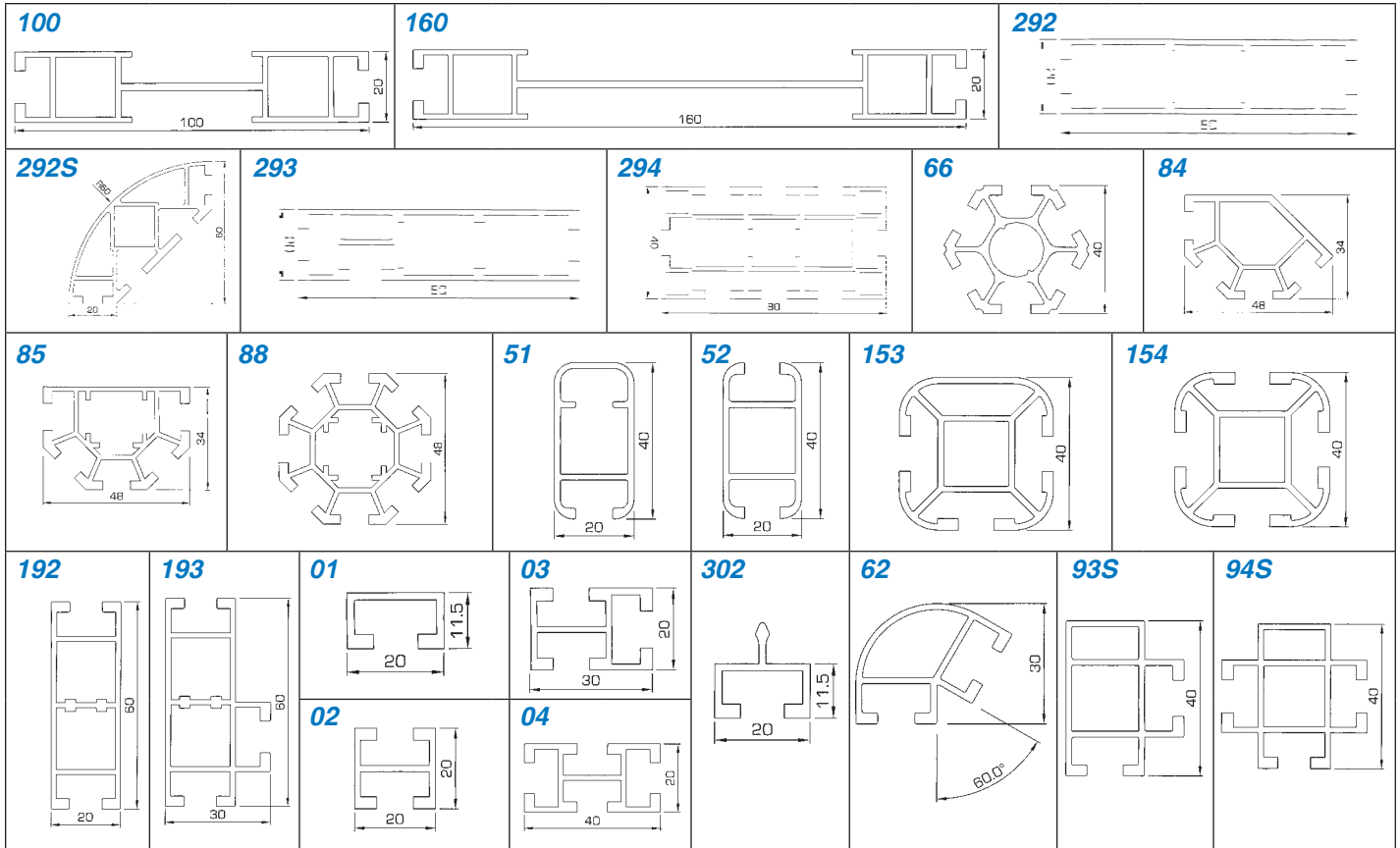

| PART# | DESCRIPTION | ACCESSORIES |
|-------|---|--------------------------|
| 100 | Horizontal or vertical, two way 100mm deep fascia | |
| 160 | Horizontal or vertical, two way 160mm deep fascia | |
| 292 | Horizontal or vertical, two way | ■T92 |
| 292S | Horizontal or vertical, 4 Way Quadrant, large 90° corner | |
| 293 | Horizontal or vertical, 3 Way Side Channel | |
| 294 | Horizontal or vertical, Eight Way for larger structural designs | ■T194 ●630 ▲700 ▲708 |
| 66 | Six Way Pole | ■T66 ●631 ▲705 |
| 84 | 135°, Four Way Pole (section of 88) | |
| 85 | 180°, Five Way Pole (section of 88) | ■T85 ●630 ▲703 |
| 88 | Eight Way Pole | ■T88 ●630 ▲703 |
| 51 | Horizontal or vertical, one way rounded corners | ■T51 ●630 ▲700 ▲708 |
| 52 | Horizontal or vertical, two way rounded corners | ■T51 ●630 ▲700 ▲708 |
| 153 | Horizontal or vertical, three way rounded corners | ■T153 ●630 ▲700 ▲708 |
| 154 | Horizontal or vertical, four way rounded corners | ■T154 ●630 ▲700 ▲708 |
| 192 | Horizontal or vertical, Two Way | |
| 193 | Horizontal or vertical, Three Way | |
| 01 | Horizontal or vertical, single channel | ●610 ●613 |
| 02 | Horizontal or vertical, twin channel | ●610 ●613 |
| 03 | Horizontal or vertical, three way channel | |
| 04 | Horizontal or vertical, four way channel | |
| 302 | Snap fit panel profile 01 (use w/ 313 in-channel clips) | |
| 62 | 60° corner profile | |
| 93S | Profile 93 One Side Closed | ■T93 ●630 ▲700 ▲708 ◆510 |
| 94S | Profile 94 One Side Closed | ■T94 ●630 ▲700 ▲708 ◆510 |



■End Cap ●Ceiling Jack ▲Adjustable Foot ◆Shelf Holder

CHANNEL SPECS: Channel Widths: 9mm (11/32") Channel Depths: 10mm (3/8")

CONVERSIONS: MM to IN: (MM ÷ 25.4) IN to MM: (IN x 25.4) MTR to FT: (MTR x 3.281) FT to MTR: (FT ÷ 3.281)

PROFILES

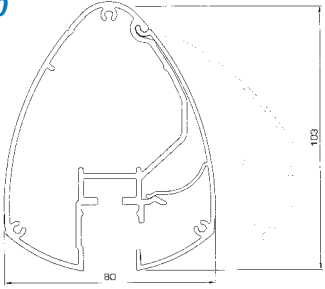
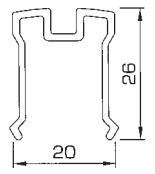
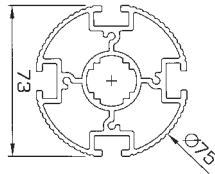
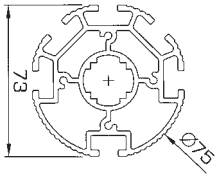
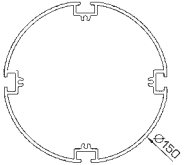
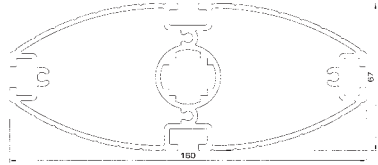
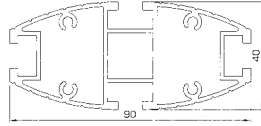
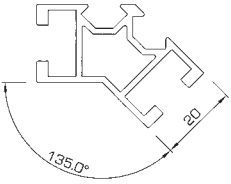
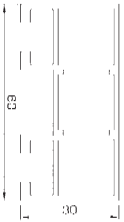
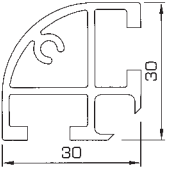
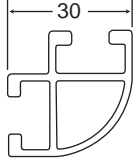
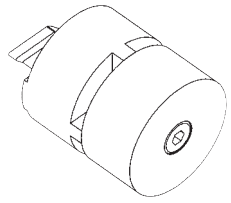
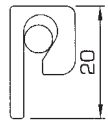
MOST ALUMINUM LENGTHS ARE STOCKED IN (5-MTR OR 16.4') LENGTHS

| <p>S40</p>  | <p>S01</p>  | <p>74</p>  | <p>76</p>  | | | | | | | | | | | | | | | | | | | | | | | | | | | | | | | | | | | |
|--|--|---|--|--|-------|-------------|-----|-----------------------------------|-----|------------------------------------|----|--|----|---|------|--|-----|--|-----|--|------|--|------|---|-------|--|-------|--|-----|--|------|-----------------------------------|-----|---------------------|------|--|------|--|
| <p>180A</p>  | <p>164</p>  | <p>190</p>  | <p>82AE</p>  | | | | | | | | | | | | | | | | | | | | | | | | | | | | | | | | | | | |
| <p>92LL</p>  | <p>92LRS</p>  | <p>92LRV</p>  | <p>650</p>  | <p>S100</p>  | | | | | | | | | | | | | | | | | | | | | | | | | | | | | | | | | | |
| <p>150D</p>  | <p>200D</p>  | <table border="1"> <thead> <tr> <th>PART#</th> <th>DESCRIPTION</th> </tr> </thead> <tbody> <tr> <td>S40</td> <td>Post profile, specially for signs</td> </tr> <tr> <td>S01</td> <td>Aluminum trim for post profile S40</td> </tr> <tr> <td>74</td> <td>Upright, four way, small circular profile w/ ribbed finish</td> </tr> <tr> <td>76</td> <td>Upright, six way, small circular profile w/ ribbed finish</td> </tr> <tr> <td>180A</td> <td>Upright, four way, large circular profile w/ ribbed finish</td> </tr> <tr> <td>164</td> <td>Upright, four way, large elliptical profile w/ ribbed finish</td> </tr> <tr> <td>190</td> <td>Upright, four way, small elliptical profile w/ ribbed finish</td> </tr> <tr> <td>82AE</td> <td>Upright, 135° channel w/ outside shelf support</td> </tr> <tr> <td>92LL</td> <td>Horizontal or vertical, double 90° corner channel</td> </tr> <tr> <td>92LRS</td> <td>Horizontal or vertical, 90° corner w/ shelf support and screw port</td> </tr> <tr> <td>92LRV</td> <td>Horizontal or vertical, 90° corner without R-channel</td> </tr> <tr> <td>650</td> <td>Panel corner clamp, holds graphics independent of your infill panels</td> </tr> <tr> <td>S100</td> <td>Note holder, wall mounted profile</td> </tr> <tr> <td>W90</td> <td>Panel Holder Spring</td> </tr> <tr> <td>150D</td> <td>Horizontal or vertical, flat infill that slides in FOGA channels</td> </tr> <tr> <td>200D</td> <td>Horizontal or vertical, decorative infill that slides in FOGA channels</td> </tr> </tbody> </table> | | | PART# | DESCRIPTION | S40 | Post profile, specially for signs | S01 | Aluminum trim for post profile S40 | 74 | Upright, four way, small circular profile w/ ribbed finish | 76 | Upright, six way, small circular profile w/ ribbed finish | 180A | Upright, four way, large circular profile w/ ribbed finish | 164 | Upright, four way, large elliptical profile w/ ribbed finish | 190 | Upright, four way, small elliptical profile w/ ribbed finish | 82AE | Upright, 135° channel w/ outside shelf support | 92LL | Horizontal or vertical, double 90° corner channel | 92LRS | Horizontal or vertical, 90° corner w/ shelf support and screw port | 92LRV | Horizontal or vertical, 90° corner without R-channel | 650 | Panel corner clamp, holds graphics independent of your infill panels | S100 | Note holder, wall mounted profile | W90 | Panel Holder Spring | 150D | Horizontal or vertical, flat infill that slides in FOGA channels | 200D | Horizontal or vertical, decorative infill that slides in FOGA channels |
| PART# | DESCRIPTION | | | | | | | | | | | | | | | | | | | | | | | | | | | | | | | | | | | | | |
| S40 | Post profile, specially for signs | | | | | | | | | | | | | | | | | | | | | | | | | | | | | | | | | | | | | |
| S01 | Aluminum trim for post profile S40 | | | | | | | | | | | | | | | | | | | | | | | | | | | | | | | | | | | | | |
| 74 | Upright, four way, small circular profile w/ ribbed finish | | | | | | | | | | | | | | | | | | | | | | | | | | | | | | | | | | | | | |
| 76 | Upright, six way, small circular profile w/ ribbed finish | | | | | | | | | | | | | | | | | | | | | | | | | | | | | | | | | | | | | |
| 180A | Upright, four way, large circular profile w/ ribbed finish | | | | | | | | | | | | | | | | | | | | | | | | | | | | | | | | | | | | | |
| 164 | Upright, four way, large elliptical profile w/ ribbed finish | | | | | | | | | | | | | | | | | | | | | | | | | | | | | | | | | | | | | |
| 190 | Upright, four way, small elliptical profile w/ ribbed finish | | | | | | | | | | | | | | | | | | | | | | | | | | | | | | | | | | | | | |
| 82AE | Upright, 135° channel w/ outside shelf support | | | | | | | | | | | | | | | | | | | | | | | | | | | | | | | | | | | | | |
| 92LL | Horizontal or vertical, double 90° corner channel | | | | | | | | | | | | | | | | | | | | | | | | | | | | | | | | | | | | | |
| 92LRS | Horizontal or vertical, 90° corner w/ shelf support and screw port | | | | | | | | | | | | | | | | | | | | | | | | | | | | | | | | | | | | | |
| 92LRV | Horizontal or vertical, 90° corner without R-channel | | | | | | | | | | | | | | | | | | | | | | | | | | | | | | | | | | | | | |
| 650 | Panel corner clamp, holds graphics independent of your infill panels | | | | | | | | | | | | | | | | | | | | | | | | | | | | | | | | | | | | | |
| S100 | Note holder, wall mounted profile | | | | | | | | | | | | | | | | | | | | | | | | | | | | | | | | | | | | | |
| W90 | Panel Holder Spring | | | | | | | | | | | | | | | | | | | | | | | | | | | | | | | | | | | | | |
| 150D | Horizontal or vertical, flat infill that slides in FOGA channels | | | | | | | | | | | | | | | | | | | | | | | | | | | | | | | | | | | | | |
| 200D | Horizontal or vertical, decorative infill that slides in FOGA channels | | | | | | | | | | | | | | | | | | | | | | | | | | | | | | | | | | | | | |

CHANNEL SPECS: Channel Widths: 9mm (11/32") Channel Depths: 10mm (3/8")

CONVERSIONS: MM to IN: (MM ÷ 25.4) IN to MM: (IN x 25.4) MTR to FT: (MTR x 3.281) FT to MTR: (FT ÷ 3.281)

CURVED PROFILES

MOST ALUMINUM LENGTHS ARE STOCKED IN (5-MTR OR 16.4') LENGTHS

| <p>51</p> | <p>52</p> | <p>91</p> | <p>92</p> | | | | | | | | | | | | | | | | | | | | | | | | | | | | | |
|-------------------|---|---|------------------|-------------|------|----------------------------|------|----------------------------|------|---------------------------|------|---------------------------|------|---------------------------|------|----------------------------|------|---------------------------|------|---------------------------|------|----------------------------|------|----------------------------|------|----------------------------|------|----------------------------------|-------|---------------------------|-------|----------------------------|
| <p>292</p> | <p>Quartercircle Segment</p> <p>Any radius is available from 15" & up. All are custom bent in house. Please call for a quotation.</p> <p>Semicircle</p> | <table border="1"> <thead> <tr> <th>PART #</th> <th>DESCRIPTION</th> </tr> </thead> <tbody> <tr> <td>51C2</td> <td>Radius - 1/4 RD - R=1000MM</td> </tr> <tr> <td>52C2</td> <td>Radius - 1/4 RD - R=1000MM</td> </tr> <tr> <td>91C0</td> <td>Radius - 1/4 RD - R=250MM</td> </tr> <tr> <td>91C1</td> <td>Radius - 1/4 RD - R=500MM</td> </tr> <tr> <td>91R1</td> <td>Radius - 1/4 RD - R=600MM</td> </tr> <tr> <td>91C2</td> <td>Radius - 1/4 RD - R=1000MM</td> </tr> <tr> <td>92C0</td> <td>Radius - 1/4 RD - R=250MM</td> </tr> <tr> <td>92C1</td> <td>Radius - 1/4 RD - R=500MM</td> </tr> <tr> <td>92C2</td> <td>Radius - 1/4 RD - R=1000MM</td> </tr> <tr> <td>92C3</td> <td>Radius - 1/4 RD - R=1500MM</td> </tr> <tr> <td>92C4</td> <td>Radius - 1/4 RD - R=2000MM</td> </tr> <tr> <td>92D1</td> <td>Radius Segment 1/2 RD - D=1000MM</td> </tr> <tr> <td>292C1</td> <td>Radius - 1/4 RD - R=500mm</td> </tr> <tr> <td>292C1</td> <td>Radius - 1/4 RD - R=1000mm</td> </tr> </tbody> </table> | PART # | DESCRIPTION | 51C2 | Radius - 1/4 RD - R=1000MM | 52C2 | Radius - 1/4 RD - R=1000MM | 91C0 | Radius - 1/4 RD - R=250MM | 91C1 | Radius - 1/4 RD - R=500MM | 91R1 | Radius - 1/4 RD - R=600MM | 91C2 | Radius - 1/4 RD - R=1000MM | 92C0 | Radius - 1/4 RD - R=250MM | 92C1 | Radius - 1/4 RD - R=500MM | 92C2 | Radius - 1/4 RD - R=1000MM | 92C3 | Radius - 1/4 RD - R=1500MM | 92C4 | Radius - 1/4 RD - R=2000MM | 92D1 | Radius Segment 1/2 RD - D=1000MM | 292C1 | Radius - 1/4 RD - R=500mm | 292C1 | Radius - 1/4 RD - R=1000mm |
| PART # | DESCRIPTION | | | | | | | | | | | | | | | | | | | | | | | | | | | | | | | |
| 51C2 | Radius - 1/4 RD - R=1000MM | | | | | | | | | | | | | | | | | | | | | | | | | | | | | | | |
| 52C2 | Radius - 1/4 RD - R=1000MM | | | | | | | | | | | | | | | | | | | | | | | | | | | | | | | |
| 91C0 | Radius - 1/4 RD - R=250MM | | | | | | | | | | | | | | | | | | | | | | | | | | | | | | | |
| 91C1 | Radius - 1/4 RD - R=500MM | | | | | | | | | | | | | | | | | | | | | | | | | | | | | | | |
| 91R1 | Radius - 1/4 RD - R=600MM | | | | | | | | | | | | | | | | | | | | | | | | | | | | | | | |
| 91C2 | Radius - 1/4 RD - R=1000MM | | | | | | | | | | | | | | | | | | | | | | | | | | | | | | | |
| 92C0 | Radius - 1/4 RD - R=250MM | | | | | | | | | | | | | | | | | | | | | | | | | | | | | | | |
| 92C1 | Radius - 1/4 RD - R=500MM | | | | | | | | | | | | | | | | | | | | | | | | | | | | | | | |
| 92C2 | Radius - 1/4 RD - R=1000MM | | | | | | | | | | | | | | | | | | | | | | | | | | | | | | | |
| 92C3 | Radius - 1/4 RD - R=1500MM | | | | | | | | | | | | | | | | | | | | | | | | | | | | | | | |
| 92C4 | Radius - 1/4 RD - R=2000MM | | | | | | | | | | | | | | | | | | | | | | | | | | | | | | | |
| 92D1 | Radius Segment 1/2 RD - D=1000MM | | | | | | | | | | | | | | | | | | | | | | | | | | | | | | | |
| 292C1 | Radius - 1/4 RD - R=500mm | | | | | | | | | | | | | | | | | | | | | | | | | | | | | | | |
| 292C1 | Radius - 1/4 RD - R=1000mm | | | | | | | | | | | | | | | | | | | | | | | | | | | | | | | |

DISPLAY AND SLIDING DOOR FITTINGS

| <p>105</p> | <p>150</p> | <p>202</p> | <p>301</p> | <p>304</p> | <p>312</p> | | | | | | | | | | | | | | | | | | | | | | | | | | | | | | | | | | | | | | | | | | | | | | | | | | | | | | | | | | | | | | | | | | |
|--------------------|---|-------------------|---|----------------------|----------------------|--------|-------------|-------------|-----|-----------------------|------------|-----|---|--|-----|---|--|-----|--|--|-----|-------------------------------------|--|-----|--|--|-----|---------------------------------|--|-----|--|--|-----|---|--|-----|--|--|--------|--------------------------------------|--|--------|--------------------------------------|--|-----|---------------------------------------|-----------------|-----|--|--|-----|-------------------------|--|-----|---------------------------------------|--|-----|--------------------------------------|--|-----|--------------------------------------|--|------|---|--|-----|-----------------------------------|--|-----|--------|--|
| <p>313</p> | <p>315</p> | <p>318</p> | <p>319</p> | <p>320-20</p> | <p>320-24</p> | | | | | | | | | | | | | | | | | | | | | | | | | | | | | | | | | | | | | | | | | | | | | | | | | | | | | | | | | | | | | | | | | | |
| <p>321</p> | <p>322</p> | <p>323</p> | <table border="1"> <thead> <tr> <th>PART #</th> <th>DESCRIPTION</th> <th>ACCESSORIES</th> </tr> </thead> <tbody> <tr> <td>105</td> <td>Doorstop w/ wool pile</td> <td>503 506-10</td> </tr> <tr> <td>150</td> <td>Clothes rail w/ plastic insert along top edge</td> <td></td> </tr> <tr> <td>202</td> <td>Double channel adaptor, slides down channel end</td> <td></td> </tr> <tr> <td>301</td> <td>Channel adaptor, for panels up to 37mm</td> <td></td> </tr> <tr> <td>304</td> <td>Channel adaptor for slatwall panels</td> <td></td> </tr> <tr> <td>312</td> <td>Spacer, fits to top of sliding glass doors</td> <td></td> </tr> <tr> <td>313</td> <td>In-channel clip for 326 and 327</td> <td></td> </tr> <tr> <td>315</td> <td>Channel infill, anodized aluminum finish</td> <td></td> </tr> <tr> <td>318</td> <td>Plastic Sliding Door Track 16MM - 13' - 4M Len.</td> <td></td> </tr> <tr> <td>319</td> <td>Plastic Sliding Door Track 6MM - 13' - 4M Len.</td> <td></td> </tr> <tr> <td>320-20</td> <td>Alum. Sliding Door Track - 20MM Wide</td> <td></td> </tr> <tr> <td>320-24</td> <td>Alum. Sliding Door Track - 24MM Wide</td> <td></td> </tr> <tr> <td>321</td> <td>Roller rail for sliding door assembly</td> <td>322 323 325 405</td> </tr> <tr> <td>322</td> <td>Roller carriage rail, Ball Bearing for 321</td> <td></td> </tr> <tr> <td>323</td> <td>Plastic end cap for 321</td> <td></td> </tr> <tr> <td>325</td> <td>Mitered corner cleat, for profile 321</td> <td></td> </tr> <tr> <td>326</td> <td>Lower Rail Profile for 321 (use 313)</td> <td></td> </tr> <tr> <td>327</td> <td>Upper Rail Profile for 321 (use 313)</td> <td></td> </tr> <tr> <td>327L</td> <td>Vertical edge Profile for 321 (use 313)</td> <td></td> </tr> <tr> <td>405</td> <td>Sliding door lock for profile 321</td> <td></td> </tr> <tr> <td>MTR</td> <td>Roller</td> <td></td> </tr> </tbody> </table> | | | PART # | DESCRIPTION | ACCESSORIES | 105 | Doorstop w/ wool pile | 503 506-10 | 150 | Clothes rail w/ plastic insert along top edge | | 202 | Double channel adaptor, slides down channel end | | 301 | Channel adaptor, for panels up to 37mm | | 304 | Channel adaptor for slatwall panels | | 312 | Spacer, fits to top of sliding glass doors | | 313 | In-channel clip for 326 and 327 | | 315 | Channel infill, anodized aluminum finish | | 318 | Plastic Sliding Door Track 16MM - 13' - 4M Len. | | 319 | Plastic Sliding Door Track 6MM - 13' - 4M Len. | | 320-20 | Alum. Sliding Door Track - 20MM Wide | | 320-24 | Alum. Sliding Door Track - 24MM Wide | | 321 | Roller rail for sliding door assembly | 322 323 325 405 | 322 | Roller carriage rail, Ball Bearing for 321 | | 323 | Plastic end cap for 321 | | 325 | Mitered corner cleat, for profile 321 | | 326 | Lower Rail Profile for 321 (use 313) | | 327 | Upper Rail Profile for 321 (use 313) | | 327L | Vertical edge Profile for 321 (use 313) | | 405 | Sliding door lock for profile 321 | | MTR | Roller | |
| PART # | DESCRIPTION | ACCESSORIES | | | | | | | | | | | | | | | | | | | | | | | | | | | | | | | | | | | | | | | | | | | | | | | | | | | | | | | | | | | | | | | | | | | | | |
| 105 | Doorstop w/ wool pile | 503 506-10 | | | | | | | | | | | | | | | | | | | | | | | | | | | | | | | | | | | | | | | | | | | | | | | | | | | | | | | | | | | | | | | | | | | | | |
| 150 | Clothes rail w/ plastic insert along top edge | | | | | | | | | | | | | | | | | | | | | | | | | | | | | | | | | | | | | | | | | | | | | | | | | | | | | | | | | | | | | | | | | | | | | | |
| 202 | Double channel adaptor, slides down channel end | | | | | | | | | | | | | | | | | | | | | | | | | | | | | | | | | | | | | | | | | | | | | | | | | | | | | | | | | | | | | | | | | | | | | | |
| 301 | Channel adaptor, for panels up to 37mm | | | | | | | | | | | | | | | | | | | | | | | | | | | | | | | | | | | | | | | | | | | | | | | | | | | | | | | | | | | | | | | | | | | | | | |
| 304 | Channel adaptor for slatwall panels | | | | | | | | | | | | | | | | | | | | | | | | | | | | | | | | | | | | | | | | | | | | | | | | | | | | | | | | | | | | | | | | | | | | | | |
| 312 | Spacer, fits to top of sliding glass doors | | | | | | | | | | | | | | | | | | | | | | | | | | | | | | | | | | | | | | | | | | | | | | | | | | | | | | | | | | | | | | | | | | | | | | |
| 313 | In-channel clip for 326 and 327 | | | | | | | | | | | | | | | | | | | | | | | | | | | | | | | | | | | | | | | | | | | | | | | | | | | | | | | | | | | | | | | | | | | | | | |
| 315 | Channel infill, anodized aluminum finish | | | | | | | | | | | | | | | | | | | | | | | | | | | | | | | | | | | | | | | | | | | | | | | | | | | | | | | | | | | | | | | | | | | | | | |
| 318 | Plastic Sliding Door Track 16MM - 13' - 4M Len. | | | | | | | | | | | | | | | | | | | | | | | | | | | | | | | | | | | | | | | | | | | | | | | | | | | | | | | | | | | | | | | | | | | | | | |
| 319 | Plastic Sliding Door Track 6MM - 13' - 4M Len. | | | | | | | | | | | | | | | | | | | | | | | | | | | | | | | | | | | | | | | | | | | | | | | | | | | | | | | | | | | | | | | | | | | | | | |
| 320-20 | Alum. Sliding Door Track - 20MM Wide | | | | | | | | | | | | | | | | | | | | | | | | | | | | | | | | | | | | | | | | | | | | | | | | | | | | | | | | | | | | | | | | | | | | | | |
| 320-24 | Alum. Sliding Door Track - 24MM Wide | | | | | | | | | | | | | | | | | | | | | | | | | | | | | | | | | | | | | | | | | | | | | | | | | | | | | | | | | | | | | | | | | | | | | | |
| 321 | Roller rail for sliding door assembly | 322 323 325 405 | | | | | | | | | | | | | | | | | | | | | | | | | | | | | | | | | | | | | | | | | | | | | | | | | | | | | | | | | | | | | | | | | | | | | |
| 322 | Roller carriage rail, Ball Bearing for 321 | | | | | | | | | | | | | | | | | | | | | | | | | | | | | | | | | | | | | | | | | | | | | | | | | | | | | | | | | | | | | | | | | | | | | | |
| 323 | Plastic end cap for 321 | | | | | | | | | | | | | | | | | | | | | | | | | | | | | | | | | | | | | | | | | | | | | | | | | | | | | | | | | | | | | | | | | | | | | | |
| 325 | Mitered corner cleat, for profile 321 | | | | | | | | | | | | | | | | | | | | | | | | | | | | | | | | | | | | | | | | | | | | | | | | | | | | | | | | | | | | | | | | | | | | | | |
| 326 | Lower Rail Profile for 321 (use 313) | | | | | | | | | | | | | | | | | | | | | | | | | | | | | | | | | | | | | | | | | | | | | | | | | | | | | | | | | | | | | | | | | | | | | | |
| 327 | Upper Rail Profile for 321 (use 313) | | | | | | | | | | | | | | | | | | | | | | | | | | | | | | | | | | | | | | | | | | | | | | | | | | | | | | | | | | | | | | | | | | | | | | |
| 327L | Vertical edge Profile for 321 (use 313) | | | | | | | | | | | | | | | | | | | | | | | | | | | | | | | | | | | | | | | | | | | | | | | | | | | | | | | | | | | | | | | | | | | | | | |
| 405 | Sliding door lock for profile 321 | | | | | | | | | | | | | | | | | | | | | | | | | | | | | | | | | | | | | | | | | | | | | | | | | | | | | | | | | | | | | | | | | | | | | | |
| MTR | Roller | | | | | | | | | | | | | | | | | | | | | | | | | | | | | | | | | | | | | | | | | | | | | | | | | | | | | | | | | | | | | | | | | | | | | | |
| <p>325</p> | <p>326</p> | <p>327</p> | | | | | | | | | | | | | | | | | | | | | | | | | | | | | | | | | | | | | | | | | | | | | | | | | | | | | | | | | | | | | | | | | | | | | |
| <p>327L</p> | <p>405</p> | <p>MTR</p> | | | | | | | | | | | | | | | | | | | | | | | | | | | | | | | | | | | | | | | | | | | | | | | | | | | | | | | | | | | | | | | | | | | | | |

■ End Cap ● Ceiling Jack ▲ Adjustable Foot ◆ Shelf Holder

CHANNEL SPECS: Channel Widths: 9mm (11/32") Channel Depths: 10mm (3/8")
CONVERSIONS: MM to IN: (MM ÷ 25.4) IN to MM: (IN x 25.4) MTR to FT: (MTR x 3.281) FT to MTR: (FT ÷ 3.281)

HINGES, LOCKS AND FEET

MOST ALUMINUM LENGTHS ARE STOCKED IN (5-MTR OR 16.4') LENGTHS

| | | | | | | |
|----------------|--|----------------|----------------|------------------------------|------------------------------|----------------|
| 402 | 403 | 408 | 410 | 411 412 | 415 416 | 420 |
| 630 | 700 703 705 | 701 | 702 | 707 708 | 726 | 710 |
| 710 | 720 | 726 | | | | |
| 765 | 766 | 876 | | | | |

| PART # | DESCRIPTION |
|--------|---|
| 402 | Pivot w/ grub screws |
| 403 | Hinge, for 20mm wide profiles w/ screws and bevel nuts |
| 408 | Hinged door lock, for 20mm profiles |
| 410 | Full height door lock, for use with profile 292 |
| 411 | Lock for Glass Door - Gold finish |
| 412 | Lock for Glass Door - Silver finish |
| 415 | Hinge for Glass Door - Gold finish |
| 416 | Hinge for Glass Door - Silver finish |
| 420 | Gear-edged hinge, 20mm x 20mm |
| 630 | Ceiling jack, secures top of uprights |
| 700 | Adjustable Foot, 40mm dia. base, M10 thread, for 90 series, |
| 701 | Aluminum foot insert, M8 thread, use w/ 708/profile 90 series |
| 702 | Aluminum foot insert, M8 thread, use w/ 707/profile 82 or 92LR series |
| 703 | Adjustable Foot, 40mm dia. base, M10 thread, use w/ 88 |
| 705 | Adjustable Foot, 40mm dia. base, M10 thread, use w/ 66 |
| 707 | Adjustable Foot, 20mm dia. base, M8 thread, use w/ 82 & 92LR |
| 708 | Adjustable Foot, 20mm dia. base, M8 thread, for 90 series, |
| 710 | Anodized aluminum foot 40 x 10 x 500mm |
| 720 | Anodized aluminum foot or shelf bracket 20 x 10 x 300mm |
| 726 | Base Mount Hardware M8 Bolt- 90 Series |
| 765 | Double caster w/ brake |
| 766 | Double caster without brake |
| 876 | Heavy duty hardened steel hand punch |

Grey Plastic Caps, unless noted

END CAPS *Anodized Aluminum **Frosted Green Silicone ***Black

| | | | | | | |
|-------------------------|-------------------------|------------------------------------|--------------------------------|-------------------|-----------------|------------------|
| T21L, T21R | T21AL, T21AR | T33 | T540 | T51 | T60 | T66 |
| T74** | T75S** | T82 | T85 | T88 | T90 | T91 |
| T91A | T92 | T92LA*** T92L | T92LR | T92R | T93 | T93R |
| T94 | T94R | T151 | T153 T154 | T180** | T194 | T194R |
| T164** and * | | | T190** | | | |

SHELF HOLDERS

| | | | |
|----------------|----------------|----------------|----------------|
| 510 | 514 | 520 | 525 |
| 530 | 550 | 590 | |

| PART # | DESCRIPTION |
|--------|--|
| 510 | Shelf holder for profiles 92L, 93 & 94 |
| 514 | Shelf holder for profiles 93 & 94 |
| 520 | Multi-purpose fixing bracket w/screw & 503 nut, mounts to FOGA channel |
| 525 | Shelf holder, fastens into R-Channel (92LR) |
| 530 | Shelf holder, fixes through pre-drilled hole in panels, two piece design |
| 550 | Shelf holder, fixes to the FOGA channel supplied w/screws & 503 bevel nuts |
| 590 | Shelf holder, extra long grub screw w/cap that forms shelf holder (for use w/600 connector only) |

CHANNEL SPECS: Channel Widths: 9mm (11/32") Channel Depths: 10mm (3/8")

CONVERSIONS: MM to IN: (MM ÷ 25.4) IN to MM: (IN x 25.4) MTR to FT: (MTR x 3.281) FT to MTR: (FT ÷ 3.281)

MOST ALUMINUM LENGTHS ARE STOCKED IN (5-MTR OR 16.4') LENGTHS

FOGA® The System with profile since 1965
SYSTEM

GLAZING GASKETS, TRIM LOCKING NUTS

| 125 | 126 | 130 | 130-30 | 136 | | | | | | | | | | | | | | | | | | | | | | | | | | | | | | | | | | | | | | | | | | | | | | | | | | | | | | |
|-------------------------------|---|----------------|-------------------|--|-------|-------------|-----|---|-----|---|-----|----------------------------------|--------|---------------------------------|-----|---|-----|---|-----|--|-----|---|-----|--|-----|---------------------------------|------|--|-----|----------------------------|-----|--------------------------|-----|--|-----|--|-----|------------------------------|-----|-------------------------------|-----|---------------------------------------|-----|--|-----|---|------|---|-----|-------------------------------------|------|--|-----|--------------------------------------|-----|---------------------------------|-----|---|
| 137 | 139 | 140 | 145 | <table border="1"> <thead> <tr> <th>PART#</th> <th>DESCRIPTION</th> </tr> </thead> <tbody> <tr><td>125</td><td>Flange adaptor, hooks over channel edge, 20mm</td></tr> <tr><td>126</td><td>Flange adaptor, hooks over channel edge, 10mm</td></tr> <tr><td>130</td><td>Shelf Bracket - 300mm Horizontal</td></tr> <tr><td>130-30</td><td>30° Angle shelf bracket - 300mm</td></tr> <tr><td>136</td><td>Channel infill, use w/ 313 in-channel clips</td></tr> <tr><td>137</td><td>Channel infill, use w/ 313 in-channel clips</td></tr> <tr><td>139</td><td>Channel infill, slides down channel end, mill finish</td></tr> <tr><td>140</td><td>30° Angle shelf bracket, anodized aluminum finish</td></tr> <tr><td>145</td><td>Shelf bracket, use w/ profiles painted gray finish</td></tr> <tr><td>230</td><td>Adjustable shelf bracket, 300mm</td></tr> <tr><td>230B</td><td>Adjustable shelf bracket, 300mm w/edge</td></tr> <tr><td>310</td><td>Spring Clip Panel Retainer</td></tr> <tr><td>329</td><td>Curtain Glides - 50 pcs.</td></tr> <tr><td>330</td><td>Glazing Rigid - Gray - For 3/16" to 1/4" Fill - 100"</td></tr> <tr><td>331</td><td>Glazing Rigid - Black- For 3/16" to 1/4" Fill - 100"</td></tr> <tr><td>339</td><td>Plastic channel infill, Gray</td></tr> <tr><td>340</td><td>Plastic channel infill, Black</td></tr> <tr><td>346</td><td>Black rubber gasket, for 3-4mm panels</td></tr> <tr><td>347</td><td>Two-piece plastic glazing gasket, Black, 13' - 4Mtr.</td></tr> <tr><td>355</td><td>Flange adaptor, Transparent - 13' - 4Mtr.</td></tr> <tr><td>403E</td><td>Tapered slotted steel screw MS 10 mm multiuse</td></tr> <tr><td>503</td><td>Beveled Edge Locking Nut, M5 thread</td></tr> <tr><td>503E</td><td>4mm socket head cap M5 - 10mm multiuse steel</td></tr> <tr><td>504</td><td>Beveled Edge Locking Nut (R-Channel)</td></tr> <tr><td>505</td><td>Standard Channel Nut, M8 thread</td></tr> <tr><td>551</td><td>Panel holder can also be used to hold graphic panels if rotated through 90°</td></tr> </tbody> </table> | PART# | DESCRIPTION | 125 | Flange adaptor, hooks over channel edge, 20mm | 126 | Flange adaptor, hooks over channel edge, 10mm | 130 | Shelf Bracket - 300mm Horizontal | 130-30 | 30° Angle shelf bracket - 300mm | 136 | Channel infill, use w/ 313 in-channel clips | 137 | Channel infill, use w/ 313 in-channel clips | 139 | Channel infill, slides down channel end, mill finish | 140 | 30° Angle shelf bracket, anodized aluminum finish | 145 | Shelf bracket, use w/ profiles painted gray finish | 230 | Adjustable shelf bracket, 300mm | 230B | Adjustable shelf bracket, 300mm w/edge | 310 | Spring Clip Panel Retainer | 329 | Curtain Glides - 50 pcs. | 330 | Glazing Rigid - Gray - For 3/16" to 1/4" Fill - 100" | 331 | Glazing Rigid - Black- For 3/16" to 1/4" Fill - 100" | 339 | Plastic channel infill, Gray | 340 | Plastic channel infill, Black | 346 | Black rubber gasket, for 3-4mm panels | 347 | Two-piece plastic glazing gasket, Black, 13' - 4Mtr. | 355 | Flange adaptor, Transparent - 13' - 4Mtr. | 403E | Tapered slotted steel screw MS 10 mm multiuse | 503 | Beveled Edge Locking Nut, M5 thread | 503E | 4mm socket head cap M5 - 10mm multiuse steel | 504 | Beveled Edge Locking Nut (R-Channel) | 505 | Standard Channel Nut, M8 thread | 551 | Panel holder can also be used to hold graphic panels if rotated through 90° |
| PART# | DESCRIPTION | | | | | | | | | | | | | | | | | | | | | | | | | | | | | | | | | | | | | | | | | | | | | | | | | | | | | | | | | |
| 125 | Flange adaptor, hooks over channel edge, 20mm | | | | | | | | | | | | | | | | | | | | | | | | | | | | | | | | | | | | | | | | | | | | | | | | | | | | | | | | | |
| 126 | Flange adaptor, hooks over channel edge, 10mm | | | | | | | | | | | | | | | | | | | | | | | | | | | | | | | | | | | | | | | | | | | | | | | | | | | | | | | | | |
| 130 | Shelf Bracket - 300mm Horizontal | | | | | | | | | | | | | | | | | | | | | | | | | | | | | | | | | | | | | | | | | | | | | | | | | | | | | | | | | |
| 130-30 | 30° Angle shelf bracket - 300mm | | | | | | | | | | | | | | | | | | | | | | | | | | | | | | | | | | | | | | | | | | | | | | | | | | | | | | | | | |
| 136 | Channel infill, use w/ 313 in-channel clips | | | | | | | | | | | | | | | | | | | | | | | | | | | | | | | | | | | | | | | | | | | | | | | | | | | | | | | | | |
| 137 | Channel infill, use w/ 313 in-channel clips | | | | | | | | | | | | | | | | | | | | | | | | | | | | | | | | | | | | | | | | | | | | | | | | | | | | | | | | | |
| 139 | Channel infill, slides down channel end, mill finish | | | | | | | | | | | | | | | | | | | | | | | | | | | | | | | | | | | | | | | | | | | | | | | | | | | | | | | | | |
| 140 | 30° Angle shelf bracket, anodized aluminum finish | | | | | | | | | | | | | | | | | | | | | | | | | | | | | | | | | | | | | | | | | | | | | | | | | | | | | | | | | |
| 145 | Shelf bracket, use w/ profiles painted gray finish | | | | | | | | | | | | | | | | | | | | | | | | | | | | | | | | | | | | | | | | | | | | | | | | | | | | | | | | | |
| 230 | Adjustable shelf bracket, 300mm | | | | | | | | | | | | | | | | | | | | | | | | | | | | | | | | | | | | | | | | | | | | | | | | | | | | | | | | | |
| 230B | Adjustable shelf bracket, 300mm w/edge | | | | | | | | | | | | | | | | | | | | | | | | | | | | | | | | | | | | | | | | | | | | | | | | | | | | | | | | | |
| 310 | Spring Clip Panel Retainer | | | | | | | | | | | | | | | | | | | | | | | | | | | | | | | | | | | | | | | | | | | | | | | | | | | | | | | | | |
| 329 | Curtain Glides - 50 pcs. | | | | | | | | | | | | | | | | | | | | | | | | | | | | | | | | | | | | | | | | | | | | | | | | | | | | | | | | | |
| 330 | Glazing Rigid - Gray - For 3/16" to 1/4" Fill - 100" | | | | | | | | | | | | | | | | | | | | | | | | | | | | | | | | | | | | | | | | | | | | | | | | | | | | | | | | | |
| 331 | Glazing Rigid - Black- For 3/16" to 1/4" Fill - 100" | | | | | | | | | | | | | | | | | | | | | | | | | | | | | | | | | | | | | | | | | | | | | | | | | | | | | | | | | |
| 339 | Plastic channel infill, Gray | | | | | | | | | | | | | | | | | | | | | | | | | | | | | | | | | | | | | | | | | | | | | | | | | | | | | | | | | |
| 340 | Plastic channel infill, Black | | | | | | | | | | | | | | | | | | | | | | | | | | | | | | | | | | | | | | | | | | | | | | | | | | | | | | | | | |
| 346 | Black rubber gasket, for 3-4mm panels | | | | | | | | | | | | | | | | | | | | | | | | | | | | | | | | | | | | | | | | | | | | | | | | | | | | | | | | | |
| 347 | Two-piece plastic glazing gasket, Black, 13' - 4Mtr. | | | | | | | | | | | | | | | | | | | | | | | | | | | | | | | | | | | | | | | | | | | | | | | | | | | | | | | | | |
| 355 | Flange adaptor, Transparent - 13' - 4Mtr. | | | | | | | | | | | | | | | | | | | | | | | | | | | | | | | | | | | | | | | | | | | | | | | | | | | | | | | | | |
| 403E | Tapered slotted steel screw MS 10 mm multiuse | | | | | | | | | | | | | | | | | | | | | | | | | | | | | | | | | | | | | | | | | | | | | | | | | | | | | | | | | |
| 503 | Beveled Edge Locking Nut, M5 thread | | | | | | | | | | | | | | | | | | | | | | | | | | | | | | | | | | | | | | | | | | | | | | | | | | | | | | | | | |
| 503E | 4mm socket head cap M5 - 10mm multiuse steel | | | | | | | | | | | | | | | | | | | | | | | | | | | | | | | | | | | | | | | | | | | | | | | | | | | | | | | | | |
| 504 | Beveled Edge Locking Nut (R-Channel) | | | | | | | | | | | | | | | | | | | | | | | | | | | | | | | | | | | | | | | | | | | | | | | | | | | | | | | | | |
| 505 | Standard Channel Nut, M8 thread | | | | | | | | | | | | | | | | | | | | | | | | | | | | | | | | | | | | | | | | | | | | | | | | | | | | | | | | | |
| 551 | Panel holder can also be used to hold graphic panels if rotated through 90° | | | | | | | | | | | | | | | | | | | | | | | | | | | | | | | | | | | | | | | | | | | | | | | | | | | | | | | | | |
| 230 230B | 310 | 329 | | | | | | | | | | | | | | | | | | | | | | | | | | | | | | | | | | | | | | | | | | | | | | | | | | | | | | | | |
| 330 331 | 339 340 | 346 | 347 | | | | | | | | | | | | | | | | | | | | | | | | | | | | | | | | | | | | | | | | | | | | | | | | | | | | | | | |
| 355 | 403E | 503 | 503E | | | | | | | | | | | | | | | | | | | | | | | | | | | | | | | | | | | | | | | | | | | | | | | | | | | | | | | |
| 504 | 505 | 551 | | | | | | | | | | | | | | | | | | | | | | | | | | | | | | | | | | | | | | | | | | | | | | | | | | | | | | | | |

CORNER COUPLINGS

| | | | |
|----------------|---|---------------------|--|
| 851 | 950 | 952, 953 | END CAPS - PLASTIC (unless otherwise noted) |
| PART # | DESCRIPTION | PART # | DESCRIPTION |
| 851 | Steel Hex Key / 3mm shortarm for use with 950° corner | T952B | Zinc, Glossy Chrome w/screw 82, 92LR(F) |
| 950 | Corner Connector | T952Z | Zinc, Unfinished w/screw 82, 92LR(F) |
| 952 | Corner Connector - 135° for 92LR | T953B | Zinc, Glossy Chrome w/screw 82, 60 |
| 953 | Corner Connector - 135° for 60 | T953Z | Zinc, Unfinished w/screw 82, 60 |
| | | T951B | Zinc, Glossy Chrome w/screw 92LR(F) |
| | | T951M | Zinc, Matte Chrome w/screw 92LR(F) |
| | | T951Z | Zinc, Unfinished w/screw 92LR(F) |
| | | T951SB | Plastic, Glossy Chrome w/screw 92LR(F) |
| | | T951SBG | Plastic, Glossy Gold w/screw 92LR(F) |
| | | T960 | Plastic, Glossy Black, Snap 92LR(F) |
| | | T960B | Zinc, Glossy Chrome w/screw 60 |
| | | T960Z | Zinc, Unfinished w/screw 60 |
| | | T960SB | Plastic, Glossy Chrome w/screw 60 |
| | | T960SBG | Plastic, Glossy Gold w/screw 60 |
| | | T961 | Plastic, Matte Chrome, Snap 92LR(F) |
| | | T962 | Plastic, Glossy Chrome, Snap 60 |
| | | T963 | Plastic, Matte Chrome, Snap 60 |
| | | T964 | Plastic, Glossy Black, Snap 92L, 92R |
| | | T965 | Plastic, Matte Chrome, Snap 194R |
| | | T966 | Plastic, Matte Chrome, Snap 194R |
| | | T967 | Plastic, Matte Chrome, Snap 92L, 92R |
| | | T968 | Plastic, Glossy Chrome, Snap 194R |
| | | T969 | Plastic, Glossy Chrome, Snap 92LR(F) |
| | | T970 | Plastic, Glossy Chrome, Snap 60 |
| | | T971 | Plastic, Glossy Chrome, Snap 92L, 92R |

CHANNEL SPECS: Channel Widths: 9mm (11/32") Channel Depths: 10mm (3/8")

CONVERSIONS: MM to IN: (MM ÷ 25.4) IN to MM: (IN x 25.4) MTR to FT: (MTR x 3.281) FT to MTR: (FT ÷ 3.281)

COUPLINGS

MOST ALUMINUM LENGTHS ARE STOCKED IN (5-MTR OR 16.4') LENGTHS

| | | | | | <table border="1"> <thead> <tr> <th>PART #</th> <th>DESCRIPTION</th> </tr> </thead> <tbody> <tr><td>600</td><td>Connector, with adjustable head</td></tr> <tr><td>600R</td><td>Round-head bolt, for 600 connector</td></tr> <tr><td>600G</td><td>Pivot-head bolt, for 600 connector</td></tr> <tr><td>601</td><td>Joint connector</td></tr> <tr><td>604</td><td>Joint Connector Flange</td></tr> <tr><td>605</td><td>90° Internal connector, for mitered corner joint</td></tr> <tr><td>607</td><td>Multi Purpose Connector</td></tr> <tr><td>608</td><td>Connector, expanding jaw locking method (1 pc.)</td></tr> <tr><td>608B</td><td>Connector, expanding jaw locking method (2 pc.)</td></tr> <tr><td>608AR</td><td>Connector - 45° (right)</td></tr> <tr><td>608AL</td><td>Connector - 45° (left)</td></tr> <tr><td>609</td><td>Joint Connector</td></tr> <tr><td>610</td><td>90° connector, for joining mitered corners</td></tr> <tr><td>610G</td><td>Aluminum 90° angle connector - square stock without angles</td></tr> <tr><td>612</td><td>90° connector, for joining mitered corners, use w/ 91A, 92A</td></tr> <tr><td>613</td><td>90° connector, for joining mitered corners (flat)</td></tr> <tr><td>615A</td><td>Connector-Drawer Type (perpendicular)</td></tr> <tr><td>615B</td><td>Connector-Drawer Type (parallel)</td></tr> <tr><td>618</td><td>Parallel Connector</td></tr> <tr><td>624</td><td>Internal adjustable mitered corner coupling</td></tr> <tr><td>625</td><td>Internal mitered corner coupling, for 90° Angle</td></tr> <tr><td>540</td><td>Hanging clip, to produce butt joints (e.g. on ceiling grids)</td></tr> <tr><td>850</td><td>Steel Hex Key - 4mm Short Arm</td></tr> </tbody> </table> | PART # | DESCRIPTION | 600 | Connector, with adjustable head | 600R | Round-head bolt, for 600 connector | 600G | Pivot-head bolt, for 600 connector | 601 | Joint connector | 604 | Joint Connector Flange | 605 | 90° Internal connector, for mitered corner joint | 607 | Multi Purpose Connector | 608 | Connector, expanding jaw locking method (1 pc.) | 608B | Connector, expanding jaw locking method (2 pc.) | 608AR | Connector - 45° (right) | 608AL | Connector - 45° (left) | 609 | Joint Connector | 610 | 90° connector, for joining mitered corners | 610G | Aluminum 90° angle connector - square stock without angles | 612 | 90° connector, for joining mitered corners, use w/ 91A, 92A | 613 | 90° connector, for joining mitered corners (flat) | 615A | Connector-Drawer Type (perpendicular) | 615B | Connector-Drawer Type (parallel) | 618 | Parallel Connector | 624 | Internal adjustable mitered corner coupling | 625 | Internal mitered corner coupling, for 90° Angle | 540 | Hanging clip, to produce butt joints (e.g. on ceiling grids) | 850 | Steel Hex Key - 4mm Short Arm |
|--------|--|--|--|--|---|--------|-------------|-----|---------------------------------|------|------------------------------------|------|------------------------------------|-----|-----------------|-----|------------------------|-----|--|-----|-------------------------|-----|---|------|---|-------|-------------------------|-------|------------------------|-----|-----------------|-----|--|------|--|-----|---|-----|---|------|---------------------------------------|------|----------------------------------|-----|--------------------|-----|---|-----|---|-----|--|-----|-------------------------------|
| PART # | DESCRIPTION | | | | | | | | | | | | | | | | | | | | | | | | | | | | | | | | | | | | | | | | | | | | | | | | | | | | |
| 600 | Connector, with adjustable head | | | | | | | | | | | | | | | | | | | | | | | | | | | | | | | | | | | | | | | | | | | | | | | | | | | | |
| 600R | Round-head bolt, for 600 connector | | | | | | | | | | | | | | | | | | | | | | | | | | | | | | | | | | | | | | | | | | | | | | | | | | | | |
| 600G | Pivot-head bolt, for 600 connector | | | | | | | | | | | | | | | | | | | | | | | | | | | | | | | | | | | | | | | | | | | | | | | | | | | | |
| 601 | Joint connector | | | | | | | | | | | | | | | | | | | | | | | | | | | | | | | | | | | | | | | | | | | | | | | | | | | | |
| 604 | Joint Connector Flange | | | | | | | | | | | | | | | | | | | | | | | | | | | | | | | | | | | | | | | | | | | | | | | | | | | | |
| 605 | 90° Internal connector, for mitered corner joint | | | | | | | | | | | | | | | | | | | | | | | | | | | | | | | | | | | | | | | | | | | | | | | | | | | | |
| 607 | Multi Purpose Connector | | | | | | | | | | | | | | | | | | | | | | | | | | | | | | | | | | | | | | | | | | | | | | | | | | | | |
| 608 | Connector, expanding jaw locking method (1 pc.) | | | | | | | | | | | | | | | | | | | | | | | | | | | | | | | | | | | | | | | | | | | | | | | | | | | | |
| 608B | Connector, expanding jaw locking method (2 pc.) | | | | | | | | | | | | | | | | | | | | | | | | | | | | | | | | | | | | | | | | | | | | | | | | | | | | |
| 608AR | Connector - 45° (right) | | | | | | | | | | | | | | | | | | | | | | | | | | | | | | | | | | | | | | | | | | | | | | | | | | | | |
| 608AL | Connector - 45° (left) | | | | | | | | | | | | | | | | | | | | | | | | | | | | | | | | | | | | | | | | | | | | | | | | | | | | |
| 609 | Joint Connector | | | | | | | | | | | | | | | | | | | | | | | | | | | | | | | | | | | | | | | | | | | | | | | | | | | | |
| 610 | 90° connector, for joining mitered corners | | | | | | | | | | | | | | | | | | | | | | | | | | | | | | | | | | | | | | | | | | | | | | | | | | | | |
| 610G | Aluminum 90° angle connector - square stock without angles | | | | | | | | | | | | | | | | | | | | | | | | | | | | | | | | | | | | | | | | | | | | | | | | | | | | |
| 612 | 90° connector, for joining mitered corners, use w/ 91A, 92A | | | | | | | | | | | | | | | | | | | | | | | | | | | | | | | | | | | | | | | | | | | | | | | | | | | | |
| 613 | 90° connector, for joining mitered corners (flat) | | | | | | | | | | | | | | | | | | | | | | | | | | | | | | | | | | | | | | | | | | | | | | | | | | | | |
| 615A | Connector-Drawer Type (perpendicular) | | | | | | | | | | | | | | | | | | | | | | | | | | | | | | | | | | | | | | | | | | | | | | | | | | | | |
| 615B | Connector-Drawer Type (parallel) | | | | | | | | | | | | | | | | | | | | | | | | | | | | | | | | | | | | | | | | | | | | | | | | | | | | |
| 618 | Parallel Connector | | | | | | | | | | | | | | | | | | | | | | | | | | | | | | | | | | | | | | | | | | | | | | | | | | | | |
| 624 | Internal adjustable mitered corner coupling | | | | | | | | | | | | | | | | | | | | | | | | | | | | | | | | | | | | | | | | | | | | | | | | | | | | |
| 625 | Internal mitered corner coupling, for 90° Angle | | | | | | | | | | | | | | | | | | | | | | | | | | | | | | | | | | | | | | | | | | | | | | | | | | | | |
| 540 | Hanging clip, to produce butt joints (e.g. on ceiling grids) | | | | | | | | | | | | | | | | | | | | | | | | | | | | | | | | | | | | | | | | | | | | | | | | | | | | |
| 850 | Steel Hex Key - 4mm Short Arm | | | | | | | | | | | | | | | | | | | | | | | | | | | | | | | | | | | | | | | | | | | | | | | | | | | | |
| | | | | | | | | | | | | | | | | | | | | | | | | | | | | | | | | | | | | | | | | | | | | | | | | | | | | | |
| | | | | | | | | | | | | | | | | | | | | | | | | | | | | | | | | | | | | | | | | | | | | | | | | | | | | | |

SLIDING DOOR FITTINGS

| | | | <table border="1"> <thead> <tr> <th>PART #</th> <th>DESCRIPTION</th> </tr> </thead> <tbody> <tr><td>70</td><td>Single channel sliding door track</td></tr> <tr><td>72</td><td>Double channel sliding door track</td></tr> <tr><td>73</td><td>Triple Channel Sliding Door Track</td></tr> <tr><td>101</td><td>Threshold rail w/ single channel</td></tr> <tr><td>102</td><td>Threshold rail w/ double channel</td></tr> <tr><td>104</td><td>U-Profile</td></tr> <tr><td>740</td><td>Black rubber seal, for profiles 70 & 72</td></tr> <tr><td>741</td><td>Wool Pile For Door Seal</td></tr> <tr><td>752</td><td>Roller carriage for profile 70, 72 & 73</td></tr> <tr><td>760</td><td>Stops for profiles 70, 72 & 73</td></tr> <tr><td>764</td><td>Steering pin for profiles 70 & 72</td></tr> </tbody> </table> | | PART # | DESCRIPTION | 70 | Single channel sliding door track | 72 | Double channel sliding door track | 73 | Triple Channel Sliding Door Track | 101 | Threshold rail w/ single channel | 102 | Threshold rail w/ double channel | 104 | U-Profile | 740 | Black rubber seal, for profiles 70 & 72 | 741 | Wool Pile For Door Seal | 752 | Roller carriage for profile 70, 72 & 73 | 760 | Stops for profiles 70, 72 & 73 | 764 | Steering pin for profiles 70 & 72 |
|--------|---|--|---|--|--------|-------------|----|-----------------------------------|----|-----------------------------------|----|-----------------------------------|-----|----------------------------------|-----|----------------------------------|-----|-----------|-----|---|-----|-------------------------|-----|---|-----|--------------------------------|-----|-----------------------------------|
| PART # | DESCRIPTION | | | | | | | | | | | | | | | | | | | | | | | | | | | |
| 70 | Single channel sliding door track | | | | | | | | | | | | | | | | | | | | | | | | | | | |
| 72 | Double channel sliding door track | | | | | | | | | | | | | | | | | | | | | | | | | | | |
| 73 | Triple Channel Sliding Door Track | | | | | | | | | | | | | | | | | | | | | | | | | | | |
| 101 | Threshold rail w/ single channel | | | | | | | | | | | | | | | | | | | | | | | | | | | |
| 102 | Threshold rail w/ double channel | | | | | | | | | | | | | | | | | | | | | | | | | | | |
| 104 | U-Profile | | | | | | | | | | | | | | | | | | | | | | | | | | | |
| 740 | Black rubber seal, for profiles 70 & 72 | | | | | | | | | | | | | | | | | | | | | | | | | | | |
| 741 | Wool Pile For Door Seal | | | | | | | | | | | | | | | | | | | | | | | | | | | |
| 752 | Roller carriage for profile 70, 72 & 73 | | | | | | | | | | | | | | | | | | | | | | | | | | | |
| 760 | Stops for profiles 70, 72 & 73 | | | | | | | | | | | | | | | | | | | | | | | | | | | |
| 764 | Steering pin for profiles 70 & 72 | | | | | | | | | | | | | | | | | | | | | | | | | | | |

FOGA® SYSTEMS

CHANNEL SPECS: Channel Widths: 9mm (11/32") Channel Depths: 10mm (3/8")

CONVERSIONS: MM to IN: (MM ÷ 25.4) IN to MM: (IN x 25.4) MTR to FT: (MTR x 3.281) FT to MTR: (FT ÷ 3.281)

FOGA® The System with profile since 1985
SYSTEM

MOST ALUMINUM LENGTHS ARE STOCKED IN (5-MTR OR 16.4') LENGTHS

FOGA® 21, FOGA® 21A, FOGA® 33

| 21 | 21-1 | 21-3 | 21-A | 33 | | | | | | | | | | | | | | | | | | | | | | | | | | | | | | | | | | | | | | | | | | | | | | | | |
|------------------|--|----------------------------------|---------------------------------|---|-------|-------------|----|--------------------------------|------|--------------------|------|----------------------------|------|--------------------------------|----|-------------------------------|-----|--|-----|--|-------|--|------|-------------------------------------|-------|--|-------|---------------|------|-----------------------------------|-------|---------------|-------|---------------------------|------|--------------------------|-------|---|-------|--------------------------|------|--------------------------------|------|----------------|-------|---|------|-----------------------------------|-------|--|------|-------------------------------------|
| 91A | 92A | 600AC | 621A 621AG | <table border="1"> <thead> <tr> <th>PART#</th> <th>DESCRIPTION</th> </tr> </thead> <tbody> <tr><td>21</td><td>Lightweight gear-edged profile</td></tr> <tr><td>21-1</td><td>Gear-edged profile</td></tr> <tr><td>21-3</td><td>Gear-edged profile (3 way)</td></tr> <tr><td>21-A</td><td>Lightweight gear-edged profile</td></tr> <tr><td>33</td><td>Heavy Duty gear-edged profile</td></tr> <tr><td>91A</td><td>Horizontal or vertical, one way, use 600AC</td></tr> <tr><td>92A</td><td>Horizontal or vertical, two way, use 600AC</td></tr> <tr><td>600AC</td><td>Slimline design connector for 91A, 92A</td></tr> <tr><td>621A</td><td>Hinging pins & plate for profile 21</td></tr> <tr><td>621AG</td><td>Hinging pins & wide plate for profile 21</td></tr> <tr><td>621ME</td><td>Single spigot</td></tr> <tr><td>621M</td><td>Aluminum Stack pin for profile 21</td></tr> <tr><td>621MD</td><td>Double spigot</td></tr> <tr><td>621AS</td><td>Plastic Stack Pin for 21A</td></tr> <tr><td>621S</td><td>Plastic Stack Pin (60mm)</td></tr> <tr><td>621SA</td><td>Aluminum Stack Pin for profile 21 & 21A</td></tr> <tr><td>621SK</td><td>Plastic Stack Pin (30mm)</td></tr> <tr><td>621F</td><td>Black rubber foot For 21 & 21A</td></tr> <tr><td>621L</td><td>Snap-on poster</td></tr> <tr><td>621LA</td><td>Snap-on poster for profile 21A, 91A & 92A</td></tr> <tr><td>621P</td><td>Sliding door track for profile 21</td></tr> <tr><td>621PA</td><td>Sliding door track for profile 21A & 91A</td></tr> <tr><td>633A</td><td>Hinging pins & plate for profile 33</td></tr> </tbody> </table> | PART# | DESCRIPTION | 21 | Lightweight gear-edged profile | 21-1 | Gear-edged profile | 21-3 | Gear-edged profile (3 way) | 21-A | Lightweight gear-edged profile | 33 | Heavy Duty gear-edged profile | 91A | Horizontal or vertical, one way, use 600AC | 92A | Horizontal or vertical, two way, use 600AC | 600AC | Slimline design connector for 91A, 92A | 621A | Hinging pins & plate for profile 21 | 621AG | Hinging pins & wide plate for profile 21 | 621ME | Single spigot | 621M | Aluminum Stack pin for profile 21 | 621MD | Double spigot | 621AS | Plastic Stack Pin for 21A | 621S | Plastic Stack Pin (60mm) | 621SA | Aluminum Stack Pin for profile 21 & 21A | 621SK | Plastic Stack Pin (30mm) | 621F | Black rubber foot For 21 & 21A | 621L | Snap-on poster | 621LA | Snap-on poster for profile 21A, 91A & 92A | 621P | Sliding door track for profile 21 | 621PA | Sliding door track for profile 21A & 91A | 633A | Hinging pins & plate for profile 33 |
| PART# | DESCRIPTION | | | | | | | | | | | | | | | | | | | | | | | | | | | | | | | | | | | | | | | | | | | | | | | | | | | |
| 21 | Lightweight gear-edged profile | | | | | | | | | | | | | | | | | | | | | | | | | | | | | | | | | | | | | | | | | | | | | | | | | | | |
| 21-1 | Gear-edged profile | | | | | | | | | | | | | | | | | | | | | | | | | | | | | | | | | | | | | | | | | | | | | | | | | | | |
| 21-3 | Gear-edged profile (3 way) | | | | | | | | | | | | | | | | | | | | | | | | | | | | | | | | | | | | | | | | | | | | | | | | | | | |
| 21-A | Lightweight gear-edged profile | | | | | | | | | | | | | | | | | | | | | | | | | | | | | | | | | | | | | | | | | | | | | | | | | | | |
| 33 | Heavy Duty gear-edged profile | | | | | | | | | | | | | | | | | | | | | | | | | | | | | | | | | | | | | | | | | | | | | | | | | | | |
| 91A | Horizontal or vertical, one way, use 600AC | | | | | | | | | | | | | | | | | | | | | | | | | | | | | | | | | | | | | | | | | | | | | | | | | | | |
| 92A | Horizontal or vertical, two way, use 600AC | | | | | | | | | | | | | | | | | | | | | | | | | | | | | | | | | | | | | | | | | | | | | | | | | | | |
| 600AC | Slimline design connector for 91A, 92A | | | | | | | | | | | | | | | | | | | | | | | | | | | | | | | | | | | | | | | | | | | | | | | | | | | |
| 621A | Hinging pins & plate for profile 21 | | | | | | | | | | | | | | | | | | | | | | | | | | | | | | | | | | | | | | | | | | | | | | | | | | | |
| 621AG | Hinging pins & wide plate for profile 21 | | | | | | | | | | | | | | | | | | | | | | | | | | | | | | | | | | | | | | | | | | | | | | | | | | | |
| 621ME | Single spigot | | | | | | | | | | | | | | | | | | | | | | | | | | | | | | | | | | | | | | | | | | | | | | | | | | | |
| 621M | Aluminum Stack pin for profile 21 | | | | | | | | | | | | | | | | | | | | | | | | | | | | | | | | | | | | | | | | | | | | | | | | | | | |
| 621MD | Double spigot | | | | | | | | | | | | | | | | | | | | | | | | | | | | | | | | | | | | | | | | | | | | | | | | | | | |
| 621AS | Plastic Stack Pin for 21A | | | | | | | | | | | | | | | | | | | | | | | | | | | | | | | | | | | | | | | | | | | | | | | | | | | |
| 621S | Plastic Stack Pin (60mm) | | | | | | | | | | | | | | | | | | | | | | | | | | | | | | | | | | | | | | | | | | | | | | | | | | | |
| 621SA | Aluminum Stack Pin for profile 21 & 21A | | | | | | | | | | | | | | | | | | | | | | | | | | | | | | | | | | | | | | | | | | | | | | | | | | | |
| 621SK | Plastic Stack Pin (30mm) | | | | | | | | | | | | | | | | | | | | | | | | | | | | | | | | | | | | | | | | | | | | | | | | | | | |
| 621F | Black rubber foot For 21 & 21A | | | | | | | | | | | | | | | | | | | | | | | | | | | | | | | | | | | | | | | | | | | | | | | | | | | |
| 621L | Snap-on poster | | | | | | | | | | | | | | | | | | | | | | | | | | | | | | | | | | | | | | | | | | | | | | | | | | | |
| 621LA | Snap-on poster for profile 21A, 91A & 92A | | | | | | | | | | | | | | | | | | | | | | | | | | | | | | | | | | | | | | | | | | | | | | | | | | | |
| 621P | Sliding door track for profile 21 | | | | | | | | | | | | | | | | | | | | | | | | | | | | | | | | | | | | | | | | | | | | | | | | | | | |
| 621PA | Sliding door track for profile 21A & 91A | | | | | | | | | | | | | | | | | | | | | | | | | | | | | | | | | | | | | | | | | | | | | | | | | | | |
| 633A | Hinging pins & plate for profile 33 | | | | | | | | | | | | | | | | | | | | | | | | | | | | | | | | | | | | | | | | | | | | | | | | | | | |
| 621M | 621MD | 621AS 621SA | 621S | | | | | | | | | | | | | | | | | | | | | | | | | | | | | | | | | | | | | | | | | | | | | | | | | |
| 621ME | 621F | 621L | 621LA | | | | | | | | | | | | | | | | | | | | | | | | | | | | | | | | | | | | | | | | | | | | | | | | | |
| 621P | 621PA | 633A | | | | | | | | | | | | | | | | | | | | | | | | | | | | | | | | | | | | | | | | | | | | | | | | | | |

FOGA® MINI

| M21 | M91 | M92 | M92LR | M318 | M319 | M525 | | | | | | | | | | | | | | | | | | | | | | | | | | | | | | | | | | | | |
|----------------------------------|---|----------------------------------|------------------|-----------------|--|-----------------|-------------|-----|-------------------------------|-----|---|-----|---|-------|--------------------|------|--|------|--------------------------------------|------|-------------------------|-------|--------------------------------------|-------|--------------------------------------|------|--------------------------------|-------|-------------------|-------|---------------------------|------|-----------------------------|------|------------------------------|------|--------------------------------|-------|--|-------|---|--|
| M600A M600B | M610 | M621A | M621F | M625 | <table border="1"> <thead> <tr> <th>PART#</th> <th>DESCRIPTION</th> </tr> </thead> <tbody> <tr><td>M21</td><td>Ultralight Gear-edged profile</td></tr> <tr><td>M91</td><td>Horizontal or vertical, one way profile</td></tr> <tr><td>M92</td><td>Horizontal or vertical, two way profile</td></tr> <tr><td>M92LR</td><td>90° Corner Channel</td></tr> <tr><td>M318</td><td>Plastic Sliding Door Track (12mm deep)</td></tr> <tr><td>M319</td><td>Plastic Sliding Door Track(6mm deep)</td></tr> <tr><td>M525</td><td>Shelf Holder, for M92LR</td></tr> <tr><td>M600A</td><td>Connector For M91 & M92 (horz. head)</td></tr> <tr><td>M600B</td><td>Connector For M91 & M92 (vert. head)</td></tr> <tr><td>M610</td><td>90° in-channel corner coupling</td></tr> <tr><td>M621A</td><td>Hinge set for M21</td></tr> <tr><td>M621F</td><td>Black rubber foot for M21</td></tr> <tr><td>M625</td><td>90° Mitered Corner Coupling</td></tr> <tr><td>M707</td><td>Black plastic foot for M92LR</td></tr> <tr><td>M872</td><td>Drilling Tool For M600A, M600B</td></tr> <tr><td>M950B</td><td>Plastic corner knuckle for M92LR, black finish</td></tr> <tr><td>M950C</td><td>Plastic corner knuckle for M92LR, chrome finish</td></tr> </tbody> </table> | PART# | DESCRIPTION | M21 | Ultralight Gear-edged profile | M91 | Horizontal or vertical, one way profile | M92 | Horizontal or vertical, two way profile | M92LR | 90° Corner Channel | M318 | Plastic Sliding Door Track (12mm deep) | M319 | Plastic Sliding Door Track(6mm deep) | M525 | Shelf Holder, for M92LR | M600A | Connector For M91 & M92 (horz. head) | M600B | Connector For M91 & M92 (vert. head) | M610 | 90° in-channel corner coupling | M621A | Hinge set for M21 | M621F | Black rubber foot for M21 | M625 | 90° Mitered Corner Coupling | M707 | Black plastic foot for M92LR | M872 | Drilling Tool For M600A, M600B | M950B | Plastic corner knuckle for M92LR, black finish | M950C | Plastic corner knuckle for M92LR, chrome finish | |
| PART# | DESCRIPTION | | | | | | | | | | | | | | | | | | | | | | | | | | | | | | | | | | | | | | | | | |
| M21 | Ultralight Gear-edged profile | | | | | | | | | | | | | | | | | | | | | | | | | | | | | | | | | | | | | | | | | |
| M91 | Horizontal or vertical, one way profile | | | | | | | | | | | | | | | | | | | | | | | | | | | | | | | | | | | | | | | | | |
| M92 | Horizontal or vertical, two way profile | | | | | | | | | | | | | | | | | | | | | | | | | | | | | | | | | | | | | | | | | |
| M92LR | 90° Corner Channel | | | | | | | | | | | | | | | | | | | | | | | | | | | | | | | | | | | | | | | | | |
| M318 | Plastic Sliding Door Track (12mm deep) | | | | | | | | | | | | | | | | | | | | | | | | | | | | | | | | | | | | | | | | | |
| M319 | Plastic Sliding Door Track(6mm deep) | | | | | | | | | | | | | | | | | | | | | | | | | | | | | | | | | | | | | | | | | |
| M525 | Shelf Holder, for M92LR | | | | | | | | | | | | | | | | | | | | | | | | | | | | | | | | | | | | | | | | | |
| M600A | Connector For M91 & M92 (horz. head) | | | | | | | | | | | | | | | | | | | | | | | | | | | | | | | | | | | | | | | | | |
| M600B | Connector For M91 & M92 (vert. head) | | | | | | | | | | | | | | | | | | | | | | | | | | | | | | | | | | | | | | | | | |
| M610 | 90° in-channel corner coupling | | | | | | | | | | | | | | | | | | | | | | | | | | | | | | | | | | | | | | | | | |
| M621A | Hinge set for M21 | | | | | | | | | | | | | | | | | | | | | | | | | | | | | | | | | | | | | | | | | |
| M621F | Black rubber foot for M21 | | | | | | | | | | | | | | | | | | | | | | | | | | | | | | | | | | | | | | | | | |
| M625 | 90° Mitered Corner Coupling | | | | | | | | | | | | | | | | | | | | | | | | | | | | | | | | | | | | | | | | | |
| M707 | Black plastic foot for M92LR | | | | | | | | | | | | | | | | | | | | | | | | | | | | | | | | | | | | | | | | | |
| M872 | Drilling Tool For M600A, M600B | | | | | | | | | | | | | | | | | | | | | | | | | | | | | | | | | | | | | | | | | |
| M950B | Plastic corner knuckle for M92LR, black finish | | | | | | | | | | | | | | | | | | | | | | | | | | | | | | | | | | | | | | | | | |
| M950C | Plastic corner knuckle for M92LR, chrome finish | | | | | | | | | | | | | | | | | | | | | | | | | | | | | | | | | | | | | | | | | |
| M707 | M872 | M950B M950C | | | | | | | | | | | | | | | | | | | | | | | | | | | | | | | | | | | | | | | | |

FOGA® IS A BUILDING SYSTEM FULLY INTEGRATED AND MODULAR. ITS WIDE RANGE OF ALUMINIUM PROFILES AND UNIQUE PATENTED COUPLING MAKES IT A COMPLETE PROGRAM FOR EXHIBITIONS, SHOPFITTING AND INTERIOR DESIGN.



BUILD OFFICE PARTITIONS; BUILD FURNITURE, SHOWCASES, DISPLAY CABINETS, MERCHANDISING UNITS, SALES KIOSKS - THE LIST IS ENDLESS; ALL IT TAKES IS CREATIVITY - THE KIND YOU HAVE WITH FOGA®.

FOGA® IS AESTHETICALLY DESIGNED, PRECISION ENGINEERED AND ANODIZED IN NATURAL ALUMINIUM TO OFFER DESIGNERS COMPLETE FLEXIBILITY IN DESIGN AND CREATIVITY.

FOGA®-System... No other way makes it so easy!

FOGA®'s wide range of aluminium extrusions and components offers limitless expression to both the designer's dilemma and the craftsman's creativity. With FOGA® even non-standard designs provide maximum scope for adaption and reuse and the system's speed and ease of assembly help to minimize construction and installation costs.

Superior Strength of the FOGA® System

The FOGA® coupling system gains its superior locking strength through two main features:

- (a) The 3 mm profile shoulders.
- (b) The double locking faces of the locking which positively engage against both shoulders ensures that profile being coupled are square to each other at all times.

The Key to FOGA® Assembly

The key to FOGA® assembly is the exclusive FOGA® coupling. All extrusions have channels to accept the coupling providing infinite adjustments and flexibility. The coupling itself can be fitted to any extrusion which has the 20 mm x 20 mm square built into its shape. The only tool needed to assemble FOGA® is an allen key. Illustrated is FOGA® Profile 91. **A 10 mm hole is punched or drilled 28.6 mm from the end of the profile to the center of the hole.** The consistency of these measurements allows for the coupling to be inserted in all appropriate FOGA® Profiles and ensures accuracy of performance at all times.

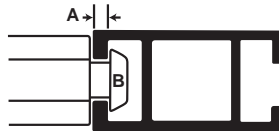

FOGA® System profile 91, already fitted with the patented FOGA® coupling, being engaged simply and speedily into profile 88. Insertion of the coupling bolt (a 90 degree turn and tightening with an alien key) produces a rigid and stable connection in all FOGA® constructions.

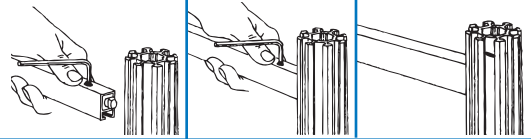

THE PATENT FOGA® COUPLING 615

1. The screw should be levelled with the insert. Press the bolt into the case so that the insert drops down and level with the case.
2. Push the coupling into the profile and release the press and the insert pops up into the punchhole. Tighten the coupling.

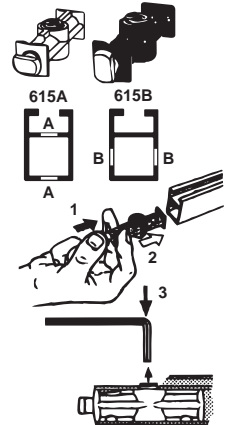

Standard finish of all profiles is natural anodized to 10 microns. Color anodized or powder coated available to special order. Profiles available in 5 meter stock lengths. All dimensions in mm. SUBJECT TO TECHNICAL ALTERATIONS

FOGA® SHIPPING CASES

FSU-SC-4925

(Front View)

(Back View)



FSU-SC-4030

(Front View)

(Back View)



FSU-SC-4131

(Front View)

(Back View)



| PART # | SIZE | WEIGHT |
|-------------|-----------------------|---------|
| FSU-SC-4925 | 49" x 25" x 9" I.D. | 34 lbs. |
| FSU-SC-4030 | 40¼" x 30¼" x 6" I.D. | 21 lbs. |
| FSU-SC-4131 | 41½" x 31½" x 8" I.D. | 32 lbs. |

Poly Shipping Case

Black

CUSTOM ORDER

FSU-SC-CU



GREAT IDEAS NEED ACCESSORIES!

Shown 1" Tubing with Cladding Fittings & Wide Variety of LED Lighting Options



SLIDING DOOR TRACK

Peel & Stick Adhesive

NOTE:
Rough Opening Less 7/8" = Door Size

1 Roller Per Running Foot Included

STYRENE TRACK W/ROLLERS & PEEL-N-STICK ADHESIVE

Colors Available
*BK - Black *SG - Silver Gray

Peel & Stick Adhesive Mount to AT Tubing on page 89

With Adhesive - Available in 4 & 8 Ft. Lengths

| PART # | LENGTH |
|----------|--------|
| MT38-A4* | 4 ft. |
| MT38-A8* | 8 ft. |

PLASTIC FINGER PULLS

With high quality pressure sensitive adhesive backing. No holes to drill. Peel off protective backing paper and apply directly to surface of glass.

- 170-BK (Black)
- 170-CL (Clear)



ALUMINUM FRAME DOOR

Create a door frame with 1" tubing on page 204

Connectors on pages 205-206, 209

Add a hinge to complete the door -

POLYPROPYLENE HINGE

BLACK OR WHITE
Screw Size Recommended #10 Countersunk (not included)

| PART # | COLOR |
|------------|-------|
| 200-200-WH | White |
| 200-200-BK | Black |

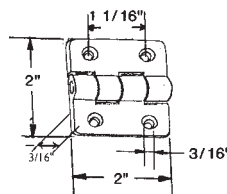

ALUMINUM FRAMING SYSTEM

AT TUBING & CONNECTOR SYSTEM

LET OUR SIMPLE CONCEPT FORM YOUR GREAT IDEA!

IDEAL FOR INDOOR & OUTDOOR USE!

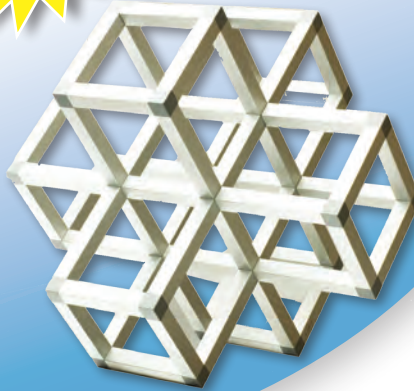

GREAT FOR:

- ★ TRADESHOWS
- ★ GREENHOUSES
- ★ MENUS
- ★ SIGNS



**We Can
Cut To Size -
Please Inquire**

1" Square Aluminum Tubing

Wall Thickness: .065"

Lengths: 8 Ft.

SQUARE TUBE

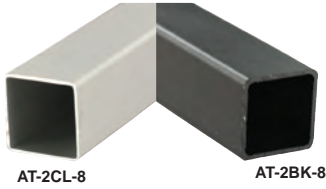

AT-2CL-8

AT-2BK-8

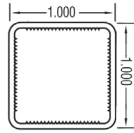

| PART # | FINISH |
|----------|----------------|
| AT-2CL-8 | Clear Anodized |
| AT-2BK-8 | Black Anodized |

5/8" FLANGE

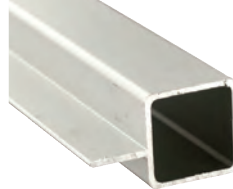

| PART # | FINISH |
|----------|----------------|
| AT-3CL-8 | Clear Anodized |
| AT-3BK-8 | Black Anodized |

SINGLE CHANNEL Fits 7/32" Panel

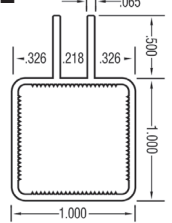
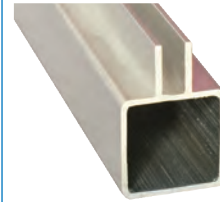

| PART # | FINISH |
|----------|----------------|
| AT-6CL-8 | Clear Anodized |
| AT-6BK-8 | Black Anodized |

5/8" 90° FLANGES

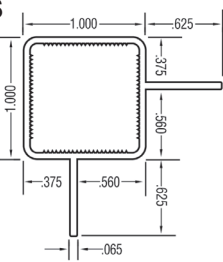
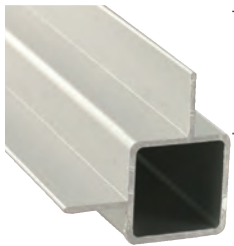

| PART # | FINISH |
|----------|----------------|
| AT-4CL-8 | Clear Anodized |
| AT-4BK-8 | Black Anodized |

5/8" 180° FLANGES

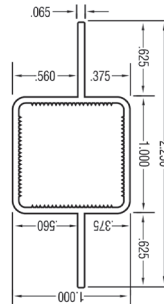
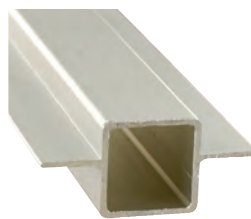

| PART # | FINISH |
|----------|----------------|
| AT-5CL-8 | Clear Anodized |
| AT-5BK-8 | Black Anodized |

Note: For All Tubing
Clear anodized finish is suitable for indoor and outdoor use.
Black for indoor only.

1" Square Aluminum Tubing

Wall Thickness: .044"

Lengths: 8 Ft.

DOUBLE CHANNEL 90° Fits 1/8" Panel

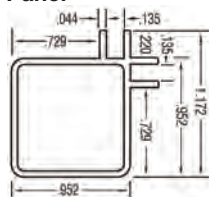
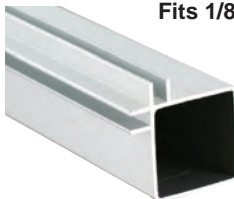

| PART # | FINISH |
|-----------|----------------|
| AT-14CL-8 | Clear Anodized |

SINGLE CHANNEL WITH 1/4" FLANGE Fits 1/8" Panel

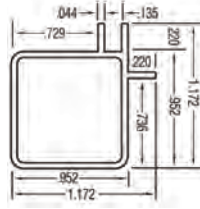
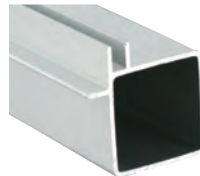

| PART # | FINISH |
|-----------|----------------|
| AT-15CL-8 | Clear Anodized |

SINGLE CHANNEL Fits 1/8" Panel

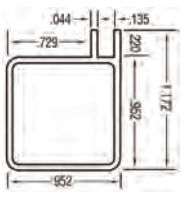
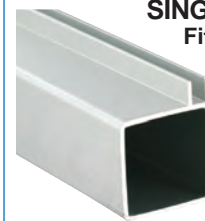

| PART # | FINISH |
|-----------|----------------|
| AT-17CL-8 | Clear Anodized |

SINGLE CHANNEL WITH 1/4" FLANGE Fits 1/4" Panel

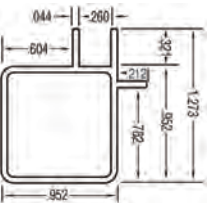
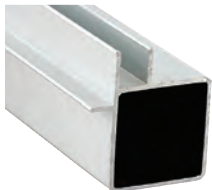

| PART # | FINISH |
|-----------|----------------|
| AT-16CL-8 | Clear Anodized |

SINGLE CHANNEL Fits 1/4" Panel

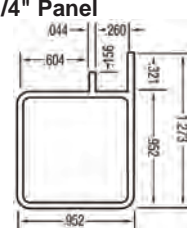
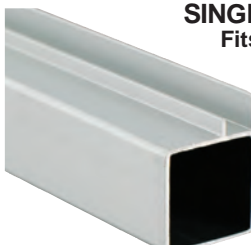

| PART # | FINISH |
|-----------|----------------|
| AT-18CL-8 | Clear Anodized |

1/4" FLANGE

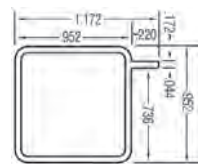

| PART # | FINISH |
|-----------|----------------|
| AT-19CL-8 | Clear Anodized |

ALUMINUM FRAMING SYSTEM

1" Tubing Connectors & Accessories

Material: Dupont™ Super Toughened Nylon
Available in Black or Grey

2WAY RIGHT ANGLE CONNECTOR



| PART # | COLOR |
|--------|-------|
| F521BK | Black |
| F521GY | Grey |

3WAY TEE CONNECTOR



| PART # | COLOR |
|--------|-------|
| F532BK | Black |
| F532GY | Grey |

** 3WAY CONNECTOR w/HEAVY DUTY CASTER SOCKET



****NOTE:** #F533C will accept a 3/8" diameter x 1" long friction fit caster stem (not included)
See Below for Caster

| PART # | COLOR |
|----------|-------|
| F533C/BK | Black |
| F533C/GY | Grey |

3WAY CORNER CONNECTOR

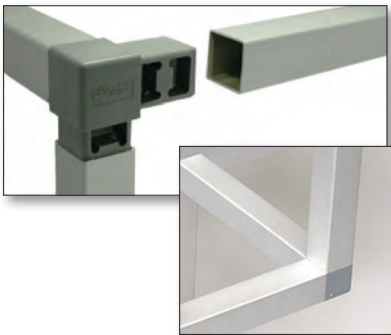

| PART # | COLOR |
|--------|-------|
| F533BK | Black |
| F533GY | Grey |

4WAY CROSS CONNECTOR



| PART # | COLOR |
|--------|-------|
| F544BK | Black |
| F544GY | Grey |

4WAY CONNECTOR



| PART # | COLOR |
|--------|-------|
| F545BK | Black |
| F545GY | Grey |

3WAY CONNECTOR w/2-3/8" DIA CASTER W/FRICTION RING STEM

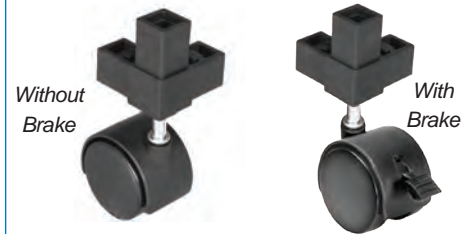

WITHOUT BRAKE

| PART # | COLOR |
|--------------|-------|
| F533C/BK-CST | Black |
| F533C/GY-CST | Grey |

WITH BRAKE

| PART # | COLOR |
|---------------|-------|
| F533C/BK-CSTB | Black |
| F533C/GY-CSTB | Grey |

5WAY CONNECTOR



| PART # | COLOR |
|--------|-------|
| F558BK | Black |
| F558GY | Grey |

6WAY CONNECTOR

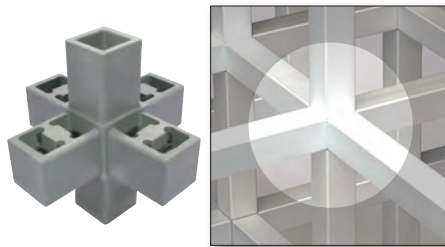

| PART # | COLOR |
|--------|-------|
| F568BK | Black |
| F568GY | Grey |

3WAY CONNECTOR w/LEVELER 1/4-20 x 1" LONG

1-3/8" Base Dia.
w/Thread Stem
& Insert



New

| PART # | COLOR |
|--------------|-------|
| F533C/BK-LEV | Black |
| F533C/GY-LEV | Grey |

ALUMINUM FRAMING SYSTEM

1" Tubing Connectors & Accessories

Material: Dupont™ Super Toughened Nylon
Available in Black or Grey

90° BASE CONNECTOR



PART # **COLOR**
F5323SPBK Black
F5323SPGY Grey

STRAIGHT BASE CONNECTOR



PART # **COLOR**
F5323BK Black
F5323GY Grey

PERPENDICULAR JOINER/SPLICER FOR 1" AT TUBING w/3/4" LONG SELF TAPPING SCREW

ALLOWS TO ATTACH ANY TUBING AT A PERPENDICULAR ANGLE!

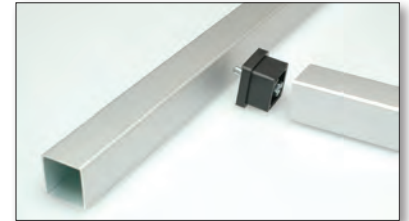

PART # **COLOR**
F5112MCBK Black
F5112MCGY Grey

THE INVISIBLE COUPLING

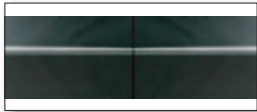
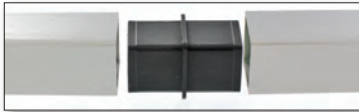
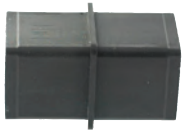

PART # **COLOR**
F5101BK Black
F5101GY Grey

STRAIGHT CONNECTOR



PART # **COLOR**
F500BK Black
F500GY Grey

STACK PLUG FOR USE WITH F533C CONNECTOR

GREAT FOR STACKING CASES!



PART # **COLOR**
F4PSPGY Grey

ALL METAL HEAVY DUTY SHELF REST for Glass or Wood Shelving



PART # **FINISH**
F514BK Black Anodized
F514CL Clear Anodized

END CAP



Material:
Low-Density Polyethylene

PART # **COLOR**
SHK-32S-BK Black

U-CLIP

4" LENGTHS

ALUMINUM MATERIAL - SATIN FINISH

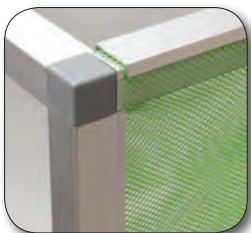

FMJ557-4-S

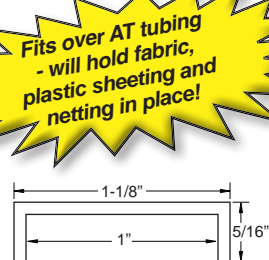

Fits over AT tubing - will hold fabric, plastic sheeting and netting in place!

CAVITY INSERT FOR 1" CONNECTOR LEGS

New

This accessory fits any 1" connector increasing surface area for a tighter fit



PART # **COLOR**
F007BK Black
F007GY Grey

ALUMINUM FRAMING SYSTEM

1-1/2" Heavy Duty Aluminum Tubing

Wall Thickness: 1/8"
Lengths: 8 Ft.

New

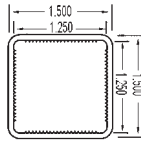
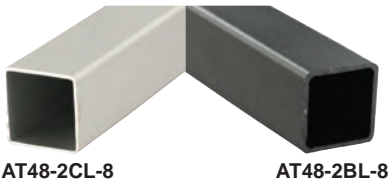

| PART # | FINISH |
|------------|----------------|
| AT48-2CL-8 | Clear Anodized |
| AT48-2BK-8 | Black Anodized |

Clear anodized finish is suitable for indoor and outdoor use. Black for indoor only.

1-1/2" Tubing Connectors & Accessories

Material: Dupont™ Super Toughened Nylon
Available in Black or Grey

Connectors fit any
1-1/2" O.D. Aluminum
or Steel Tubing with
1/8" wall thickness



**2 WAY
RIGHT ANGLE
CONNECTOR**

| PART # | FINISH |
|----------|--------|
| F48521BK | Black |
| F48521GY | Grey |



**3 WAY
CORNER
CONNECTOR**

| PART # | FINISH |
|----------|--------|
| F48533BK | Black |
| F48533GY | Grey |



**STRAIGHT
CONNECTOR**

| PART # | FINISH |
|----------|--------|
| F48500GY | Grey |
| F48500BK | Black |

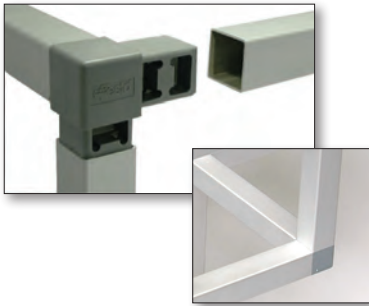

END CAP

Material:
Low-Density
Polyethylene

| PART # | FINISH |
|------------|--------|
| SHK-48S-BK | Black |



**PERPENDICULAR
JOINER/SPLICER
FOR AT TUBING 1-1/2"
WITH (4) LONG SELF
TAPPING SCREWS**

| PART # | FINISH |
|-------------|--------|
| F485112MCBK | Black |
| F485112MCGY | Grey |



COMING SOON!



**3 WAY TEE
CONNECTOR**

| PART # | FINISH |
|----------|--------|
| F48532BK | Black |
| F48532GY | Grey |



**4 WAY
CONNECTOR**

| PART # | FINISH |
|----------|--------|
| F48545BK | Black |
| F48545GY | Grey |

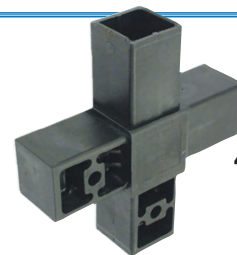

**4 WAY CROSS
CONNECTOR**

| PART # | FINISH |
|----------|--------|
| F48544BK | Black |
| F48544GY | Grey |



**5 WAY
CONNECTOR**

| PART # | FINISH |
|----------|--------|
| F48558BK | Black |
| F48558GY | Grey |

Hand tooling is not
completed on these items.
Hard samples are available for
prototype purposes only,
please inquire.



**6WAY
CONNECTOR**

| PART # | FINISH |
|----------|--------|
| F48568BK | Black |
| F48568GY | Grey |



ALUMINUM FRAMING SYSTEM

New

3/4" Square Aluminum Tubing

Lengths: 8 Ft.

SQUARE TUBE
Wall Thickness: .050

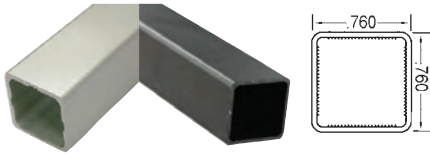

| PART # | FINISH |
|------------|----------------|
| AT24-2BK-8 | Black Anodized |
| AT24-2CL-8 | Clear Anodized |

3/8" FLANGE
Wall Thickness: .050

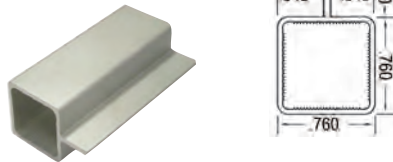

| PART # | FINISH |
|------------|----------------|
| AT24-3BK-8 | Black Anodized |
| AT24-3CL-8 | Clear Anodized |

3/8" 90° FLANGE
Wall Thickness: .050

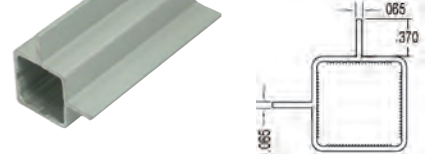

| PART # | FINISH |
|------------|----------------|
| AT24-4BK-8 | Black Anodized |
| AT24-4CL-8 | Clear Anodized |

Clear anodized finish is suitable for indoor and outdoor use. Black for indoor only.

3/4" Tubing Connectors & Accessories

Material: Dupont™ Super Toughened Nylon
Available in Black or Grey



2WAY RIGHT ANGLE CONNECTOR

| PART # | FINISH |
|----------|--------|
| F24521BK | Black |
| F24521GY | Grey |



3WAY TEE CONNECTOR

| PART # | FINISH |
|----------|--------|
| F24532BK | Black |
| F24532GY | Grey |

3WAY CORNER CONNECTOR



| PART # | FINISH |
|----------|--------|
| F24533BK | Black |
| F24533GY | Grey |

STRAIGHT BASE CONNECTOR



| PART # | FINISH |
|-----------|--------|
| F245323BK | Black |
| F245323GY | Grey |

4WAY CONNECTOR



| PART # | FINISH |
|----------|--------|
| F24545BK | Black |
| F24545GY | Grey |

STRAIGHT CONNECTOR



| PART # | FINISH |
|----------|--------|
| F24500BK | Black |
| F24500GY | Grey |

PERPENDICULAR JOINER/SPLICER FOR 3/4" AT TUBING
W/3/4" LONG SELF TAPPING SCREW

ALLOWS TO ATTACH ANY TUBING AT A PERPENDICULAR ANGLE

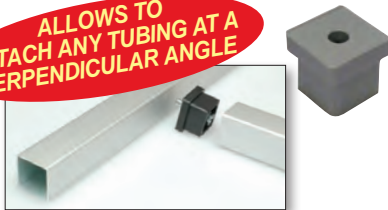

| PART # | FINISH |
|-------------|--------|
| F245112MCBK | Black |
| F245112MCGY | Grey |



END CAP

Material: Low-Density Polyethylene

| PART # | COLOR |
|------------|-------|
| DNW-S24-BK | Black |

4WAY CROSS CONNECTOR



| PART # | FINISH |
|----------|--------|
| F24544BK | Black |
| F24544GY | Grey |

CAVITY INSERT FOR 3/4" CONNECTOR LEGS

This accessory fits any 3/4" connector increasing surface area for a tighter fit



| PART # | FINISH |
|----------|--------|
| F24007BK | Black |
| F24007GY | Grey |

6WAY CONNECTOR



| PART # | FINISH |
|----------|--------|
| F24568BK | Black |
| F24568GY | Grey |

ALUMINUM FRAMING SYSTEM

1" Tubing Connectors & Accessories

New

**FITS 1" TUBE &
HOLDS 1/4" PANEL
CLADDING RIGID VINYL**

Available in Black or Clear
Material: PVC 12' lengths

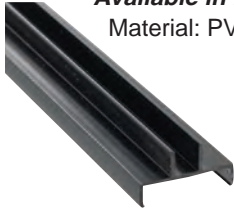

PART # FINISH

109-CL Clear
109-BK Black

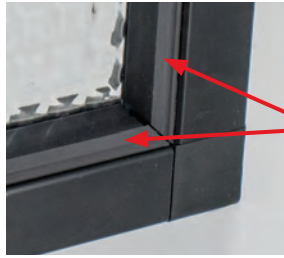

CASING TRIM



*All cast trim
sides can come
apart for easy
access to insert
or remove signage*



*Cast trim with
adhesive tape
is shown
attached to
our 1" tubing*

**CASING TRIM FOR
1/4" PANELS 1" BASE**

Available in Black or Nickel
With Adhesive Tape
Material: PVC 6' lengths

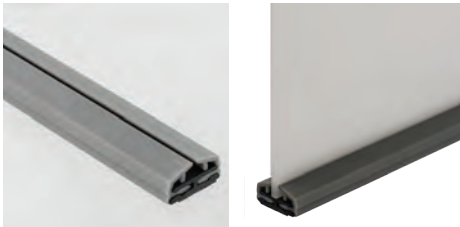

PART # FINISH

CT8NC Nickel
CT8BK Black

**CASING TRIM FOR
1/2" PANELS 1" BASE**

Available in Black or Nickel
With Adhesive Tape
Material: PVC 6' lengths

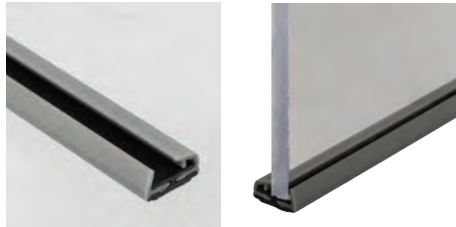

PART # FINISH

CT16NC Nickel
CT16BK Black

**CASING TRIM FOR
3/4" PANELS 1" BASE**

Available in Black or Nickel
With Adhesive Tape
Material: PVC 6' lengths



PART # FINISH

CT24NC Nickel
CT24BK Black

Material: Dupont™ Super Toughened Nylon
Available in Black or Grey

ADJUSTABLE 2WAY CONNECTOR

Material: PVC

15° Incremental locking from
90° to 180° for 1" Tubing



PART # FINISH

FJ22BK Black
FJ22GY Grey

**ADJUSTABLE TEE STYLE
CONNECTOR WITH
ROTATING BASE**

Vertical/Horizontal
For 1" Tubing

Material: PVC

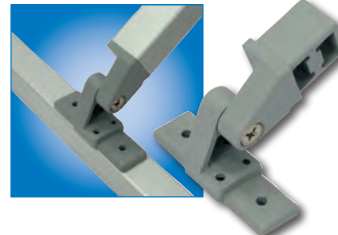

PART # FINISH

FJ32BK Black
FJ32GY Grey

**ADJUSTABLE 2WAY IN-LINE
BASE CONNECTOR**

For 1" tubing to connect
with another tube
at multiple angles

Material: PVC

PART # FINISH

FJ31BK Black
FJ31GY Grey



**ADJUSTABLE 2WAY
CONNECTOR
w/LOCKING NUT**

For 1" Tube

**CAPABLE OF
280° RADIUS**

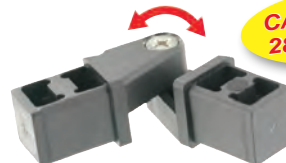

PART # COLOR

F52AJNBK Black
F52AJNGY Grey

Any Angle, Any Panel, Any Display



PRODUCT FEATURES:

- Join panels in thicknesses ranging from 1/8" to 3/4"!
- The Klem® connector makes it easy to create angles from 90° to 270°!
- Ideal for straight or curved walls, prisms, squares cubes, pyramids, domes or any type of display!
- Made of nickel plated zinc alloy and synthetic rubber inserts. The Klem® connector provides great strength and long term durability.
- Standard gap between panels
Mini = 1/2" Super = 3/4"
- To Close gap between panels, Notch the panels.
Mini = 1/4" x 15/16"
Super = 5/16" x 1-3/8"



MULTIPLE PANELS

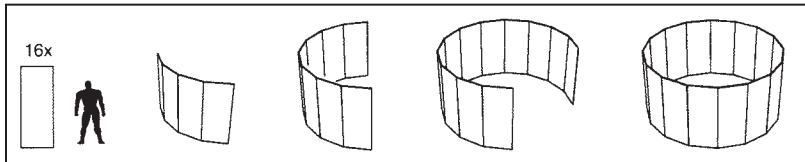

SHOWCASE

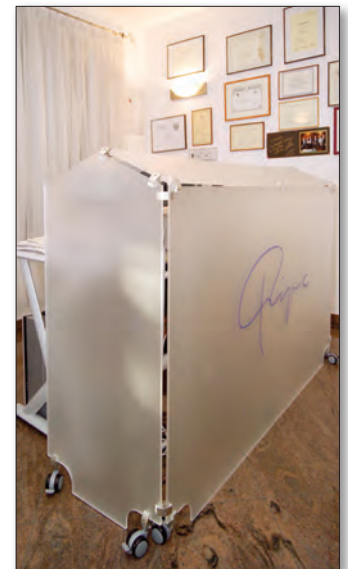

PARTITION



MUSEUMS & GALLERIES



BMW SHOWROOM IN AUSTRIA



TRADE SHOWS



ANY PANEL! ANY ANGLE! ANY DISPLAY!

MINI klem®

For panel thicknesses from 1/8" to 5/16"

PART #
7123M-*

* Please specify panel size

2 = 1/8", 4 = 3/16", 6 = 1/4", 8 = 5/16"

Example: for 1/4" panels, Part# is 7123M-6

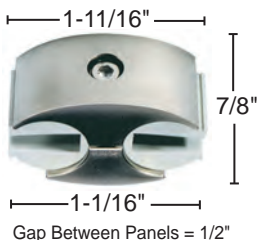

SUPER klem®

For panel thicknesses from 3/8" to 3/4"

PART #
7123S-*

* Please specify panel size

10 = 3/8", 12 = 1/2", 16 = 5/8", 19 = 3/4"

Example: for 1/2" panels, Part# is 7123S-12

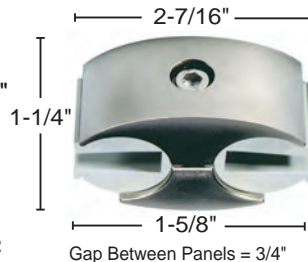

BODIES ONLY without inserts

MINI KLEM
7123M



Fits 3/4" Tubing

SUPER KLEM
7123S

Fits 1-1/8" Tubing

BODY WITH LEVELING FOOT

MINI KLEM
7123M-LF

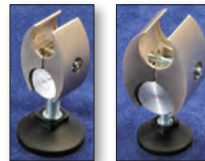

To be used with a single insert or tubing

SUPER KLEM
7123S-LF

INSERT PAIRS ONLY

MINI KLEM
0802PR = 1/8"
0804PR = 3/16"
0806PR = 1/4"
0808PR = 5/16"



SUPER KLEM
0210PR = 3/8"
0212PR = 1/2"
0216PR = 5/8"
0219PR = 3/4"

BODY WITH TWIN WHEEL CASTER w/BRAKE

MINI KLEM
7123M-CSTR



Caster Diameter is 2" - Load Rating = 75 lbs per caster
To be used with a single insert or tubing

SUPER KLEM
7123S-CSTR

SINGLE INSERTS ONLY

MINI KLEM
0802 = 1/8"
0804 = 3/16"
0806 = 1/4"
0808 = 5/16"



To be used when connecting panels

SUPER KLEM
0210 = 3/8"
0212 = 1/2"
0216 = 5/8"
0219 = 3/4"

BODY WITH WALL MOUNT

MINI KLEM
7123M-WM



To be used with a single insert or tubing

SUPER KLEM
7123S-WM

TUBING INSERTS ONLY

MINI KLEM
0713
1/2" ROUND TUBING



To be used when connecting tubes.

SUPER KLEM
0320
3/4" ROUND TUBING

HEX KEY

MINI KLEM
0160



SUPER KLEM
0170

NUTS AND BOLTS

MINI KLEM
7123M-NB



SUPER KLEM
7123S-NB

MANY CONNECTION OPTIONS!

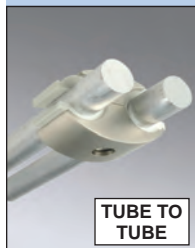

TUBE TO TUBE

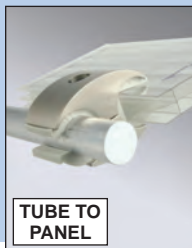

TUBE TO PANEL



3-WAY PANEL

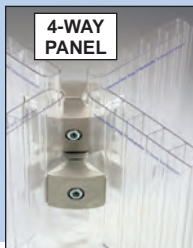

4-WAY PANEL



CASTER



LEVELING FOOT



WALL MOUNT

CLASSIC URN STANCHIONS

**WITH CRUSHED VELOUR
OR BRAIDED ROPE
GUIDANCE**

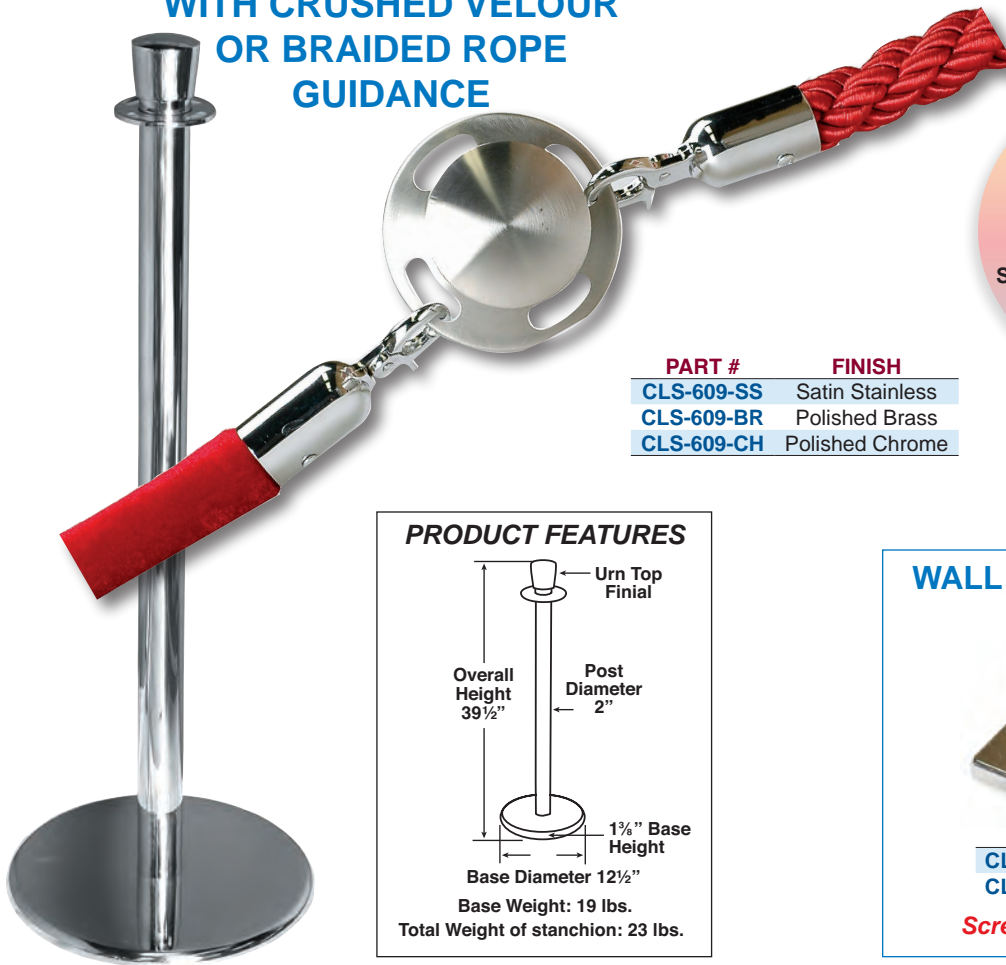

| PART # | FINISH |
|------------|-----------------|
| CLS-609-SS | Satin Stainless |
| CLS-609-BR | Polished Brass |
| CLS-609-CH | Polished Chrome |

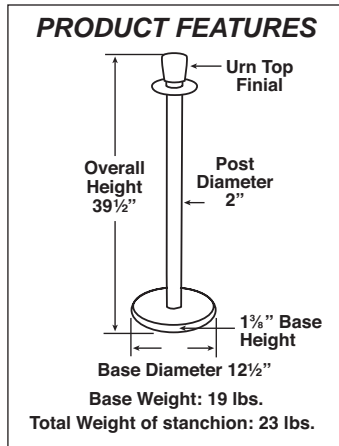
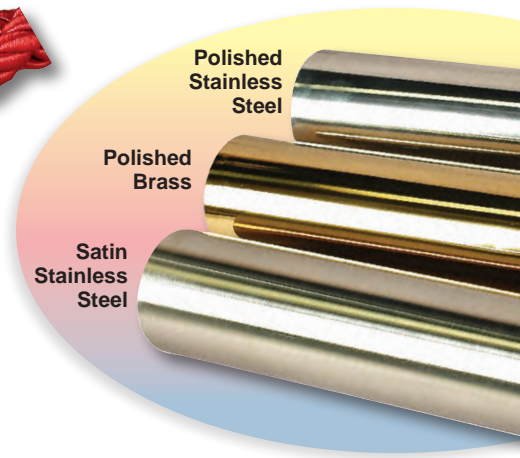

WALL PLATE

| PART # | FINISH |
|-----------|-----------------|
| CLS-WP-BR | Polished Brass |
| CLS-WP-CH | Polished Chrome |

Screws with Anchors Included

CRUSHED VELOUR



ROPES



BRAIDED



PREMIUM ROPES WITH WEIGHTED CHAIN

| PART # | STYLE | LENGTH |
|----------|--------|--------|
| CLS-RP4- | Velvet | 4 ft. |
| CLS-RP6- | Velvet | 6 ft. |

ECONOMY ROPES

| PART # | STYLE | LENGTH |
|------------|--------|--------|
| *CLS-RP6E- | Velvet | 6 ft. |

* Available in Black, Blue & Burgundy

| PART # | STYLE | LENGTH |
|-----------|---------|--------|
| CLS-BRD4- | Braided | 4 ft. |
| CLS-BRD6- | Braided | 6 ft. |

NOTE: Please add appropriate color code & finish code to part # when ordering.
(Example: CLS-RP4-BRG-BR = 4 ft. Velvet Rope, Burgundy with Brass Hooks)

RETRACT-IT II

Black Powder Coated or Chrome Plated Stanchions with Polyester Retractable Belt

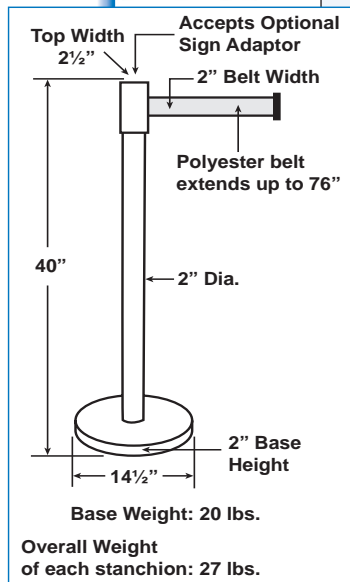
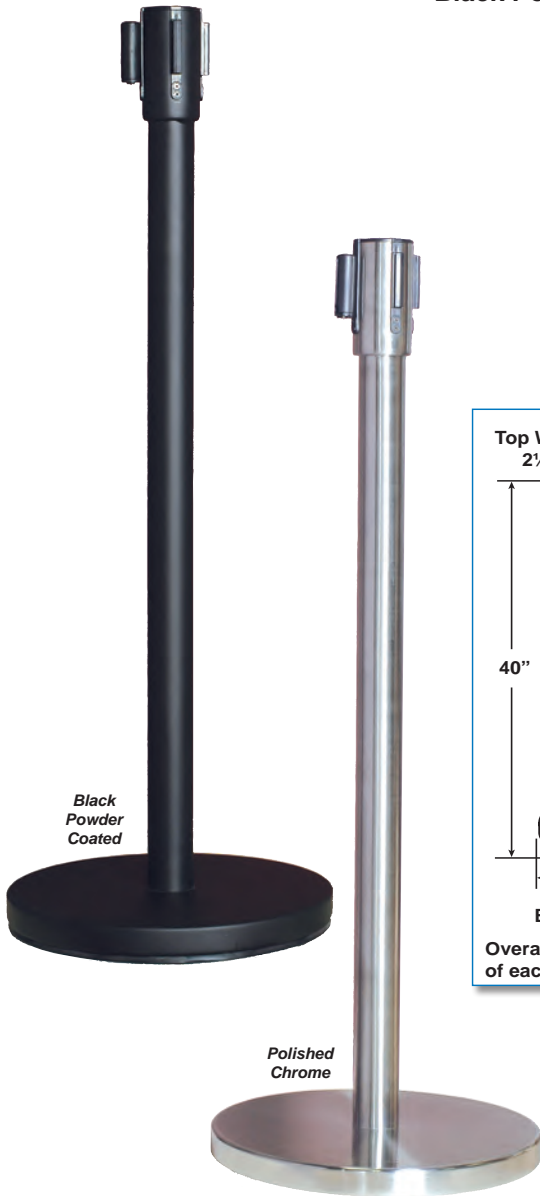

★ **PRODUCT FEATURES:**



★ **NON-MARRING RUBBERIZED FLOOR RING WITH A CORROSION RESISTANT GALVANIZED STEEL BASE**

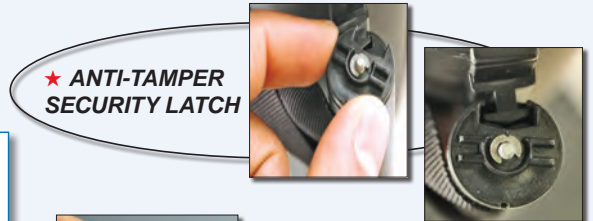

★ **ANTI-TAMPER SECURITY LATCH**



★ **BUILT-IN 4-WAY ADAPTOR EXPANDS YOUR CONFIGURATION POSSIBILITIES**

BONUS FEATURE

★ **WORKS WITH ALL MAJOR BRANDS OF STANCHIONS, ADD ON & SAVE!**

★ **SHIPS KNOCK DOWN IN A UPS SIZE CARTON!**

| PART# | POST FINISH | BELT COLOR |
|--------------|---------------------|------------|
| RCT2-BLK-BLK | Black Powder Coated | Black |
| RCT2-BLK-RED | Black Powder Coated | Red |
| RCT2-BLK-BLU | Black Powder Coated | Blue |
| RCT2-CHR-BLK | Polished Chrome | Black |
| RCT2-CHR-RED | Polished Chrome | Red |
| RCT2-CHR-BLU | Polished Chrome | Blue |

WALL MOUNT BELT

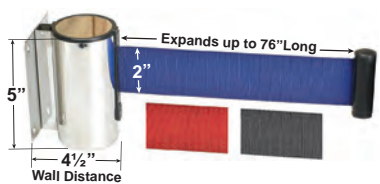

SET DOES NOT INCLUDE RCT2-PLATE

RCT2-WALL-*

*-(Red, Black & Blue)

WALL MOUNT PLATE

To be used w/ stanchions

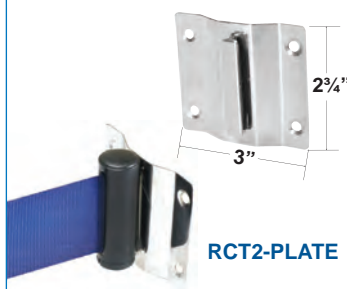

2-SIDED SIGN HOLDER

WORKS WITH RETRACT-IT II

Holds 8.5" x 11" sign with no-glare plastic protective plastic sheet



RCT2-SIGN

POP BOWL

WORKS WITH RETRACT-IT II



Perfect for impulse buy items

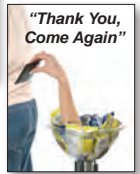

RCT2-BOWL

WOOD STANCHIONS

- Furniture Grade Quality
- Solid Red Oak with English Oak Stain
- Durable commercial grade finish
- Handcarved
- Pre-finished & sealed with a hand rubbed teak oil.
- Works with all standard ropes
- Exquisite Craftsmanship
- 72 Combinations
- Ships UPS
- Ropes attach at a 36 inch height



WS-223-BR
shown

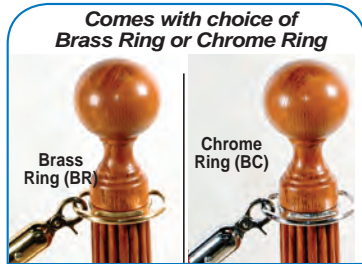

Comes with choice of
Brass Ring or Chrome Ring



Brass
Ring (BR)



Chrome
Ring (BC)

Ropes



Crushed
Velour

See page 212
for more
information
on ropes



Braided

SQUARE EGG AND DART BASE



WS-133-BR
WS-133-BC

Overall
Height: 41"
Weight:
14 lbs.



WS-223-BR
WS-223-BC

Overall
Height: 41"
Weight:
14 lbs.



WS-413-BR
WS-413-BC

Overall
Height: 39"
Weight:
14 lbs.

Material: Solid Red Oak
Stain: Medium English Oak
Base: 12" Square

WOOD STANCHIONS

PLAIN ROUND BASE



WS-132-BR
WS-132-BC

Overall
Height: 41"
Weight:
15 lbs.



WS-222-BR
WS-222-BC

Overall
Height: 41"
Weight:
15 lbs.

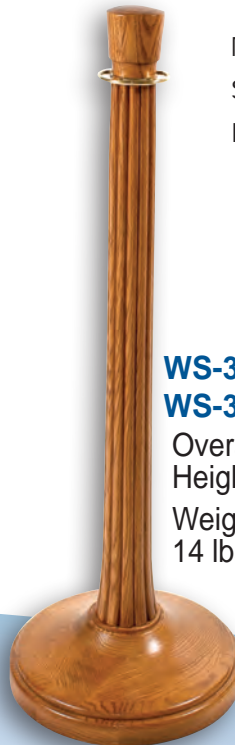

WS-312-BR
WS-312-BC

Overall
Height: 39"
Weight:
14 lbs.

Material: Solid Red Oak
Stain: Medium English Oak
Base: 13-3/4" Diameter

ROUND ACANTHUS LEAF BASE



WS-121-BR
WS-121-BC

Overall
Height: 41"
Weight:
15 lbs.



WS-211-BR
WS-211-BC

Overall
Height: 41"
Weight:
14 lbs.



WS-331-BR
WS-331-BC

Overall
Height: 39"
Weight:
15 lbs.

Material: Solid Red Oak
Stain: Medium English Oak
Base: 13-3/4" Diameter

PLASTIC & LIGHTED LED STANCHION ACCESSORIES

PLASTIC CHAINS



Available Colors

- All colors stocked in 33 ft. lengths (Polished Chrome stocked in 16 ft. lengths).
- Available in 3/4", 1", 1-1/2" and 2" links.
- Color chains must be purchased in full 33' lengths. (Polished Chrome must be purchased in 16 ft. lengths).
- **All plastic chains come bagged except for 2" chain which comes on a reel.**

GREAT FOR P.O.P. DISPLAYS

*Color Code=

- BL (Blue)
- RD (Red)
- PK (Pink)
- GR (Green)
- OR (Orange)
- WH (White)
- BK (Black)
- PC (Polished Chrome)
- YE (Yellow)

| PART # | SIZE |
|--------|--------|
| PC24-* | 3/4" |
| PC32-* | 1" |
| PC48-* | 1-1/2" |
| PC64-* | 2" |

POLISHED CHROME ONLY

| PART # | SIZE |
|---------|--------|
| PC32-PC | 1" |
| PC48-PC | 1-1/2" |
| PC64-PC | 2" |

Other colors available - please inquire

PLASTIC S-HOOKS

Colors available: White, Polished Chrome or Black

BLACK & WHITE
(COLOR CODE* BK=Black, WH=White)

| PART # | SIZE |
|--------|--------|
| SH32-* | 1" |
| SH48-* | 1-1/2" |
| SH64-* | 2" |

POLISHED CHROME

| PART # | SIZE |
|---------|--------|
| SH32-PC | 1" |
| SH48-PC | 1-1/2" |
| SH64-PC | 2" |



PLASTIC CONNECTING LINKS

Colors available: White, Polished Chrome or Black

BLACK & WHITE
(COLOR CODE* BK=Black, WH=White)

| PART # | SIZE |
|--------|--------|
| CL48-* | 1-1/2" |
| CL64-* | 2" |

POLISHED CHROME

| PART # | SIZE |
|---------|--------|
| CL48-PC | 1-1/2" |
| CL64-PC | 2" |



SPRING LOADED NYLON RETRACTABLE CONNECTING LINK



Colors available: Black or White

| PART # | COLOR |
|---------|-------|
| SNAP-BK | Black |
| SNAP-WH | White |

PLASTIC CLOTHES PIN



Colors available: Ivory
• Clothes pin attaches to plastic chain.

| PART # | COLOR |
|------------|-------|
| PC-HANGPIN | Ivory |

SIGNAGE ADAPTER

(ONLY WORKS WITH PLASTIC STANCHIONS)

Colors available: Black or White

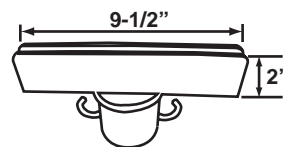

| PART # | COLOR |
|------------|-------|
| SN-SIGN-BK | Black |
| SN-SIGN-WH | White |

Works with 3/8"-5/8" Signage



PLASTIC STANCHIONS WITH BASE

“Crowd Control In A Box”

VALUE 4 PACK



* 33 feet of chain included.

PRODUCT FEATURES:

- **Kit Includes:** - 4 plastic stanchions (2-1/2" diameter x 40" high with 14" diameter base). **(3" diameter for polished chrome).**
- 1 c-hook assembly included with each stanchion.
- 33' x 1-1/2" plastic chain **(*32' in polished chrome).**
- Recommended maximum distance should not exceed 8' between stanchions.
- For added support, it is recommended that the base be filled with sand.

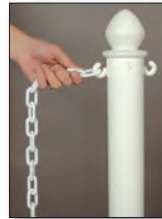
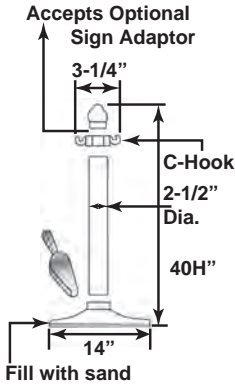

Plastic chain easily connects to c-hook assembly.

Remove cap to slip chain through or to connect the optional signage adaptor.



OPTIONAL SIGNAGE ADAPTER

See page 216 for more details on sign adaptor.

| PART # | COLOR |
|------------|-------|
| SN-SIGN-BK | Black |
| SN-SIGN-WH | White |

| PART # | COLOR |
|--------------|-------|
| SNB-40BK-KIT | Black |
| SNB-40WH-KIT | White |

| PART # | DESCRIPTION | COLOR |
|----------------|--------------------------------|-----------------|
| SNB-40PC-KIT | 4 Stanchions & 32 ft. of chain | Polished Chrome |
| SNB-40PC-KITNC | 4 Stanchions without chain | Polished Chrome |

PLASTIC STANCHIONS WITH BASE

Great For Most Control Needs!

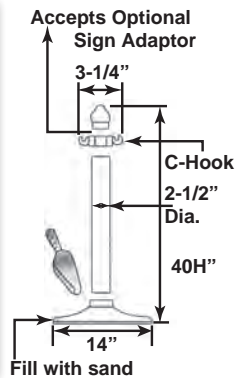

PRODUCT FEATURES:

- Recommended maximum distance should not exceed 8' between stanchions.
- For added support, it is recommended that the base be filled with sand.
- One C-hook assembly included with each stanchion.
- (C-Hook **NOT** removeable on SNB-40PC)

| PART # | COLOR | DESCRIPTION |
|----------|-----------------|-------------------|
| SNB-40BK | Black | 40"H x 2-1/2 Dia. |
| SNB-40WH | White | 40"H x 2-1/2 Dia. |
| SNB-40PC | Polished Chrome | 40"H x 3" Dia. |

Other colors available - please inquire

OPTIONAL SIGNAGE ADAPTER

See page 216 for more details on sign adaptor.

| PART # | COLOR |
|------------|-------|
| SN-SIGN-BK | Black |
| SN-SIGN-WH | White |

PLASTIC LANDSCAPE STANCHIONS WITH STAKE

Great For Outdoor Events, Landscapes & Gardens!

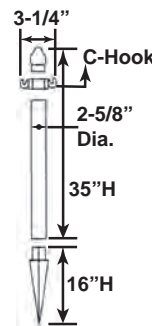

PRODUCT FEATURES:

- Recommended maximum distance should not exceed 8' between stanchions.
- One C-hook assembly included with each stanchion.

| PART # | COLOR | DESCRIPTION |
|----------|-------|---------------|
| SNS-40BK | Black | 35"H x 2-5/8" |
| SNS-40WH | White | 35"H x 2-5/8" |

Other colors available - please inquire

OPTIONAL SIGNAGE ADAPTER

See page 216 for more details on sign adaptor.

| PART # | COLOR |
|------------|-------|
| SN-SIGN-BK | Black |
| SN-SIGN-WH | White |

HEAVY DUTY PLASTIC STANCHIONS

Great For Construction Sites and Parking Lots!

STURDY!



PRODUCT FEATURES:

- Recommended maximum distance should not exceed 20' between stanchions.
- When the base is completely filled with water, the stanchion weight increases to 16 lbs., thus providing additional support.
- One C-hook assembly included with each stanchion.

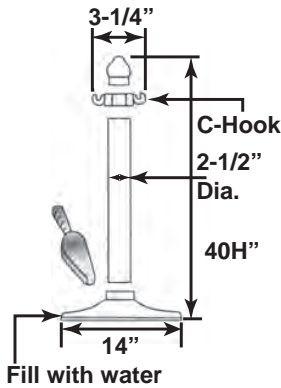

| PART # | DESCRIPTION |
|--------------|--|
| SNB-40HD | Yellow w/black stripes w/black base |
| SNB-40HD-KIT | 4 pcs. Yellow w/black stripes w/black base |

OPTIONAL SIGNAGE ADAPTER

See page 216 for more details on sign adaptor.

| PART # | COLOR |
|------------|-------|
| SN-SIGN-BK | Black |
| SN-SIGN-WH | White |

LIGHTED LED PLASTIC STANCHIONS

Great For Nightclubs! Parking Lots! Restaurants!



Portable Lighted Plastic Stanchion with red, green, blue LED light. Continuous or flashing option. Requires 1 x 9v battery, (*not included*) or can run off the **included** power Adaptor (AC in DC out). **Not for outdoor use when using AC/DC power adaptor.**

PRODUCT FEATURES:

- Recommended maximum distance should not exceed 8' between stanchions.
- One C-hook assembly included with each stanchion.

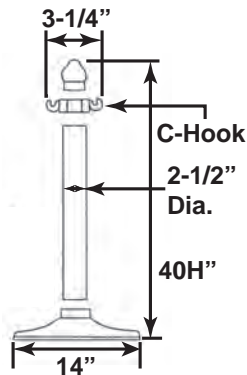

- Average light time 1-2 hours with 9V battery.
- Color: Red, Green, Blue Mix.
- 21 Diodes = 420 m.A (Amper) Ideal for Decoration & Caution areas.
- 4 Option Light Speed Control Switch (under cap finial).

| PART # |
|--------|
| SN-LED |

Each post is 40 inches high including the cap finial. The base is 14" in diameter, and the post is 2-1/2" in Diameter. Each LED post weighs 4 lbs.