

CABINETS, FURNITURE, DECORATIVE TRIMS & COMPONENTS

Pgs. 468-501



Wood Mouldings (Rope)



Wood Mouldings (Hardwood Chair Rail & Crown)



Wood Mouldings (Rope Accented)



Design a Column Systems



Wood Mouldings

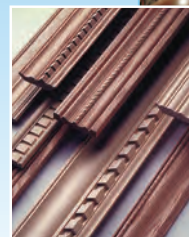

Range Hoods

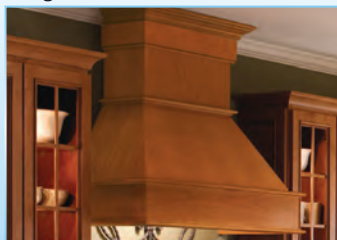

Wood Mouldings (Hand Carved Pierced)



Wood Mouldings (Hardwood)



Stemware Holder



Tambour

BOTTLE RACK	500	TAMBOUR		WOOD MOULDINGS	
DESIGN A COLUMN SYSTEMS		Appliance Garage Door Kits.....	499	<i>Decorative Mouldings</i>	
Caps.....	469	Door and Track Combo Kits.....	499	Hand Carved Pierced Mouldings.....	480
Center Spindles.....	470	Doors.....	496-497	Hardwood Chair Rail Mouldings.....	482
Ends.....	470	Spring Tension Track Kits.....	499	Hardwood Crown Mouldings.....	482
Half Round Columns.....	468	Track.....	498	Laser Carved Mouldings.....	479
Universal Caps/Bases.....	469	WINE RACK COLLECTION	501	Pressed Wood Mouldings.....	479
RANGE HOODS (Wood)	494-495	WINE RACK LATTICE	500	Rope Accented Base Mouldings.....	485
RANGE HOODS DUCTWORK KIT	495	WINE RING GROMMETS	501	Rope Accented Chair Rail Moulding.....	485
RANGE HOODS MANUAL VENTILATOR	495	WOOD MOULDINGS		Rope Accented Crown Mouldings.....	485
ROPE MOULDINGS (Half Round)		Beaded Mouldings.....	474	Rope Accented Shelf Edge Moulding4.....	85
Flexible Resin.....	473	Clear Poplar Baseboard Mouldings.....	490-493	Rope Mouldings (Half Round).....	472-473, 475-476
Polyurethane.....	473	Clear Poplar Casing Mouldings.....	490-491	Rope Ribbon Base Mouldings.....	484
Wood.....	472-473, 475-476	Clear Poplar Chair Rail Mouldings.....	490-493	Rope Ribbon Chair Rail Moulding.....	484
ROYAL WOOD COLLECTION CARVINGS		Clear Poplar Crown Mouldings.....	490-493	Rope Ribbon Crown Mouldings.....	484
Capitals.....	471	Corner Curve Mouldings.....	478	Rope Ribbon Shelf Edge Moulding.....	484
Filler Mouldings.....	471	Decorative Flat Mouldings.....	476	Squares Mouldings.....	477
Rosettes.....	471	<i>Decorative Mouldings</i>		Straight Cabinet Mouldings.....	478
STEMWARE COLLECTION	501	Egg & Dart Mouldings.....	475	Wood Plus Backband Mouldings.....	489
STEMWARE HOLDER	501	E-Z Red Half Round Mouldings.....	478	Wood Plus Casing Mouldings.....	489
STEMWARE RACK	500	Fluted Mouldings.....	474	Wood Plus Crown Mouldings.....	486-488
		Hand Carved Chair Rail Mouldings.....	481, 483	Wood Plus Frieze Mouldings.....	489
		Hand Carved Crown Mouldings.....	481, 483	Wood Plus Panel Mouldings.....	489

SEE PAGES 1007-1023 FOR A - Z INDEX

SOLID NORTH AMERICAN HARDWOOD HALF ROUNDS, CAPS & BASES

DESIGN A COLUMN is a cost effective way to create mix and match components to your own designs. Easily pair one of our half rounds with a cap or base of your choice to enhance the perfect look on all your projects. The possibilities are endless!

CHERRY - 4 ft. lengths
MAPLE - 8 ft. lengths

1 1/2" Half Round Column Styles

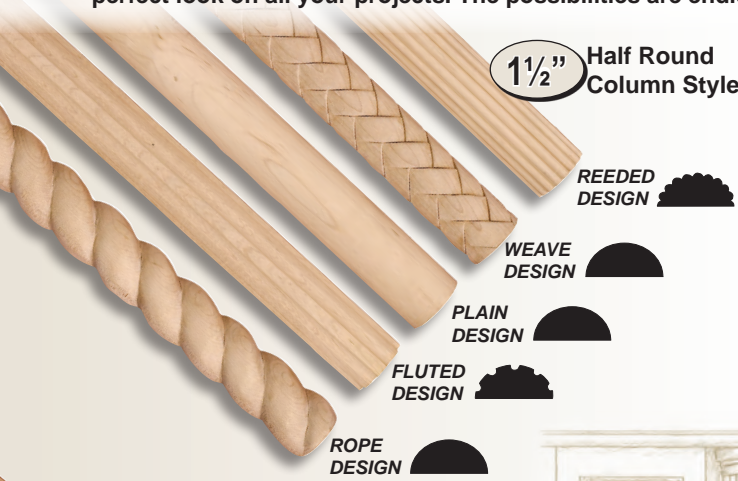

REEDED DESIGN 

WEAVE DESIGN 

PLAIN DESIGN 

FLUTED DESIGN 

ROPE DESIGN 

- Material: North American Hard Maple or Cherry Woods.
- No Sanding - Ready To Finish.
- Stain or Paint.
- Applications: Cabinetry, Islands, Furniture, etc...

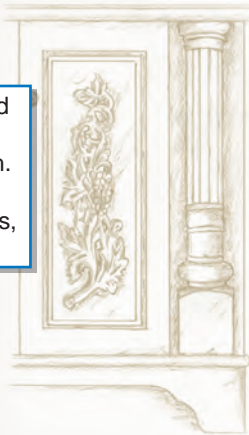

2 1/2" Half Round Column Styles

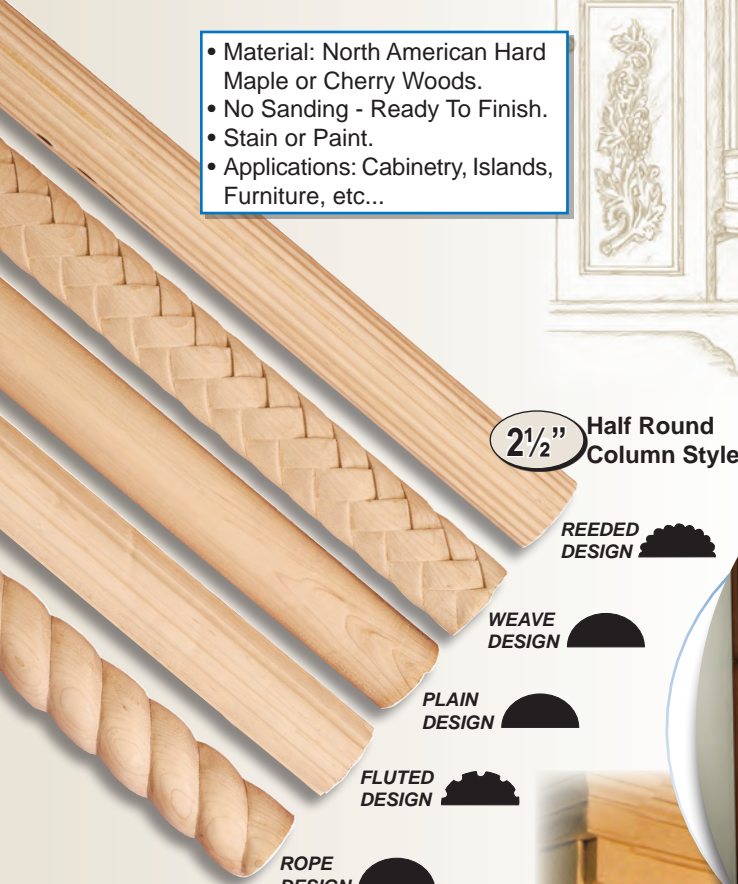

REEDED DESIGN 

WEAVE DESIGN 

PLAIN DESIGN 

FLUTED DESIGN 

ROPE DESIGN 

ROPE Half Round Columns

PART #	FINISH	SIZE
JB-150-RM	MAPLE	3/4" TH x 1-1/2" W x 8' L
JB-150-RCH	CHERRY	3/4" TH x 1-1/2" W x 4' L
JB-250-RM	MAPLE	1-1/8" TH x 2-1/2" W x 8' L
JB-250-RCH	CHERRY	1-1/8" TH x 2-1/2" W x 4' L

FLUTED Half Round Columns

PART #	FINISH	SIZE
JB-150-FM	MAPLE	3/4" TH x 1-1/2" W x 8' L
JB-150-FCH	CHERRY	3/4" TH x 1-1/2" W x 4' L
JB-250-FM	MAPLE	1-1/8" TH x 2-1/2" W x 8' L
JB-250-FCH	CHERRY	1-1/8" TH x 2-1/2" W x 4' L

PLAIN Half Round Columns

PART #	FINISH	SIZE
JB-150-PM	MAPLE	3/4" TH x 1-1/2" W x 8' L
JB-150-PCH	CHERRY	3/4" TH x 1-1/2" W x 4' L
JB-250-PM	MAPLE	1-1/8" TH x 2-1/2" W x 8' L
JB-250-PCH	CHERRY	1-1/8" TH x 2-1/2" W x 4' L

WEAVE Half Round Columns

PART #	FINISH	SIZE
JB-150-WM	MAPLE	3/4" TH x 1-1/2" W x 8' L
JB-150-WCH	CHERRY	3/4" TH x 1-1/2" W x 4' L
JB-250-WM	MAPLE	1-1/8" TH x 2-1/2" W x 8' L
JB-250-WCH	CHERRY	1-1/8" TH x 2-1/2" W x 4' L

REEDED Half Round Columns

PART #	FINISH	SIZE
JB-150-REM	MAPLE	3/4" TH x 1-1/2" W x 8' L
JB-150-RECH	CHERRY	3/4" TH x 1-1/2" W x 4' L
JB-250-REM	MAPLE	1-1/8" TH x 2-1/2" W x 8' L
JB-250-RECH	CHERRY	1-1/8" TH x 2-1/2" W x 4' L



Photo courtesy of Rev-A-Shelf

SOLID NORTH AMERICAN HARDWOOD HALF ROUNDS, CAPS & BASES

CHERRY - 4 ft. lengths
MAPLE - 8 ft. lengths

UNIVERSAL CAPS OR BASES



**UNIVERSAL
WEAVED
ROUND
CAP OR
BASE**

- A** For 1-1/2" Half Round
2-7/8" H x 2-1/2" W x 1-1/4" Depth
- B** For 2-1/2" Half Round
4-3/8" H x 3-7/8" W x 1-7/8" Depth

	PART #	FINISH
A	JB-WRCB150-M	Maple
	JB-WRCB150-CH	Cherry
B	JB-WRCB250-M	Maple
	JB-WRCB250-CH	Cherry



**PLAIN
ROUND
UNIVERSAL
CAP OR
BASE**

- A** For 1-1/2" Half Round
2-7/8" H x 2-1/2" W x 1-1/4" Depth
- B** For 2-1/2" Half Round
4-3/8" H x 3-7/8" W x 1-7/8" Depth

	PART #	FINISH
A	JB-PRCB150-M	Maple
	JB-PRCB150-CH	Cherry
B	JB-PRCB250-M	Maple
	JB-PRCB250-CH	Cherry



**UNIVERSAL
CAP OR
BASE**

- A** For 1-1/2" Half Round,
1-1/4" H x 2-7/8" W x 1-3/8" Depth
- B** For 2-1/2" Half Round,
2-1/8" H x 4-1/8" W x 2" Depth

	PART #	FINISH
A	JB-CB150-M	Maple
	JB-CB150-CH	Cherry
B	JB-CB250-M	Maple
	JB-CB250-CH	Cherry



**REEDED
UNIVERSAL
CAP OR
BASE**

- A** For 1-1/2" Half Round
3-1/2" H x 2-5/8" W x 1-1/4" Depth
- B** For 2-1/2" Half Round
5-3/8" H x 4" W x 2" Depth

	PART #	FINISH
A	JB-RECB150-M	Maple
	JB-RECB150-CH	Cherry
B	JB-RECB250-M	Maple
	JB-RECB250-CH	Cherry



**WEAVED
UNIVERSAL
CAP OR
BASE**

- A** For 1-1/2" Half Round
3-1/2" H x 2-5/8" W x 1-1/4" Depth
- B** For 2-1/2" Half Round
5-3/8" H x 4" W x 2" Depth

	PART #	FINISH
A	JB-WCB150-M	Maple
	JB-WCB150-CH	Cherry
B	JB-WCB250-M	Maple
	JB-WCB250-CH	Cherry



**PLAIN
UNIVERSAL
CAP OR
BASE**

- A** For 1-1/2" Half Round
3-1/2" H x 2-5/8" W x 1-1/4" Depth
- B** For 2-1/2" Half Round
5-3/8" H x 4" W x 2" Depth

	PART #	FINISH
A	JB-PCB150-M	Maple
	JB-PCB150-CH	Cherry
B	JB-PCB250-M	Maple
	JB-PCB250-CH	Cherry

CAPS

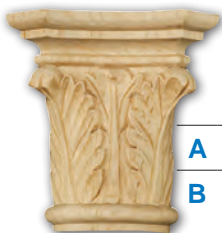

**DECORATIVE
CAP**

- A** For 1-1/2" Half Round
3-5/8" H x 3-3/8" W x 1-1/2" Depth
- B** For 2-1/2" Half Round
5-1/8" H x 5-1/8" W x 2-1/8" Depth

	PART #	FINISH
A	JB-DC150-M	Maple
	JB-DC150-CH	Cherry
B	JB-DC250-M	Maple
	JB-DC250-CH	Cherry



**CARVED
CAP**

- A** For 1-1/2" Half Round,
1-1/4" H x 2-7/8" W x 1-3/8" Depth
- B** For 2-1/2" Half Round,
2-1/8" H x 4-1/8" W x 2" Depth

	PART #	FINISH
A	JB-CC150-M	Maple
	JB-CC150-CH	Cherry
B	JB-CC250-M	Maple
	JB-CC250-CH	Cherry



SOLID NORTH AMERICAN HARDWOOD HALF ROUNDS, CAPS & BASES

CHERRY - 4 ft. lengths
MAPLE - 8 ft. lengths

CENTER SPINDLES



**WEAVE
CENTER
SPINDLE**

- A** For 1-1/2" Half Round
2-3/4" H x 2-1/4" W x 1-1/8" Depth
- B** For 2-1/2" Half Round
4-1/4" H x 3-1/2" W x 1-5/8" Depth

	PART #	FINISH
A	JB-WCS150-M	Maple
	JB-WCS150-CH	Cherry
B	JB-WCS250-M	Maple
	JB-WCS250-CH	Cherry



**REEDED
CENTER
SPINDLE**

- A** For 1-1/2" Half Round
2-3/4" H x 2-1/4" W x 1-1/8" Depth
- B** For 2-1/2" Half Round
4-1/4" H x 3-1/2" W x 1-5/8" Depth

	PART #	FINISH
A	JB-RECS150-M	Maple
	JB-RECS150-CH	Cherry
B	JB-RECS250-M	Maple
	JB-RECS250-CH	Cherry



**PLAIN
CENTER
SPINDLE**

- A** For 1-1/2" Half Round
2-3/4" H x 2-1/4" W x 1-1/8" Depth
- B** For 2-1/2" Half Round
4-1/4" H x 3-1/2" W x 2" Depth

	PART #	FINISH
A	JB-PCS150-M	Maple
	JB-PCS150-CH	Cherry
B	JB-PCS250-M	Maple
	JB-PCS250-CH	Cherry



**BACK
VIEW OF
COLUMN
AND
SPINDLE**



**DECORATIVE
CENTER
SPINDLE**

- A** For 1-1/2" Half Round
1-3/4" H x 2" W x 1" Depth
- B** For 2-1/2" Half Round
2-3/4" H x 3-1/8" W x 1-1/2" Depth

	PART #	FINISH
A	JB-DCS150-M	Maple
	JB-DCS150-CH	Cherry
B	JB-DCS250-M	Maple
	JB-DCS250-CH	Cherry



**CENTER
SPINDLE**

- A** For 1-1/2" Half Round,
1-1/2" H x 2-1/2" W x 1-1/4" Depth
- B** For 2-1/2" Half Round,
2-1/4" H x 4-1/8" W x 2" Depth

	PART #	FINISH
A	JB-CS150-M	Maple
	JB-CS150-CH	Cherry
B	JB-CS250-M	Maple
	JB-CS250-CH	Cherry



**CARVED
CENTER
SPINDLE**

- A** For 1-1/2" Half Round,
1-1/2" H x 2-1/2" W x 1-1/4" Depth
- B** For 2-1/2" Half Round,
2-1/4" H x 4-1/8" W x 2" Depth

	PART #	FINISH
A	JB-CCS150-M	Maple
	JB-CCS150-CH	Cherry
B	JB-CCS250-M	Maple
	JB-CCS250-CH	Cherry

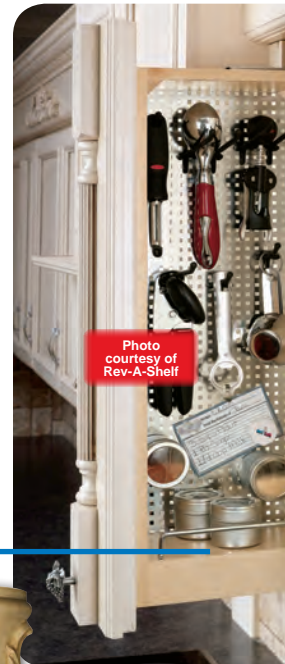

Photo courtesy of Rev-A-Shelf

ENDS



**REEDED
END BLOCK**

- A** For 1-1/2" Half Round
6-5/8" H x 2-5/8" W x 1-1/4" Depth
- B** For 2-1/2" Half Round
9-7/8" H x 4" W x 2" Depth

	PART #	FINISH
A	JB-REB150-M	Maple
	JB-REB150-CH	Cherry
B	JB-REB250-M	Maple
	JB-REB250-CH	Cherry



**PLAIN
END BLOCK**

- A** For 1-1/2" Half Round,
6-5/8" H x 2-5/8" W x 1-1/4" Depth
- B** For 2-1/2" Half Round,
9-7/8" H x 4" W x 2" Depth

	PART #	FINISH
A	JB-EB150-M	Maple
	JB-EB150-CH	Cherry
B	JB-EB250-M	Maple
	JB-EB250-CH	Cherry



**CARVED
END BASE**

- A** For 1-1/2" Half Round,
3-5/8" H x 2-1/4" W x 1-1/8" Depth
- B** For 2-1/2" Half Round,
5" H x 3-1/8" W x 1-1/2" Depth

	PART #	FINISH
A	JB-ECB150-M	Maple
	JB-ECB150-CH	Cherry
B	JB-ECB250-M	Maple
	JB-ECB250-CH	Cherry

ROYAL WOOD COLLECTION

These ornaments are made of North American Hard Maple, Red Oak, Cherry & Alder.

ROSETTES

3/4" x 2-3/4" x 2-3/4"



ADM801-PG

ADM801-RO

ADM801-MP

7/8" x 3-1/2" x 3-1/2"



ADM850-PG

ADM850-RO

ADM850-MP

7/8" x 4-1/2" x 4-1/2"



ADM803-PG

ADM803-RO

ADM803-MP

FILLER MOULDINGS

• 8 Ft. Lengths
• Two Sided, one Fluted, one Beaded
Accommodates 2 sizes - 2-3/4" and 3-3/4" Collars

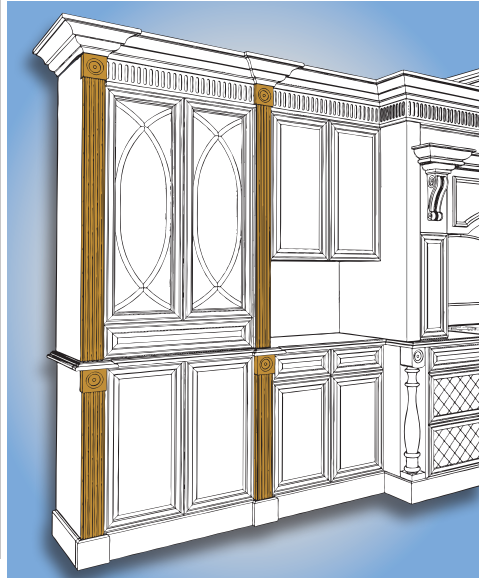

2-3/4" Collars

13/16" x 2-1/4", no design repeat
ADM149-POP
ADM149-RO
ADM149-MP

3-3/4" Collars

13/16" x 3-1/4", no design repeat
ADM150-POP
ADM150-RO
ADM150-MP

(Fluted)



(Beaded)



CAPITALS

RWC119-S (Hard Maple)
RWC119-S-OAK (Red Oak)
RWC119-S-CH (Cherry)
RWC119-S-ALD (Alder)
4" H x 3-7/8" W x 1" Depth
2-3/4" Collar



RWC119-M (Hard Maple)
RWC119-M-OAK (Red Oak)
RWC119-M-CH (Cherry)
RWC119-M-ALD (Alder)
5-3/8" H x 5-1/4" W x 1-1/8" Depth
3-3/4" Collar

* RWC119-L (Hard Maple)
* RWC119-L-OAK (Red Oak)
* RWC119-L-CH (Cherry)
* RWC119-L-ALD (Alder)
6-1/4" H x 6-1/8" W x 1-1/4" Depth

* RWC119-XL (Hard Maple)
* RWC119-XL-OAK (Red Oak)
* RWC119-XL-CH (Cherry)
* RWC119-XL-ALD (Alder)
8-1/8" H x 8-1/8" W x 1-5/8" Depth



RWC122-S (Hard Maple)
RWC122-S-OAK (Red Oak)
RWC122-S-CH (Cherry)
3-3/8" H x 4-1/8" W x 1-3/8" Depth
2-3/4" Collar

RWC122-L (Hard Maple)
RWC122-L-OAK (Red Oak)
RWC122-L-CH (Cherry)
4-3/4" H x 5-5/8" W x 1-3/4" Depth
3-3/4" Collar



RWC116-S (Hard Maple)
RWC116-S-OAK (Red Oak)
RWC116-S-CH (Cherry)
3" H x 6-7/8" W x 1-5/8" Depth
2-3/4" Collar

RWC116-M (Hard Maple)
RWC116-M-OAK (Red Oak)
RWC116-M-CH (Cherry)
4" H x 9-1/4" W x 2" Depth
3-3/4" Collar

* RWC116-L (Hard Maple)
* RWC116-L-OAK (Red Oak)
* RWC116-L-CH (Cherry)
4-5/8" H x 10-3/8" W x 2-3/8" Depth



RWC113-S (Hard Maple)
RWC113-S-OAK (Red Oak)
RWC113-S-CH (Cherry)
RWC113-S-ALD (Alder)
5-1/2" H x 3-1/4" W x 1" Depth
2-3/4" Collar

RWC113-L (Hard Maple)
RWC113-L-OAK (Red Oak)
RWC113-L-CH (Cherry)
RWC113-L-ALD (Alder)
7-1/2" H x 4-1/2" W x 1-1/4" Depth
3-3/4" Collar

RWC119
applique with
ADM150
filler moulding
(fluted side
shown)



RWC119
applique with
ADM149
filler moulding
(beaded side
shown)

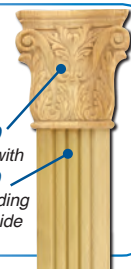

(Measurements are approximate)

* These items do not accommodate filler mouldings.

PREMIUM HALF ROUND ACCENT ROPE MOULDINGS

Sizes:
1-1/2", 2-1/2", 3" & 4"

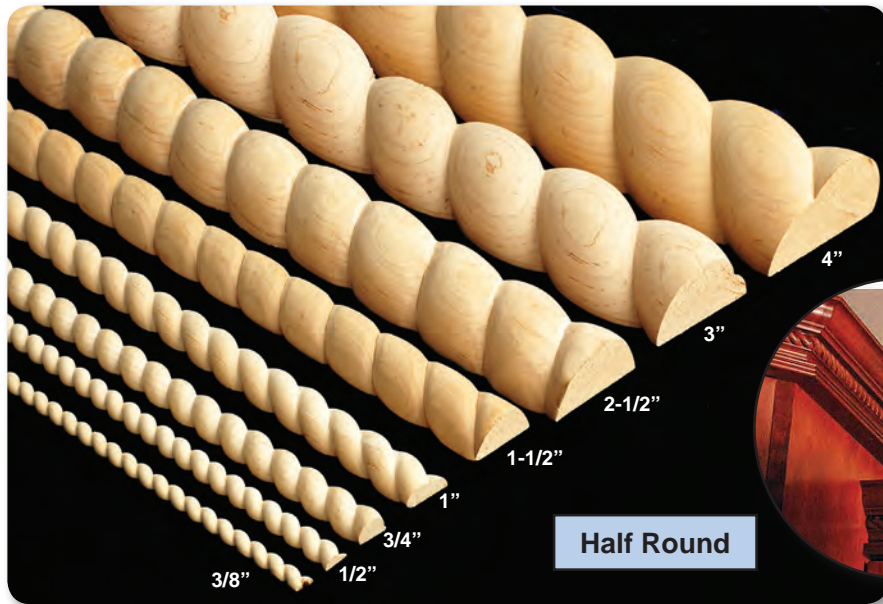

Right twist, 8 ft. lengths, 3/8", 1/2", 3/4", 1", 1-1/2", 2-1/2", 3", and 4" diameters in Hard Maple, Poplar, Red Oak & Cherry.
Left twist are only stocked in 3/8", 1/2", and 3/4" diameters in Maple & Poplar.
Other species and sizes are available, please inquire.

Half Round



AVAILABLE WOOD SPECIES:
Poplar (POP), Cherry (CH),
Red Oak (OAK), Hard Maple (MP)

NOTE: Additional sizes available upon request.

PART #	WIDTH
ROPE-375-OAK	3/8"
ROPE-500-OAK	1/2"
ROPE-750-OAK	3/4"
ROPE-100-OAK	1"
ROPE-150-OAK	1-1/2"
ROPE-250-OAK	2-1/2"
ROPE-300-OAK	3"
ROPE-400-OAK	4"
*ROPE-375-MP	3/8"
*ROPE-500-MP	1/2"
*ROPE-750-MP	3/4"
ROPE-100-MP	1"
ROPE-150-MP	1-1/2"
ROPE-250-MP	2-1/2"
ROPE-300-MP	3"
ROPE-400-MP	4"

PART #	WIDTH
ROPE-375-CH	3/8"
ROPE-500-CH	1/2"
ROPE-750-CH	3/4"
ROPE-100-CH	1"
ROPE-150-CH	1-1/2"
ROPE-250-CH	2-1/2"
ROPE-300-CH	3"
ROPE-400-CH	4"
*ROPE-375-POP	3/8"
*ROPE-500-POP	1/2"
*ROPE-750-POP	3/4"
ROPE-100-POP	1"
ROPE-150-POP	1-1/2"
ROPE-250-POP	2-1/2"
ROPE-300-POP	3"
ROPE-400-POP	4"

*** Left twist now available. Add prefix code to the end of each part number when ordering (ex: ROPE-500-MP-L). Please inquire on left twist for any additional sizes you may need.**

These beautifully designed rope accent mouldings can easily be stained and/or painted and can simply be tacked on to use for borders on cabinets, counters, furniture, doors, windows and much, much more.

PREMIUM ACCENT ROPE MOULDINGS



AVAILABLE WOOD SPECIES:
 Poplar (POP),
 Cherry (CH),
 Red Oak (OAK),
 Hard Maple (MP)

PART #	WIDTH
ROPE-375-OAK-R	3/8"
ROPE-500-OAK-R	1/2"
ROPE-750-OAK-R	3/4"
ROPE-375-MP-R	3/8"
ROPE-500-MP-R	1/2"
ROPE-750-MP-R	3/4"
ROPE-375-CH-R	3/8"
ROPE-500-CH-R	1/2"
ROPE-750-CH-R	3/4"
ROPE-375-POP-R	3/8"
ROPE-500-POP-R	1/2"
ROPE-750-POP-R	3/4"

NOTE: Additional sizes and larger quantity discounts available upon request.
 (RIGHT TWIST ONLY)

These beautifully designed rope accent mouldings can easily be stained and/or painted and can simply be tacked on to use for borders on cabinets, counters, furniture, doors, windows and much, much more.

Other sizes available, please inquire

FLEXIBLE HALF ROUND RESIN ROPE MOULDINGS

These mouldings are available in 6-12 ft. lengths.
 (Can Be Purchased In Minimum 6 Ft. - 12 Ft. Maximum Increments)



PART #	SIZE
DE-903	1" W x 3/8" Thick
DE-904	5/8" W x 1/4" Thick
DE-905	1/2" W x 1/4" Thick

POLYURETHANE ROPE MOULDINGS

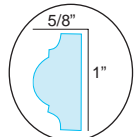

Max Radius 8"
 Design Repeat: 7/8"

Must be purchased in full length pieces

WOOD MOULDINGS

Our mouldings are made from the finest hardwoods and can be beautifully stained or painted to match any decor.

Used as a decorative accent on doors, cabinets, walls, ceilings, furniture, etc.



BEADED MOULDINGS

OWM-1700



Maple Veneer
3/8" Width
3/16" Thickness
4 Ft. Lengths



OWM-1701



Poplar
3/8" Width
3/16" Thickness
2 Ft. Lengths



OWM-1703

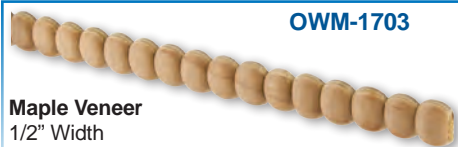

Maple Veneer
1/2" Width
3/16" Thickness
4 Ft. Lengths



OWM-1704



Maple
5/16" Width
5/16" Thickness
2 Ft. Lengths



OWM-1702



Maple
5/8" Width
5/16" Thickness
4 Ft. Lengths



ADM360-POP



Poplar
5/8" Width
3/8" Thickness
1-9/16" design repeat
8 Ft. Lengths



OWM-1730



Maple
15/16" Width
5/16" Thickness
8 Ft. Lengths



OWM-1461



Maple
3/4" Width
3/8" Thickness
8 Ft. Lengths



FLUTED MOULDINGS

OWM-1718



Maple
2" Width
1/4" Thickness
4 Ft. Lengths



OWM-1724

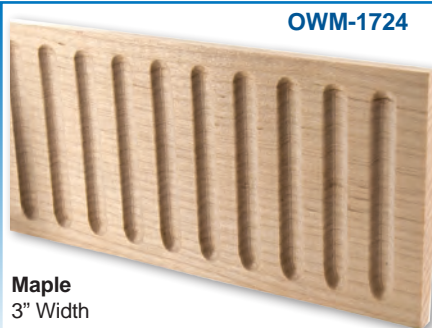

Maple
3" Width
1/4" Thickness
4 Ft. Lengths



WOOD MOULDINGS

EGG & DART MOULDINGS

ADM361-POP



Poplar
1/2" Width
3/8" Thickness
7/16" design repeat
8 Ft. Lengths



OWM-1433



Maple
5/8" Width
5/16" Thickness
8 Ft. Lengths



OWM-1420



Maple
5/8" Width
1/2" Thickness
8 Ft. Lengths



OWM-1470



Maple
3/4" Width
Thickness 1/2"
8 Ft. Lengths



OWM-1713



Maple
1" Width
9/16" Thickness
4 Ft. Lengths



ADM363-POP



Poplar
1" Width
9/16" Thickness
1-1/4" design repeat



OWM-1471



Maple
1-1/4" Width
7/8" Thickness
8 Ft. Lengths



ADM366-POP



Poplar
1-5/16" Width
1/2" Thickness
1-9/16" design repeat
8 Ft. Lengths



ROPE MOULDINGS

OWM-1705



Maple Veneer
1/4" Width
3/16" Thickness
4 Ft. Lengths



ROPE-500-MP-R



Maple
1/2" Width
8 Ft. Lengths



ROPE-750-MP



Maple
3/4" Width x
8 Ft. Lengths



OWM-1706



Maple Veneer
3/8" Width
3/16" Thickness
4 Ft. Lengths



WOOD MOULDINGS

ROPE MOULDINGS

OWM-1714



Maple
1/2" Width
3/16" Thickness
4 Ft. Lengths



OWM-1710



Maple Veneer
11/16" Width
3/16" Thickness
4 Ft. Lengths



OWM-1707



Maple
11/16" Width
5/16" Thickness
4 Ft. Lengths



ADM356-POP



Poplar
13/16" Width
7/16" Thickness
9/16" design repeat
8 Ft. Lengths



ADM364-POP



Poplar
1" Width
1/4" Thickness
1/4" design repeat
8 Ft. Lengths



OWM-1727



Maple
1" Width
1/2" Thickness
8 Ft. Lengths



DECORATIVE FLAT MOULDINGS

ADM354-POP



Poplar
1-1/4" Width
11/32" Thickness
1-7/16" design repeat
8 Ft. Lengths



ADM365-POP



Poplar
1-1/4" Width
5/16" Thickness
9/16" design repeat
8 Ft. Lengths



ADM350-POP



Poplar
1-1/2" Width
11/32" Thickness
1-1/4" design repeat
8 Ft. Lengths



ADM351-POP



Poplar
1-3/4" Width
7/16" Thickness
3-1/16" design repeat
8 Ft. Lengths



OWM-1719



Maple
2" Width
1/4" Thickness
4 Ft. Lengths



OWM-1737



Maple
2-5/16" Width
1/4" Thickness
8 Ft. Lengths



WOOD MOULDINGS

DECORATIVE MOULDINGS

OWM-1708



Maple
3/4" Width
3/8" Thickness
4 Ft. Lengths

OWM-1478



Maple
7/8" Width
1/2" Thickness
8 Ft. Lengths

OWM-1711



Maple
1" Width
1/2" Thickness
4 Ft. Lengths

OWM-1455



Maple
2-1/8" Width
13/16" Thickness
8 Ft. Lengths

SQUARES

OWM-1722



Maple
5/8" Width
3/16" Thickness
4 Ft. Lengths

ADM-362-POP



Poplar
7/8" Width
5/16" Thickness
7/8" design repeat
8 Ft. Lengths

OWM-1766



Maple
7/8" Width
1/2" Thickness
4 Ft. Lengths

OWM-1732



Maple
1" Width
1/4" Thickness
8 Ft. Lengths

OWM-1733



Maple
1-9/16" Width
5/16" Thickness
4 Ft. Lengths

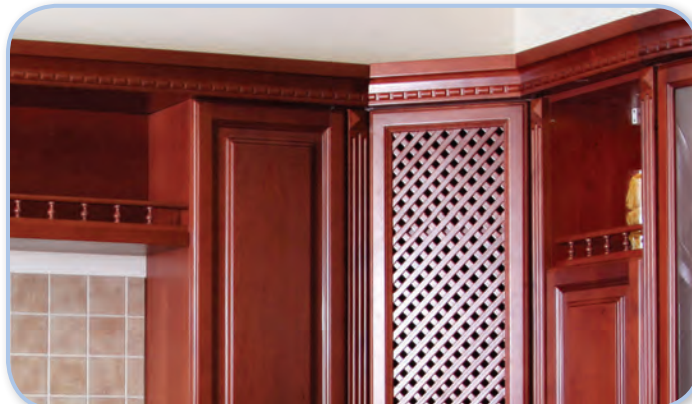

HARD MAPLE MOULDINGS & CORNER CURVES

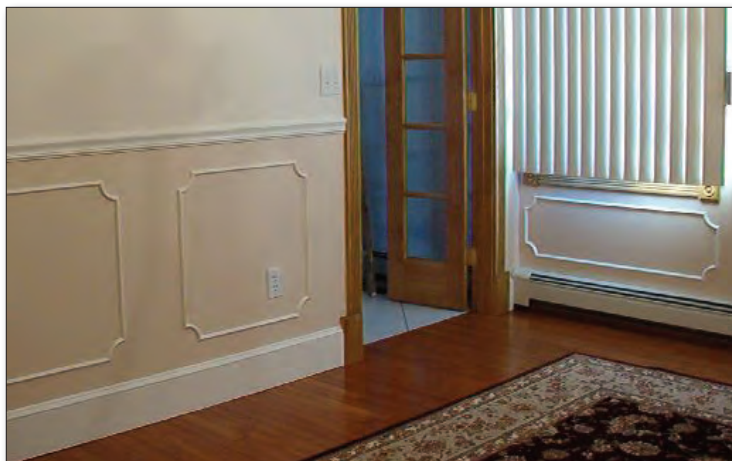

(WD-316MP-6 & WD3160MP Shown)

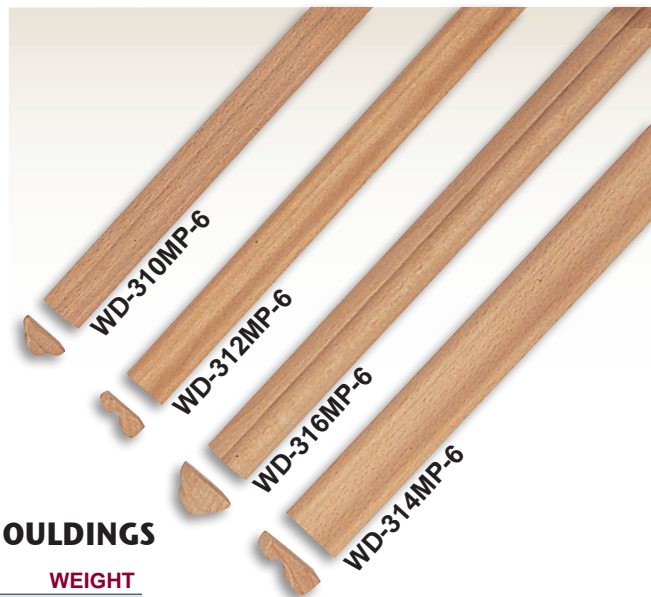

STRAIGHT CABINET MOULDINGS

PART #	SIZE	WEIGHT
WD-310MP-6	1/2"x1/4" 6ft. long	.21 lbs.
WD-312MP-6	1/2"x1/4" 6ft. long	.21 lbs.
WD-314MP-6	3/4"x1/4" 6ft. long	.3 lbs.
WD-316MP-6	5/8"x3/8" 6ft. long	.3 lbs.

CORNER CURVES

PART #	SIZE	WEIGHT
WD-3100MP	1/2"x1/4"x2 3/4" Radius 1 3/4"	.01 lbs.
WD-3101MP	1/2"x1/4"x1 1/2" Radius 7/8"	.01 lbs.
WD-3120MP	1/2"x1/4" x2 3/4" Inside Radius 1 3/4"	.01 lbs.
WD-3121MP	1/2"x1/4"x 1-1/2" Inside Radius 7/8"	.01 lbs.
WD-3140MP	3/4"x1/4"x3-3/8" Radius 2"	.15 lbs.
WD-3141MP	3/4"x1/4"x2-1/4" Radius 1 1/4"	.2 lbs.
WD-3160MP	5/8"x3/8"x 3-1/4" 2" Radius	.15 lbs.
WD-3161MP	5/8"x3/8"x2" 1-1/4" Radius	.2 lbs.

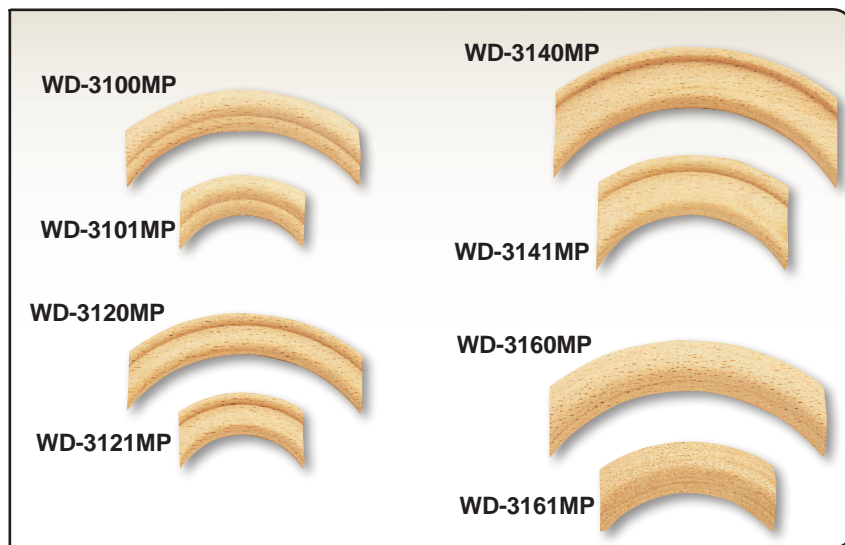

RED OAK & MAPLE E-Z MOULDING

USE S6 OR S12 SLOTTER - 8 FT. LENGTHS

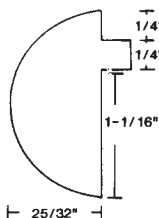

HALF-ROUND STYLE

PART #	DESCRIPTION
HR8	Red Oak
HR8-MP	Maple

- Great for: kids rooms, wall borders, galley rail.
- A perfect accent for any application.
- Can be painted or stained.

These mouldings are available in Maple Veneer.

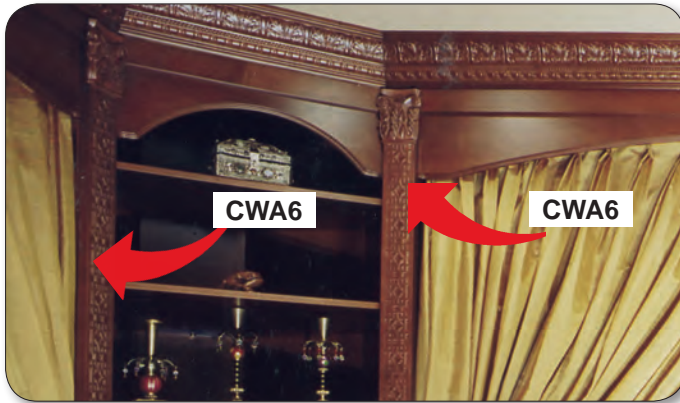

LASER CARVED MOULDINGS

47-1/2" Nominal Lengths
Approximate Thickness is 1/4"

- A. Grape
- B. Scallop
- C. Ovals
- D. Rectangle
- E. Train
- F. Horse



PART #	DESCRIPTION	HEIGHT	DESIGN REPEAT
A CWA1	Grape	3-1/4"	9-1/2"
B CWA2	Scallop	3-1/8"	5-1/4"
C CWA4	Ovals	3-1/4"	5-1/4"
D CWA6	Rectangle	3-3/8"	3-5/8"
E CWA9	Train	3-1/4"	11-7/8"
F CWA11	Horse	3-1/4"	13-13/16"

PRESSED WOOD MOULDINGS

4' Lengths
Approximate Thickness is 1/8"

- G. Cameo
- H. Leaf
- I. Clove
- J. Diamond



PART #	DESCRIPTION	HEIGHT	DESIGN REPEAT
G CWA13	Cameo	2-3/16"	3"
H CWA14	Leaf	2"	1-5/8"
I CWA15	Clove	2"	5-5/8"
J CWA16	Diamond	2-3/8"	2-1/2"

CARVED PIERCED MOULDINGS

2 ft. lengths, available in Hard Maple, Red Oak, and Cherry.

Our carved wood pierced mouldings have an innovative dowel system for creating a continuous run of multiple pieces.

Apply wood glue to both ends of the dowels (sold separately). Insert into pre-drilled holes on either end of the two pieces to be joined. Space pieces proportionate to the design repeat. All pieces are sanded and unfinished - ready for staining or painting.

The dowels blend into the pattern for a consistent, uninterrupted look. Holes on either side of the moulding can be plugged by gluing the dowels in place, then cut to fit and sand flush for a continuous look.



CPM-R20* Rose 3" high x 7/8" deep x 24" long x 12" design repeat - Maple *(M) Oak *(OAK) Cherry *(CH)



CPM-AC50* Acorn 3" high x 7/8" deep x 24" long x 12" design repeat - Maple *(M) Oak *(OAK) Cherry *(CH)



CPM-A30* Acanthus Leaf 3" high x 7/8" deep x 24" long x 12" design repeat - Maple *(M) Oak *(OAK) Cherry *(CH)



CPM-F40* Fruit 3" high x 7/8" deep x 24" long x 12" design repeat - Maple *(M) Oak *(OAK) Cherry *(CH)



CPM-G10* Grape 3" high x 7/8" deep x 24" long x 12" design repeat - Maple *(M) Oak *(OAK) Cherry *(CH)

* Add wood code to end of each part number when ordering, Ex: CPM-R20-OAK

Create a continuous run of multiple pieces with our innovative dowel system (sold separately).



STYLE	PART #	WOOD SPECIES
Plain Dowel Connector	CPD-DOWEL-M	Maple
Plain Dowel Connector	CPD-DOWEL-CH	Cherry
Plain Dowel Connector	CPD-DOWEL-OAK	Oak
<i>Works with CPM-R20, CPM-A30 & CPM-F40</i>		
Carved Dowel Connector	CPC-DOWEL-M	Maple
Carved Dowel Connector	CPC-DOWEL-CH	Cherry
Carved Dowel Connector	CPC-DOWEL-OAK	Oak
<i>Works with CPM-G10 & CPM-AC50</i>		

HAND CARVED SOLID NORTH AMERICAN HARDWOOD CHAIR RAIL & CROWN MOULDINGS

Our 3" & 5" crown and chair rails match the same motifs as our pierced mouldings with a 12" design repeat.

8 ft. lengths, available in
Hard Maple, Red Oak, and Cherry.

3" HAND CARVED HARDWOOD MOULDING

CHAIR RAIL

PART #	DESIGN	MAPLE *(M)	RED OAK *(OAK)	CHERRY *(CH)
A CHR3-R20*	Rose			
B CHR3-AC50*	Acorn			
C CHR3-A30*	Acanthus Leaf			
D CHR3-F40*	Fruit			
E CHR3-G10*	Grape			

CROWN MOULDING

A CRN3-R20*	Rose			
B CRN3-AC50*	Acorn			
C CRN3-A30*	Acanthus Leaf			
D CRN3-F40*	Fruit			
E CRN3-G10*	Grape			

3" CHAIR RAIL
PROFILE



3" CROWN
MOULDING
PROFILE

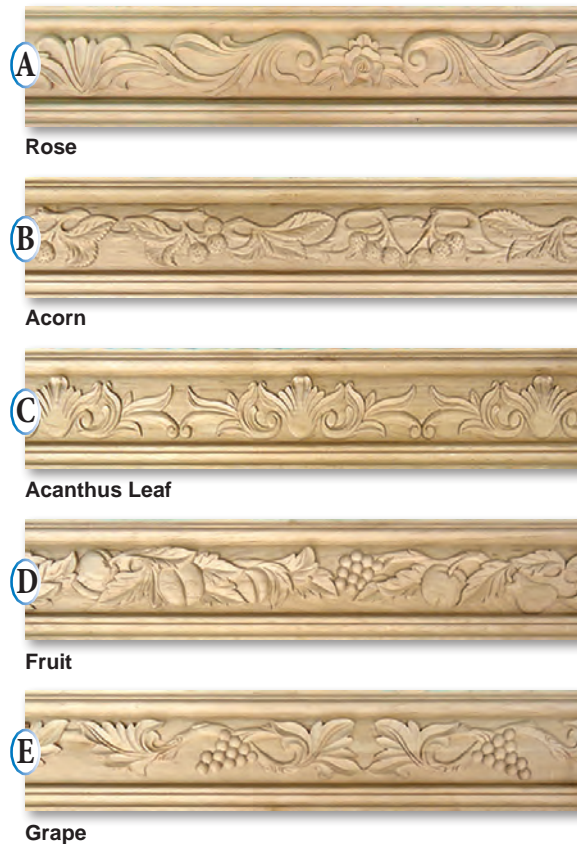
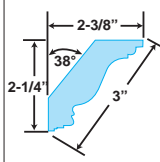

5" HAND CARVED HARDWOOD MOULDING

CHAIR RAIL

PART #	DESIGN	MAPLE *(M)	RED OAK *(OAK)	CHERRY *(CH)
A CHR5-R20*	Rose			
B CHR5-AC50*	Acorn			
C CHR5-A30*	Acanthus Leaf			
D CHR5-F40*	Fruit			
E CHR5-G10*	Grape			

CROWN MOULDING

A CRN5-R20*	Rose			
B CRN5-AC50*	Acorn			
C CRN5-A30*	Acanthus Leaf			
D CRN5-F40*	Fruit			
E CRN5-G10*	Grape			

5" CHAIR RAIL
PROFILE



5" CROWN
MOULDING
PROFILE

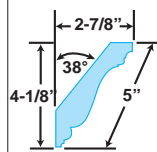

* Add wood code to end of each part number when ordering, Example: CRN5-R20-CH

8 ft. lengths, available in Red Oak, Maple, White Oak & Cherry.

3" HARDWOOD MOULDING

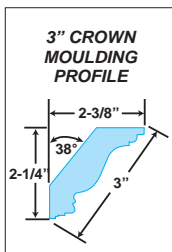
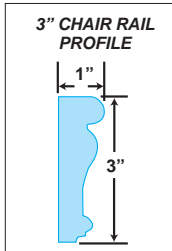

CHAIR RAIL				
PART #	MAPLE *(MP)	RED OAK *(RO)	CHERRY *(CH)	WHITE OAK *(WHO)
A HW-SCR3-CHR-*				
B HW-FLO3-CHR-*				
C HW-GRP3-CHR-*				
D HW-OKL3-CHR-*				
E HW-SHL3-CHR-*				
CROWN MOULDING				
A HW-SCR3-CRN-*				
B HW-FLO3-CRN-*				
C HW-GRP3-CRN-*				
D HW-OKL3-CRN-*				
E HW-SHL3-CRN-*				



5" HARDWOOD MOULDING

CHAIR RAIL				
PART #	MAPLE *(MP)	RED OAK *(RO)	CHERRY *(CH)	WHITE OAK *(WHO)
A HW-SCR5-CHR-*				
B HW-FLO5-CHR-*				
C HW-GRP5-CHR-*				
D HW-OKL5-CHR-*				
E HW-SHL5-CHR-*				
CROWN MOULDING				
A HW-SCR5-CRN-*				
B HW-FLO5-CRN-*				
C HW-GRP5-CRN-*				
D HW-OKL5-CRN-*				
E HW-SHL5-CRN-*				

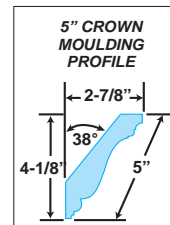
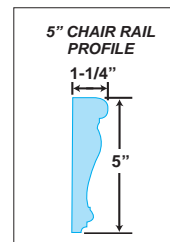

* Add wood code to end of each part number when ordering, Example: HW-SCR5-CRN-CH

CHAIR RAIL & CROWN MOULDINGS

SOLID WOOD HAND CARVED MOULDINGS

These mouldings are made of Medium Density Light Grain White Wood (Similar to Bass Wood), 8 ft. lengths.

Can be painted or faux finished with a quality latex or oil based product. Can be stained with standard stains.

*****Maple and Cherry are available upon request. A minimum 8 weeks lead time applies.*****



12" Repeat

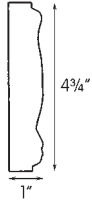

12" Repeat

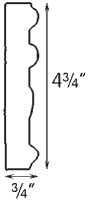

6" Repeat

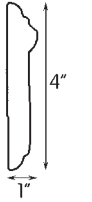

1-1/4" Repeat

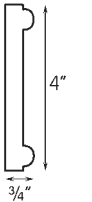

12" Repeat

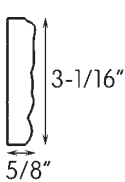

12" Repeat

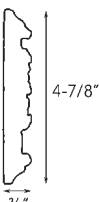

12" Repeat



CHAIR RAIL

PART

A	CARM-6-CR
B	CARM-4-CR
C	CARM-3-CR
D	CARM-2-CR
E	CARM-1-CR
F	CARM-7-CR
G	CARM-5-CR

CROWNS

H	CARM-2-C
I	CARM-3-C
J	CARM-1-C

HALF ROUND

K	CARM-1-HR
---	-----------

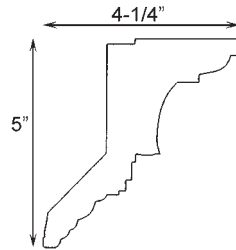

6" Repeat

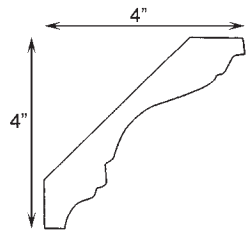

3" Repeat

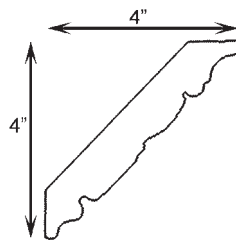

12" Repeat



3-1/4" Repeat

ROPE RIBBON MOULDINGS

A unique line of wood mouldings. Mouldings can be stained or painted.

Available in, Maple, Cherry & Red Oak, 8 ft. lengths.



CROWN MOULDING

RAM-275-*-R

2-3/4" H x 13/16" Thick
1/2" Rope, 1-11/16" Proj.

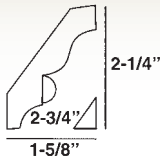

COLOR

- RED OAK (RO)
- MAPLE (MP)
- CHERRY (CH)

RAM-338-*-R

3-3/8" H x 3/4" Thick
1/2" Rope, 2-3/16" Proj.

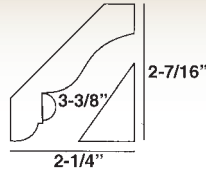

COLOR

- RED OAK (RO)
- MAPLE (MP)
- CHERRY (CH)

RAM-425-*-R

4-1/4" H x 13/16" Thick
1/2" Rope, 2-7/16" Proj.

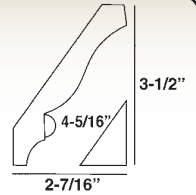

COLOR

- RED OAK (RO)
- MAPLE (MP)
- CHERRY (CH)

RAM-575-*-R

5-3/4" H x 7/8" Thick
3/4" Rope, 4-3/16" Proj.

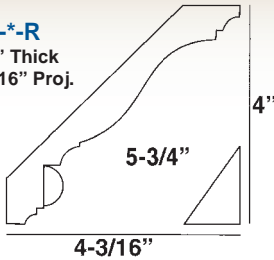

COLOR

- RED OAK (RO)
- MAPLE (MP)
- CHERRY (CH)

CHAIR RAIL MOULDING

RAM-225-*-R

2-1/4" H x 11/16" Thick
3/4" Rope



COLOR

- RED OAK (RO)
- MAPLE (MP)
- CHERRY (CH)

SHELF EDGE MOULDING

RAM-138-*-R

1-3/8" H x 5/8" Thick
1/2" Rope



COLOR

- RED OAK (RO)
- MAPLE (MP)
- CHERRY (CH)

BASE MOULDING

RAM-350-*-R

3-1/2" H x 9/16" Thick
1/2" Rope

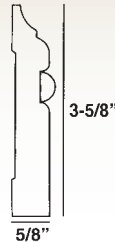

COLOR

- RED OAK (RO)
- MAPLE (MP)
- CHERRY (CH)

RAM-525-*-R

5-1/4" H x 9/16" Thick
3/4" Rope

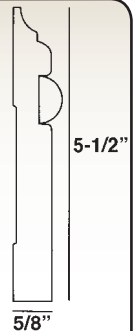

COLOR

- RED OAK (RO)
- MAPLE (MP)
- CHERRY (CH)



For rope ribbon accent mouldings, see page 473.

ROPE ACCENTED MOULDINGS

A unique line of wood mouldings. Mouldings can be stained or painted.

Available in, Maple, Cherry & Red Oak, 8 ft. lengths.

CROWN MOULDING

RAM-200-
2"H x 1-1/8" Thick
1/2" Rope

COLOR
RED OAK (RO)
MAPLE (MP)
CHERRY (CH)

RAM-275-
2-3/4"H x 13/16" Thick
1/2" Rope, 1-11/16" Proj.

COLOR
RED OAK (RO)
MAPLE (MP)
CHERRY (CH)

RAM-338-
3-3/8"H x 3/4" Thick
1/2" Rope, 2-3/16" Proj.

COLOR
RED OAK (RO)
MAPLE (MP)
CHERRY (CH)

RAM-425-
4-1/4"H x 13/16" Thick
1/2" Rope, 2-7/16" Proj.

COLOR
RED OAK (RO)
MAPLE (MP)
CHERRY (CH)

CHAIR RAIL MOULDING

RAM-225-
2-1/4"H x 11/16" Thick
3/4" Rope

COLOR
RED OAK (RO)
MAPLE (MP)
CHERRY (CH)

SHELF EDGE MOULDING

RAM-138-
1-3/8"H x 5/8" Thick
1/2" Rope

COLOR
RED OAK (RO)
MAPLE (MP)
CHERRY (CH)

RAM-575-
5-3/4"H x 7/8" Thick
3/4" Rope, 4-3/16" Proj.

COLOR
RED OAK (RO)
MAPLE (MP)
CHERRY (CH)

BASE MOULDING

RAM-350-
3-1/2"H x 9/16" Thick
1/2" Rope

COLOR
RED OAK (RO)
MAPLE (MP)
CHERRY (CH)

RAM-525-
5-1/4"H x 9/16" Thick
3/4" Rope

COLOR
RED OAK (RO)
MAPLE (MP)
CHERRY (CH)

THE WOOD PLUS COLLECTION

Mouldings are available in 8 ft. lengths.

The design & detail of these mouldings is made from a mixture of polymers, contoured onto a soft wood substrate similar to pine. This results in a product with incredible detail while adding minimally to the cost.

- *Installs with standard woodworking tools.*
- *Can be painted/stained, using a non-penetrating gel stain.*

CROWNS

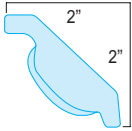
CWM-2-C Egg & Dart
(3" x 7/8")
Design Repeat - 3"

CORNERS ARE NOT AVAILABLE IN THIS ITEM

WPC-100



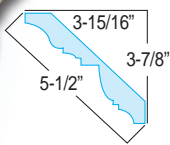

Design Repeat: 1-3/4"
Thickness: 7/8"



INSIDE CORNER
WPC-100-IC

12" x 12" CORNERS



OUTSIDE CORNER
WPC-100-OC

WPC-103

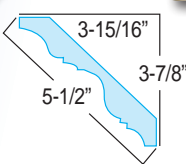



Design Repeat: 2-3/8"
Thickness: 7/8"



INSIDE CORNER
WPC-103-IC

12" x 12" CORNERS



OUTSIDE CORNER
WPC-103-OC

WPC-106

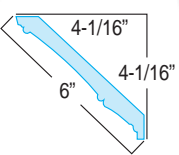



Design Repeat: 7-1/2"
Thickness: 3/4"



INSIDE CORNER
WPC-106-IC

12" x 12" CORNERS



OUTSIDE CORNER
WPC-106-OC

THE WOOD PLUS COLLECTION

Mouldings are available in 8 ft. lengths.

The design & detail of these mouldings is made from a mixture of polymers, contoured onto a soft wood substrate similar to pine. This results in a product with incredible detail while adding minimally to the cost.

- *Installs with standard woodworking tools.*
- *Can be painted/stained, using a non-penetrating gel stain.*

CROWNS

WPC-109



Design Repeat: 4-5/16"
Thickness: 7/8"

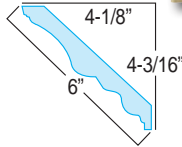

INSIDE
CORNER
WPC-109-IC

12" x 12" CORNERS



OUTSIDE
CORNER
WPC-109-OC

WPC-112



Design Repeat: 4-5/16"
Thickness: 7/8"

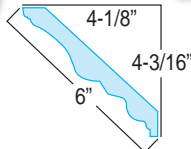

INSIDE
CORNER
WPC-112-IC

12" x 12" CORNERS



OUTSIDE
CORNER
WPC-112-OC

WPC-115



Design Repeat: 4-5/16"
Thickness: 7/8"

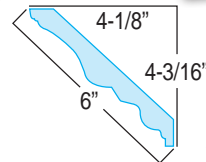

INSIDE
CORNER
WPC-115-IC

12" x 12" CORNERS



OUTSIDE
CORNER
WPC-115-OC

WPC-118



Design Repeat: 12-3/16"
Thickness: 7/8"

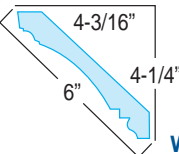

INSIDE
CORNER
WPC-118-IC

12" x 12" CORNERS



OUTSIDE
CORNER
WPC-118-OC

THE WOOD PLUS COLLECTION

Mouldings are available in 8 ft. lengths.

The design & detail of these mouldings is made from a mixture of polymers, contoured onto a soft wood substrate similar to pine. This results in a product with incredible detail while adding minimally to the cost.

- *Installs with standard woodworking tools.*
- *Can be painted/stained, using a non-penetrating gel stain.*

CROWNS

WPC-121



Design Repeat: 7-1/16"
Thickness: 7/8"

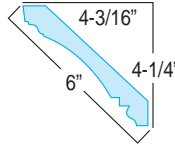

INSIDE CORNER
WPC-121-IC

12" x 12" CORNERS

OUTSIDE CORNER
WPC-121-OC



WPC-124



Design Repeat: 4-5/16"
Thickness: 7/8"

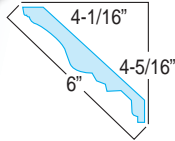

INSIDE CORNER
WPC-124-IC

12" x 12" CORNERS

OUTSIDE CORNER
WPC-124-OC



WPC-127



Design Repeat: 5-7/8"
Thickness: 1-1/8"

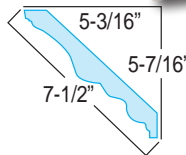

INSIDE CORNER
WPC-127-IC

12" x 12" CORNERS

OUTSIDE CORNER
WPC-127-OC



WPC-130



Design Repeat: 7-1/16"
Thickness: 1-9/16"

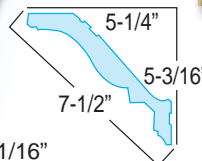

INSIDE CORNER
WPC-130-IC

12" x 12" CORNERS

OUTSIDE CORNER
WPC-130-OC



THE WOOD PLUS COLLECTION

Mouldings are available in 8 ft. lengths.

The design & detail of these mouldings is made from a mixture of polymers, contoured onto a soft wood substrate similar to pine. This results in a product with incredible detail while adding minimally to the cost.

- **Installs with standard woodworking tools.**
- **Can be painted/stained, using a non-penetrating gel stain.**

PANELS

WPC-300



Design Repeat: 1-9/16" Thickness: 5/8"

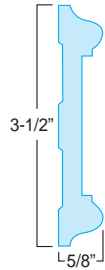

WPC-303



Design Repeat: 3/4" Thickness: 5/8"

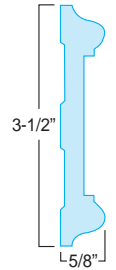

PANEL MOULDINGS



CWM-1-PM

Greek Key
(2 1/2" x 5/8")
Design Repeat - 1-1/8"

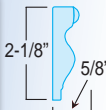
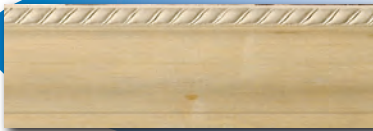

CWM-2-PM

Rope
(2-1/8" x 5/8")
Design Repeat - 3/8"

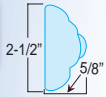

CWM-3-PM

Rope
(1" x 1/2")
Design Repeat - 3/8"

FRIEZES

WPC-200



Design Repeat: 8-1/4" Thickness: 3/4"

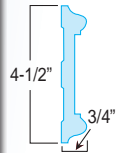

WPC-203



Design Repeat: 9-7/16" Thickness: 1"

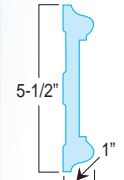

BACKBANDS

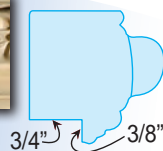
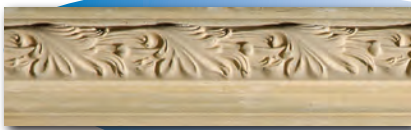

CWM-2-BB

Leaf
(2" x 1-7/8")
Design Repeat - 2"

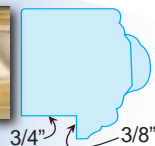
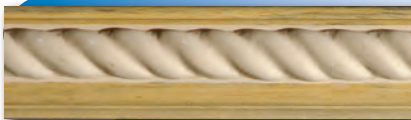

CWM-1-BB

Rope
(2" x 1 3/4")
Design Repeat - 7/8"

CASING

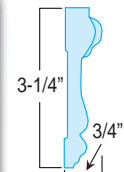

CWM-1-CS

Rope
(3 1/4" x 3/4")
Design Repeat - 7/8"

WOOD MOULDINGS

CLEAR POPLAR • 8 FT. LENGTHS

ASPEN DESIGNER SERIES

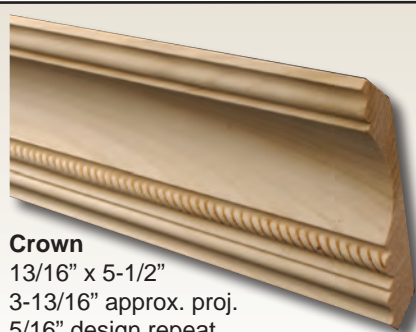

Crown
13/16" x 5-1/2"
3-13/16" approx. proj.
5/16" design repeat
ADM474-POP



Chair Rail
11/16" x 3", 1/4" design repeat
ADM674-POP



MILAN DESIGNER SERIES



Crown
13/16" x 4-1/2"
3-1/16" approx. proj. 7-7/8" design repeat
ADM478-POP



Chair Rail
11/16" x 4", 7-7/8" design repeat
ADM678-POP

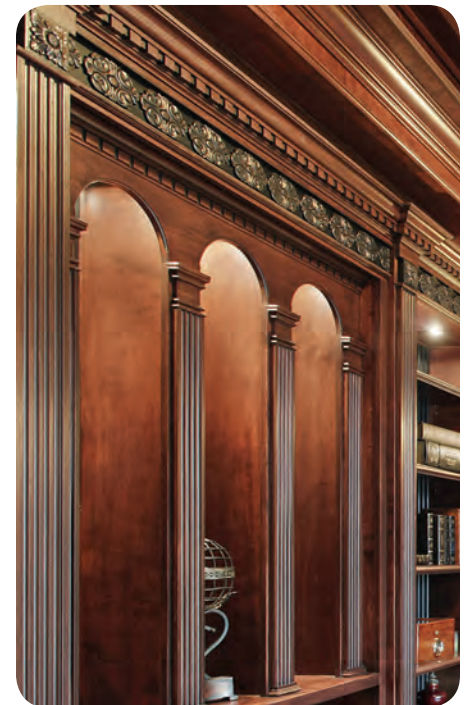

Baseboard
11/16" x 6", 7-13/16"
design repeat
ADM278-POP

SAVANNAH DESIGNER SERIES



Crown
3/4" x 4-1/8"
3" approx. proj. 9/16" design repeat
ADM453-POP



Casing
13/16" x 3-1/4",
9/16" design repeat
ADM151-POP

WOOD MOULDINGS

CLEAR POPLAR • 8 FT. LENGTHS

CHARLESTON DESIGNER SERIES



Crown
13/16" x 5-1/2",
1-5/8" design repeat
3-3/8" approx. projection
ADM461-POP



Crown
13/16" x 4-7/16"
2-9/16" approx. proj. 1-5/8" design repeat
ADM458-POP



Chair Rail
11/16" x 2-1/2",
1-5/8" design repeat
ADM653-POP



Crown
3/4" x 3-11/16"
2-1/2" approx. proj. 1-1/4" design repeat
ADM460-POP

MONTEREY DESIGNER SERIES



Crown
13/16" x 5-1/2", 4" design repeat
3-3/8" approx. projection
ADM470-POP



Chair Rail
9/16" x 1-11/16", 3-7/8" design repeat
ADM670A-POP



Chair Rail
13/16" x 2-9/16", 5-5/8" design repeat
ADM670B-POP



Chair Rail
1-1/16" x 3-1/2", 7-3/16" design repeat
ADM670C-POP



Casing
13/16" x 3-1/4", 4" design repeat
ADM170-POP



Baseboard
11/16" x 5", 3-7/8" design repeat
ADM270-POP

WOOD MOULDINGS

CLEAR POPLAR • 8 FT. LENGTHS

FLORENCE DESIGNER SERIES



Crown
1-3/4" x 7-1/8"
3-15/16" approx. proj.
design repeat: none
ADM462-POP



Crown
13/16" x 5-1/2"
4" approx. proj.
2-7/8" design repeat
ADM473-POP

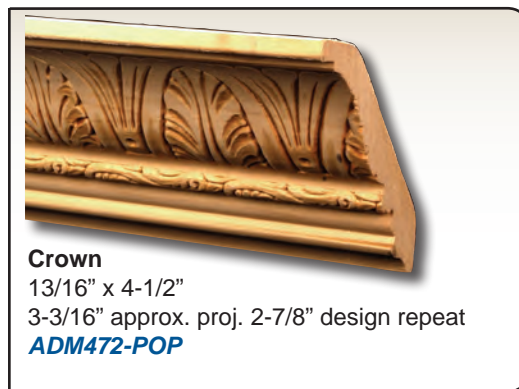

Crown
13/16" x 4-1/2"
3-3/16" approx. proj. 2-7/8" design repeat
ADM472-POP



Chair Rail
11/16" x 3-3/4", 2-7/8" design repeat
ADM672-POP



Baseboard
11/16" x 6",
2-7/16" design repeat
ADM272-POP

CANTERBURY DESIGNER SERIES



Chair Rail
11/16" x 1-1/2"
13/16" design repeat
ADM659-POP

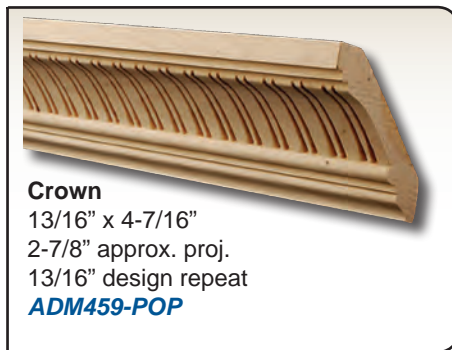

Crown
13/16" x 4-7/16"
2-7/8" approx. proj.
13/16" design repeat
ADM459-POP

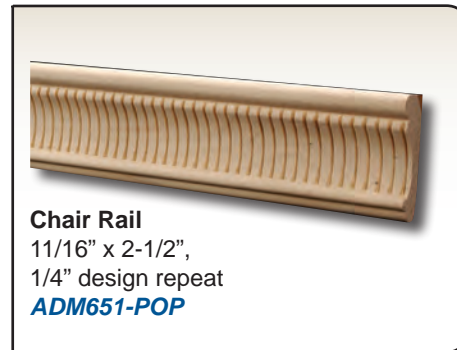

Chair Rail
11/16" x 2-1/2",
1/4" design repeat
ADM651-POP

WOOD MOULDINGS

CLEAR POPLAR • 8 FT. LENGTHS

MANHATTAN DESIGNER SERIES



Crown
1-1/4" x 6-1/4",
1-3/4" design repeat
4" approx. projection
ADM452-POP



Crown
13/16" x 5-1/2"
3-1/8" approx. proj.
1-3/4" design repeat
ADM456-POP

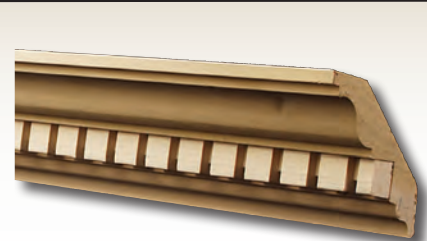

Crown
3/4" x 3-3/4"
2-1/2" approx. proj.
7/8" design repeat
ADM455-POP

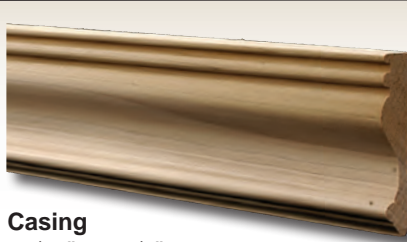

Casing
13/16" x 3-1/4",
no design repeat
ADM154-POP



Chair Rail
11/16" x 2-1/8", 1-1/8" design repeat
ADM650-POP



Baseboard
11/16" x 5", no design repeat
ADM256-POP

SOUTH HAMPTON DESIGNER SERIES



Crown
7/8" x 5-3/16"
3-1/6" approx. proj.
1-5/8" design repeat
ADM457-POP



Chair Rail
11/16" x 3",
1-1/16" design repeat
ADM655-POP

SIGNATURE SERIES WOOD RANGE HOODS



- Available in 30", 36" and 42" widths.
- Both styles are available in unfinished Oak, Maple and Cherry.
- Metal liner included.
- Installation instructions included.
- Chimney blowers and Duct kits sold separately.
- Chimney can be trimmed to fit different heights.
- Alder & Hickory Available - Please inquire.



ARCHED STYLE

PART #	SPECIES	HEIGHT	TOTAL WIDTH	HOOD WIDTH	DEPTH
SARAN30-OAK	Oak	24-7/8"	32-3/8"	30"	19"
SARAN30-MP	Maple	24-7/8"	32-3/8"	30"	19"
SARAN30-CH	Cherry	24-7/8"	32-3/8"	30"	19"
SARAN36-OAK	Oak	24-7/8"	38-3/8"	36"	19"
SARAN36-MP	Maple	24-7/8"	38-3/8"	36"	19"
SARAN36-CH	Cherry	24-7/8"	38-3/8"	36"	19"
SARAN42-OAK	Oak	24-7/8"	44-3/8"	42"	19"
SARAN42-MP	Maple	24-7/8"	44-3/8"	42"	19"
SARAN42-CH	Cherry	24-7/8"	44-3/8"	42"	19"

MANUAL VENTILATOR

- 500 CFM/8.2 sones
- Stainless Steel finish
- 2 x 20 watt halogen lamps
- Push button controls
- Quiet centrifugal blower
- Heat sensor detects excessive heat & adjusts automatically



VENT07

Designed for use with VENT07 & VENT08

DUCTWORK KIT

DUCTKIT

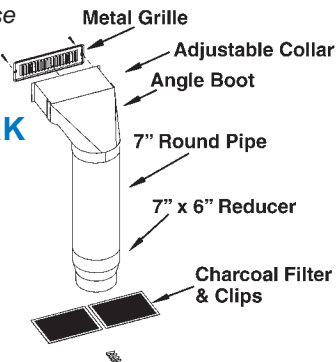

STRAIGHT STYLE

PART #	SPECIES	HEIGHT	TOTAL WIDTH	HOOD WIDTH	DEPTH
SSRAN30-OAK	Oak	22-7/8"	32-3/8"	30"	20-3/16"
SSRAN30-MP	Maple	22-7/8"	32-3/8"	30"	20-3/16"
SSRAN30-CH	Cherry	22-7/8"	32-3/8"	30"	20-3/16"
SSRAN36-OAK	Oak	22-7/8"	38-3/8"	36"	20-3/16"
SSRAN36-MP	Maple	22-7/8"	38-3/8"	36"	20-3/16"
SSRAN36-CH	Cherry	22-7/8"	38-3/8"	36"	20-3/16"
SSRAN42-OAK	Oak	22-7/8"	44-3/8"	42"	20-3/16"
SSRAN42-MP	Maple	22-7/8"	44-3/8"	42"	20-3/16"
SSRAN42-CH	Cherry	22-7/8"	44-3/8"	42"	20-3/16"

CHIMNEY

PART #	SPECIES	WORKS WITH	HEIGHT	WIDTH	DEPTH
CHI-30-OAK	Oak	SARAN30*, SSRAN30*	23-1/2"	11-7/16"	9-11/16"
CHI-30-MP	Maple	SARAN30*, SSRAN30*	23-1/2"	11-7/16"	9-11/16"
CHI-30-CH	Cherry	SARAN30*, SSRAN30*	23-1/2"	11-7/16"	9-11/16"
CHI-36-OAK	Oak	SARAN36*, SSRAN36*	23-1/2"	17-7/16"	9-11/16"
CHI-36-MP	Maple	SARAN36*, SSRAN36*	23-1/2"	17-7/16"	9-11/16"
CHI-36-CH	Cherry	SARAN36*, SSRAN36*	23-1/2"	17-7/16"	9-11/16"
CHI-42-OAK	Oak	SARAN42*, SSRAN42*	23-1/2"	23-7/16"	9-11/16"
CHI-42-MP	Maple	SARAN42*, SSRAN42*	23-1/2"	23-7/16"	9-11/16"
CHI-42-CH	Cherry	SARAN42*, SSRAN42*	23-1/2"	23-7/16"	9-11/16"

ARTISAN STYLE RANGE HOODS



- Available in 36" & 42" widths.
- Chimney allows for 12" of trim.
- Silver metallic liner included.
- Alder available, please inquire.

PART #	SPECIES	HEIGHT	WIDTH	DEPTH
ARAN36-OAK	Oak	46"	36"	19"
ARAN36-MP	Maple	46"	36"	19"
ARAN36-CH	Cherry	46"	36"	19"
ARAN42-OAK	Oak	46"	42"	19"
ARAN42-MP	Maple	46"	42"	19"
ARAN42-CH	Cherry	46"	42"	19"

WOOD CANOPY RANGE HOODS

- Available in 30" or 36" widths.
- Classic style available in unfinished Alder, unfinished Red Oak, unfinished Maple or unfinished Cherry.
- Sanded and ready to finish.
- Produced using top quality hardwoods and "A" grade veneers.
- Simple installation instructions included.
- Metallic Silver Liner included.
- Ventilators sold separately.
- Attractive professional appearance.
- Very quiet operation.
- Simple filter removal/cleaning.
- 3 year warranty.
- Omega series supplied with Galley Rail package.



CLASSIC SERIES

PART #	SPECIES	WIDTH	HEIGHT	DEPTH
CLARAN30-RO	Red Oak	30"	23-1/2"	8-5/16"
CLARAN30-MP	Maple	30"	23-1/2"	8-5/16"
CLARAN30-CH	Cherry	30"	23-1/2"	8-5/16"
CLARAN30-AL	Alder	30"	23-1/2"	8-5/16"
CLARAN36-RO	Red Oak	36"	23-1/2"	8-5/16"
CLARAN36-MP	Maple	36"	23-1/2"	8-5/16"
CLARAN36-CH	Cherry	36"	23-1/2"	8-5/16"
CLARAN36-AL	Alder	36"	23-1/2"	8-5/16"



OMEGA SERIES

PART #	SPECIES	HEIGHT	WIDTH	DEPTH
OMERAN30-RO	Red Oak	24"	30"	7-1/4"
OMERAN30-MP	Maple	24"	30"	7-1/4"
OMERAN30-CH	Cherry	24"	30"	7-1/4"
OMERAN30-AL	Alder	24"	30"	7-1/4"
OMERAN36-RO	Red Oak	24"	36"	7-1/4"
OMERAN36-MP	Maple	24"	36"	7-1/4"
OMERAN36-CH	Cherry	24"	36"	7-1/4"
OMERAN36-AL	Alder	24"	36"	7-1/4"

MANUAL VENTILATOR

- 250 CFM
- Silver Metallic finish
- 2 x 40 watt lamps
- Quiet centrifugal blower with 3-Speed slide control
- Heat sensor detects excessive heat & adjusts automatically



VENT08

Designed for use with
VENT07 & VENT08

DUCTWORK KIT

DUCTKIT

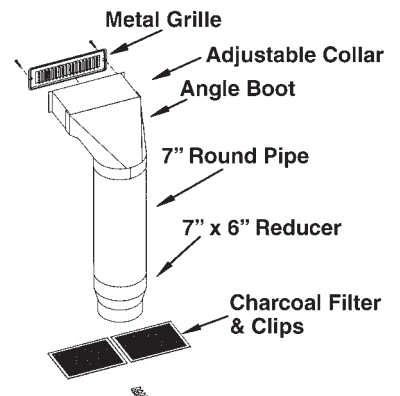

APPLIANCE GARAGE DOOR KITS

TAMBOUR "GARAGE" DOORS 400 SERIES

- Unfinished & ready to be stained.
- May be used horizontally or vertically.
- Extremely economical with two 1-1/2" leaders on the long side yields four to six doors.
- Works with our Track Systems A, 855-856, FTT, P-Spiral, PT, LT, UT, T-48, & ST2.
- Heavy duty 7 oz. Duck Canvas backing insures strength, stability & long life.

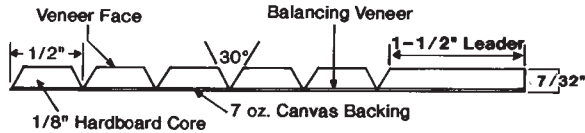

See page 558
for Tambour Sheets

AVAILABLE IN 6 WOOD VENEER FACINGS:

- Plain Sliced Red Oak
- Plain Sliced Maple
- Plain Sliced Cherry
- "Uniform White Birch"
- Hickory
- Alder
- Nominal 3' x 4'

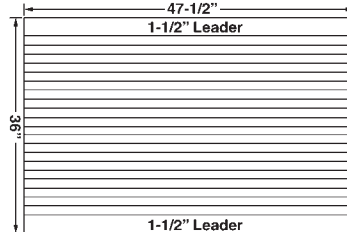

PART # WOOD FACE

412-RO	Red Oak
413-MP	Maple
415-CH	Cherry
416-WB	White Birch
417-HIC	Hickory

6' SLAT LENGTHS FOR LARGER APPLICATIONS

Same high quality construction series

AVAILABLE IN 3 WOOD VENEER FACINGS:

- Plain Sliced Red Oak
- Plain Sliced Maple
- "Uniform" White Birch
- Nominal 40" x 72"

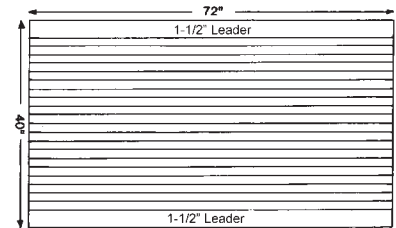

PART # WOOD FACE

412-RO-6	Red Oak
413-MP-6	Maple
416-WB-6	White Birch

FROSTY WHITE TAMBOUR DOOR

1400 SERIES

- Durable white-painted Euro-style tambour door for kitchen appliance garages, roll tops and more.
- Closely matches to Wilsonart's #1573-60 Frosty White, with semi-gloss finish.
- White fabric backing.
- Works with our Track Systems A, 855-856, FTT, LT, UT, T-48, & ST2.

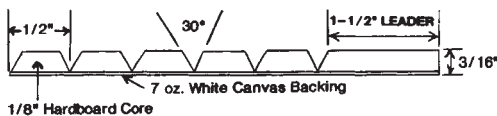
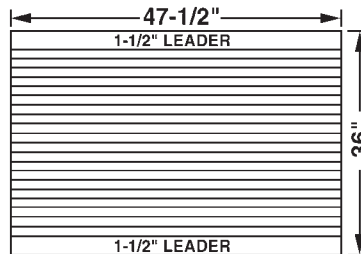
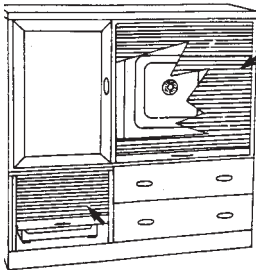

PART #
1400-WH



NOTE: Custom colors available with 15 piece orders.

UNFINISHED SOLID WOOD TAMBOUR

TAMBOUR "GARAGE" DOORS

- Sanded & ready to be stained.
- 7 oz. Brown Cloth Backer.
- Works with our Track Systems A, 855-856, FTT, PT, LT, UT, T-48, ST2.

PART	WOOD FACE
1275-RO	Red Oak
1275-MP	Maple
1275-HIC	Hickory
1275-CH	Cherry
1275-AL	Alder
1275-WAL	Walnut

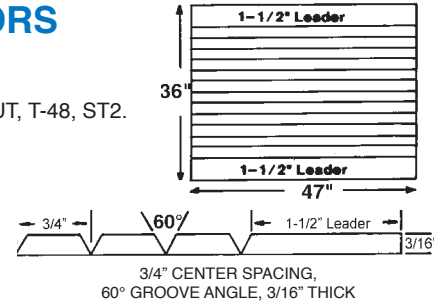

See page 558 for Tambour Sheets

UNFINISHED SOLID WOOD TAMBOUR DOORS

1375A

5/16" THICK, 3/4" CENTER SPACING, 30° GROOVE ANGLE

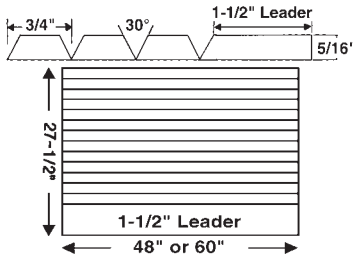

PART #
1375A-4
1375A-5

• Maple & Cherry Available. Please Inquire.



Our Solid Oak Doors with 7 oz. Heavy Duty Canvas Backing makes for an ideal door in custom & flagship projects.

- Heavy duty 7 oz. Duck Canvas Backing.
- Sanded & ready for staining.
- Works with our Track System B.
- Size is nominal.

1383

5/16" THICK, 3/4" HALF ROUND

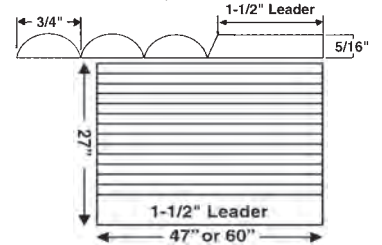

PART #	FINISH
1383-4	Oak
1383-4-MP	Maple
1383-4-CH	Cherry
1383-5	Oak
1383-5-MP	Maple
1383-5-CH	Cherry

VENEER TAMBOUR DOORS FOR LARGER APPLICATIONS

We are pleased to present the **'ROLL TOP DESK DOOR'**
This is a sectioned wood veneer door perfect for roll top desks or other expanded dimension uses.

- 3/4" slat width with 30° V-groove.
- Nominal 40" wide x 72" slat length.
- Two 1-1/2" leaders.
- Works with our Track Systems A, 855-856, FTT, LT, UT, T-48 & ST2.

PART #	WOOD FACE
1577-RO	Red Oak
1577-CH	Cherry
1577-MP	Maple

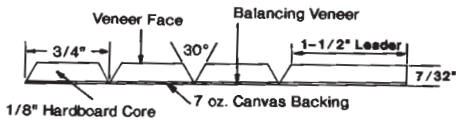
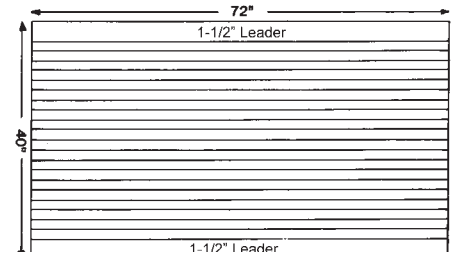

FUNCTIONAL TAMBOUR DOORS

UNFINISHED HARDBOARD DOOR - NOMINAL 4' x 8' SHEETS
1/8" Unfinished Hardboard with Heavy Duty 7 oz. Duck Canvas Backing

Works with our Track Systems P-Spiral, PT, LT, UT, T-48, & ST2.

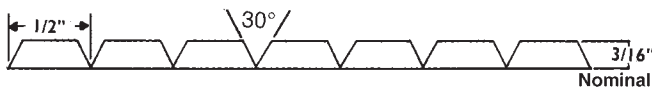

PART #
1267



RECESSED MOUNT TRACK SYSTEM

Material: PVC, White or Brown

- Easy to cut desired lengths.
- Track can be routed 3/8" deep x 9/16" wide groove or stapled directly to end panels.
- All styles accept a maximum thickness of 7/32".

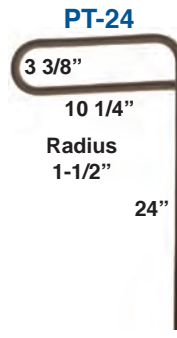
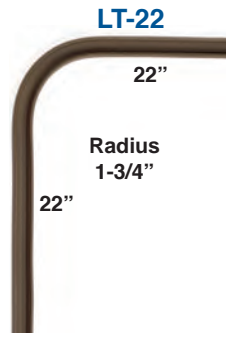
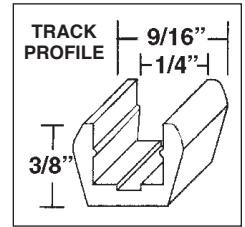

PART #	COLOR	DESCRIPTION
PT-24-BR	Brown	P Track
PT-24-WH	White	P Track
LT-22-BR	Brown	L Track
LT-22-WH	White	L Track
UT-24-BR	Brown	U Track
UT-24-WH	White	U Track
T-48-BR	Brown	Straight Track
T-48-WH	White	Straight Track

See page 558 for Tambour Sheets

PLASTIC TAMBOUR TRACK

INTERCHANGEABLE TRACK AND CURVES

(Check Your Door Thickness For Proper Track System)

APPLICATION
HORIZONTAL OR VERTICAL

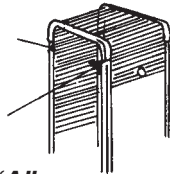
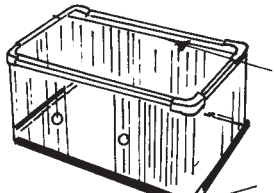

SYSTEM "A"

For Door Thickness 1/8"-3/16"
Stocked in Brown or Black

CURVE
SYSTEM A...4C51 SYSTEM B...4C55

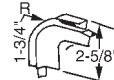

PLASTIC TRACK

*-AVAILABLE IN 4 FT. OR 8 FT. LENGTHS
SYSTEM A...4T5C SYSTEM B...4T54

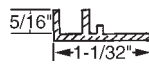

INSTALLATION

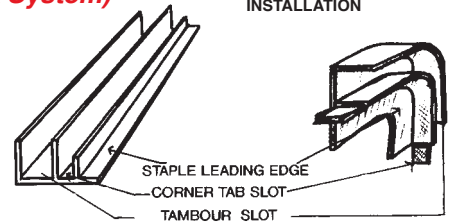

SYSTEM "B"

For Door Thickness 1/4"-5/16"
Brown Only

PART #	SYSTEM "A" DESCRIPTION
4C51-BR	Brown tambour track curve for 1/8"-3/16" thick doors
4C51-BK	Black tambour track curve for 1/8"-3/16" thick doors
4T5C-BR-*	Brown tambour door track for 1/8"-3/16" thick doors
4T5C-BK-*	Black tambour door track for 1/8"-3/16" thick doors

PART #	SYSTEM "B" DESCRIPTION
4C55-BR	Brown tambour track curve for 1/4"-5/16" thick doors
4T54-BR-*	Brown tambour door track for 1/4"-5/16" thick doors

P-SPIRAL PLASTIC TAMBOUR TRACK

FOR 3/16" DOOR THICKNESS

(Check Your Door Thickness For Proper Track System)
FOR VERTICAL USE ONLY

3-3/4" Wide

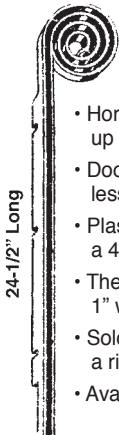

- Horizontal System will accept up to 21" of tambour length.
- Doors should be cut 1/16"-1/8" less than distance between tracks.
- Plastic spirals require approximately a 4-5/8" square area for mounting.
- The track requires approximately 1" width for mounting.
- Sold in pairs only, consisting of a right & left side.
- Available in Brown.

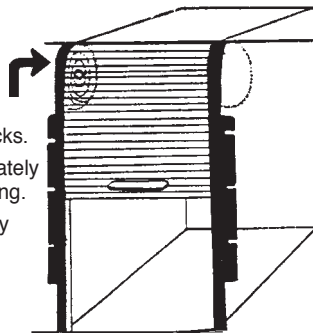

PART #	COLOR
P-187-BR	Brown

P-187 WORKS BEST WITH OUR 400 & 700 TAMBOUR SERIES

ROLL TOP DESK TRACK

FOR 1/4" DOOR THICKNESS

(Check Your Door Thickness For Proper Track System)

Dark Brown Only

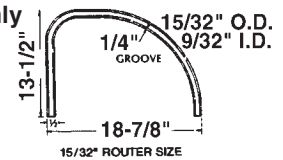

PART #
855-856

FLEXIBLE TAMBOUR TRACK

FOR 1/4" DOOR THICKNESS • 8 FT. LONG

(Check Your Door Thickness For Proper Track System)

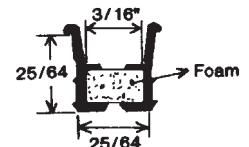

PART #	COLOR
FTT-BK	Black
FTT-WH	White

APPLIANCE GARAGE DOOR KITS



CORNER UNIT

Appliance garage with solid wood tambour door mounted to solid wood face frame. End panels are veneer faced and backed on 3/8" MDF, using plain sliced veneer. Doweled joints; spring tension track system; smooth, nonbinding operation.

Available in Red Oak, Cherry, Maple or Alder.

17" W x 18-1/2" H x 11-7/8" D.

Fits standard 24" corner.

PART #	FINISH
AG-100-C-RO	Red Oak
AG-100-C-CH	Cherry
AG-100-C-MP	Maple
AG-100-C-AL	Alder



STRAIGHT UNIT

Appliance garage with solid wood tambour door mounted to solid wood face frame. End panels are veneer faced and backed on 3/8" MDF, using plain sliced veneer. Doweled joints; spring tension track system; smooth, nonbinding operation.

Available in Red Oak, Cherry, Alder or Maple.

24" W x 18-1/2" H x 11-7/8" D.

PART #	FINISH
AG-100-S-RO	Red Oak
AG-100-S-CH	Cherry
AG-100-S-MP	Maple
AG-100-S-AL	Alder



Above styles are available in White on a custom order basis - please inquire.

DOOR AND TRACK COMBO KITS

Set includes quality tambour door with handpull and spring tension track system packed together. 1275 series solid tambour door and ST-2 series spring tension track in Almond. Also available with 400 series wood veneer door, please inquire.

Door W: 15" or 24" x **H** 18". **Track H:** 17-1/2".

- Make your own appliance garage using these combo kits.



- * ST-3- series track available for frameless cabinets - please inquire.
- * White track available - please inquire.

SOLID WOOD DOOR SETS

PART #	FINISH	SIZE
C2-1518S-RO	Red Oak	15" x 18"
C2-1518S-MP	Maple	15" x 18"
C2-1518S-CH	Cherry	15" x 18"
C2-2418S-RO	Red Oak	24" x 18"
C2-2418S-MP	Maple	24" x 18"
C2-2418S-CH	Cherry	24" x 18"

**See page 558
for Tambour Sheets**

SPRING TENSION TRACK KITS

Size: Designed for doors 19" High x .220 Thickness

ST2 FACE FRAME MOUNT

- Kit includes plastic guide rails which can be stapled or screwed to face frame.

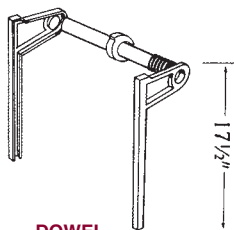

APPLICATION:



PART #	COLOR	DOWEL WIDTH
ST2-16-WH	White	16"
ST2-16-AL	Almond	16"
ST2-24-WH	White	24"
ST2-24-AL	Almond	24"
ST2-30-WH	White	30"
ST2-30-AL	Almond	30"
ST2-36-WH	White	36"
ST2-36-AL	Almond	36"

Material: PVC

ST3 EURO STYLE FRAMELESS MOUNT

- Kit includes plastic guide rails which are recessed or flush mounted to end panels of frameless cabinet.

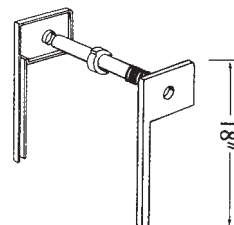

APPLICATION:

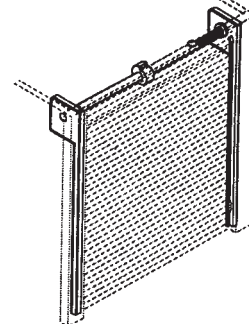

PART #	COLOR	DOWEL WIDTH
ST3-30-AL	Almond	30"
ST3-36-AL	Almond	36"

WINE RACK LATTICE

SOLID NORTH AMERICAN HARDWOOD WINE RACK LATTICE

- Available in 3 sizes - may be easily cut to desired size.
- Produced from 3/4" thick x 7/16" wide mouldings with radius edges. Glued and mechanically fastened at joints.
- Packaged and sold in pairs.
- Available in four unfinished solid woods (Red Oak, Maple, Cherry & Alder).
- Bottle openings are 4" x 4" (nominal).
- Best cut with a band saw.

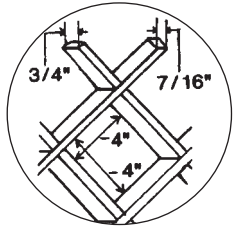

PART #	FINISH	BOTTLE CAPACITY	SIZE
SWWR2430-RO	Red Oak		24" x 30"
SWWR2430-MP	Maple	Holds	24" x 30"
SWWR2430-CH	Cherry	18 bottles	24" x 30"
SWWR2430-AL	Alder		24" x 30"
SWWR1736-RO	Red Oak		17" x 36"
SWWR1736-MP	Maple	Holds	17" x 36"
SWWR1736-CH	Cherry	14 bottles	17" x 36"
SWWR1736-AL	Alder		17" x 36"
SWWR2443-RO	Red Oak		24" x 43"
SWWR2443-MP	Maple	Holds	24" x 43"
SWWR2443-CH	Cherry	28 bottles	24" x 43"
SWWR2443-AL	Alder		24" x 43"

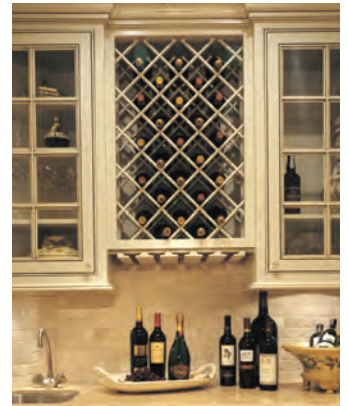

PREMIUM WINE RACK LATTICE

- Available in 3 sizes - may be easily cut to desired size.
- Premium routed panels produced from 11/16" x 11/16" hardwood mouldings. Glued and mechanically fastened at joints.
- Packaged and sold in pairs: Only front panels are routed.
- Available in three unfinished solid woods (Red Oak, Maple & Cherry).
- Bottle openings are 4-1/4" x 4-1/4" (nominal).

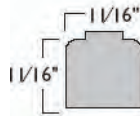

PART #	FINISH	BOTTLE CAPACITY	SIZE
PWRL2430-RO	Red Oak		24" x 30"
PWRL2430-MP	Maple	Holds	24" x 30"
PWRL2430-CH	Cherry	18 bottles	24" x 30"
PWRL1736-RO	Red Oak		17" x 36"
PWRL1736-MP	Maple	Holds	17" x 36"
PWRL1736-CH	Cherry	14 bottles	17" x 36"
PWRL2443-RO	Red Oak		24" x 43"
PWRL2443-MP	Maple	Holds	24" x 43"
PWRL2443-CH	Cherry	28 bottles	24" x 43"

STEMWARE RACK

Red Oak, Cherry, Maple or Alder

PART #	FINISH	SIZE
SR-18-RO	Red Oak	18" L
SR-18-CHY	Cherry	18" L
SR-18-MP	Maple	18" L
SR-30-RO	Red Oak	30" L
SR-30-CH	Cherry	30" L
SR-30-MP	Maple	30" L
SR-30-ALD	Alder	30" L
SR-36-RO	Red Oak	36" L
SR-36-CH	Cherry	36" L
SR-36-MP	Maple	36" L
SR-36-ALD	Alder	36" L

Solid wood, fully sanded and ready to finish. Accommodates most stemware styles.

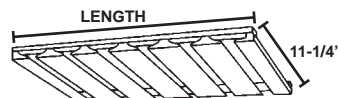

BOTTLE RACK

Red Oak, Maple or Cherry

- Available In 48" Lengths
- Unfinished Wood
- Holds 11 Bottles
- Each Piece Is Approximately 2" Tall & 3/4" Thick



PART #	FINISH
BR-48-OAK	Oak
BR-48-MP	Maple
BR-48-CH	Cherry

STEMWARE & WINE RACK COLLECTION



MATERIAL:

- Steel

PRODUCT FEATURES:

- Styles available for stemware and wine bottles
- Maximize space and easy access
- Heavy gauge wire provides elegance and durability

Finishes Available:

Chrome (CR), Satin Nickel (SN), Brass (BR) & Oil Rubbed Bronze (ORB)



Chrome Satin Nickel Brass Oil Rubbed Bronze

DESCRIPTION	PART NUMBER	DIMENSIONS	FINISH
STEMWARE HOLDER	3150-11CR	4-1/4" W x 11" D x 1-1/2" H	Chrome
	3150-11SN	4-1/4" W x 11" D x 1-1/2" H	Satin Nickel
	3150-11BR	4-1/4" W x 11" D x 1-1/2" H	Brass
	3150-11ORB	4-1/4" W x 11" D x 1-1/2" H	Oil Rubbed Bronze
	3150-16CR	4-1/4" W x 16" D x 1-1/2" H	Chrome
	3150-16SN	4-1/4" W x 16" D x 1-1/2" H	Satin Nickel
	3150-16BR	4-1/4" W x 16" D x 1-1/2" H	Brass
	3150-16ORB	4-1/4" W x 16" D x 1-1/2" H	Oil Rubbed Bronze
	3150-18CR	4-1/4" W x 18" D x 1-1/2" H	Chrome
	3150-18SN	4-1/4" W x 18" D x 1-1/2" H	Satin Nickel
DOUBLE BOTTLE RACK	3250CR	4-1/4" W x 9" H x 5/8" Thick	Chrome
	3250SN	4-1/4" W x 9" H x 5/8" Thick	Satin Nickel
	3250BR	4-1/4" W x 9" H x 5/8" Thick	Brass
	3250ORB	4-1/4" W x 9" H x 5/8" Thick	Oil Rubbed Bronze
QUAD STEMWARE HOLDER	3450-11CR	17" W x 11" D x 1-1/2" H	Chrome
	3450-11SN	17" W x 11" D x 1-1/2" H	Satin Nickel
	3450-11BR	17" W x 11" D x 1-1/2" H	Brass
	3450-11ORB	17" W x 11" D x 1-1/2" H	Oil Rubbed Bronze



Quad Stemware Holder

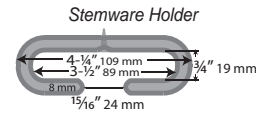

Stemware Holder



Stemware Holder

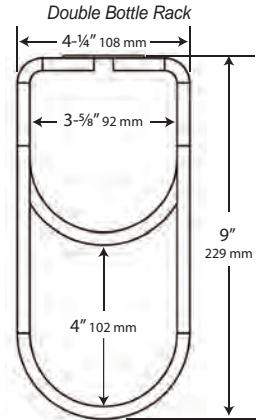

Double Bottle Rack



Double Bottle Rack

WINE RING GROMMETS

MATERIAL:

- High impact styrene

PRODUCT FEATURES:

- Overall dia. 4-1/2"

Colors Available:

White (WH), Black (BK)

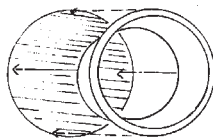
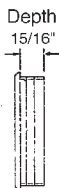
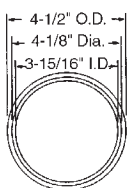
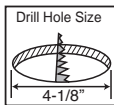

PART #	DRILL HOLE DIAMETER	COLOR
37WH	4-1/8"	White
37BK	4-1/8"	Black

STEMWARE HOLDER

MATERIAL:

- Acrylic

PRODUCT FEATURES:

- 8 ft. lengths
- Perfect for bars, kitchens, china cabinets & wall systems

Color Available:

Clear (CL)

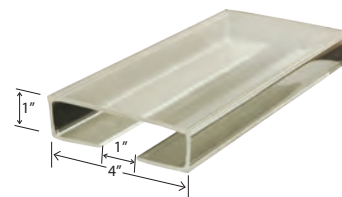

PART #
1120-CL