

2014



CEILING PRODUCTS

CEILING PRODUCTS

Pgs. 743-776



Beams
(Faux Wood)



Chandelier Light Lift



Corbels



designer's
edge
MILLWORK

CEILING
DOMES



ORAC DECOR

CEILING TILES



Steel



Plastic- Thermoplastic PVC



Light Diffuser
Ceiling Panels
(MirrorFlex™)

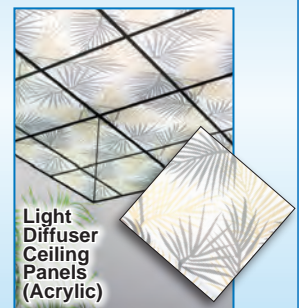

Light Diffuser
Ceiling Panels
(Acrylic)

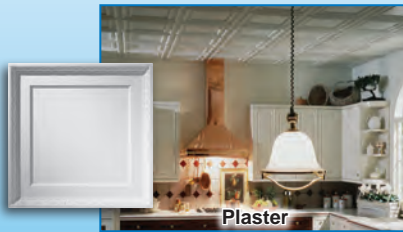

Plaster



High Density Polyurethane



Plastic- Laminated Rigid Vinyl

BEAM ACCESSORIES

Polyurethane Flat Plates	750
Polyurethane U-Brackets.....	743, 745-747, 749-751
Rubber Beam Strapping.....	743, 744, 747, 748
Touch Up Stain	743, 744, 747

BEAMS (FAUX WOOD)

Box Beam Collection	
Classic Raised Grain Box Beam	752
New World Box Beam	752
Vintage Box Beam.....	752

Contemporary Beam Collection

Classic Raised Grain	748
Mesa.....	749
Milled Style	749
Modern	747
New World.....	750
Rough Sawn.....	751

Rustic Beam Collection

Colonial Log.....	744
Hand Hewn.....	743
Old World.....	745
Tahoe.....	746
Vintage	744
Unfinished Beam Program	753

CEILING & WALL ORNAMENTS

Polyurethane Non-Textured Ornaments.....	769
--	-----

CEILING DOMES

Fiberglass	
Recessed w/Elliptical Plain Cove	773
Recessed w/Light Cove.....	773
Recessed w/Optional Trim.....	773
Recessed w/Round Bow & Swag Cove.....	773
Recessed w/Round Plain Cove.....	773
Recessed.....	772

High Density Polyurethane	
Recessed.....	770-771, 774
Surface Mount.....	771, 774

CEILING MEDALLIONS718-721

CEILING TILE ACCESSORIES

Cone Head Nails	756
Decorative Grid Strip	764
Decorative Grid Tape.....	764
Hold Down Clips.....	756
Matching Grid Covers.....	761

CEILING TILES

Cornices	
Recycled Steel Cornices	758
Stamped Steel Cornices.....	758

Filler Panels

Steel Fillers & Finished.....	756-757
Versa Tile High Density Polyurethane	765

High Density Polyurethane Ceiling Tiles	
Versa Tile.....	765

Light Diffuser Ceiling Panels

Acrylic.....	767
MirroFlex™	768

Plaster Ceiling Tiles

Commercial Suspended Ornamental	766
---------------------------------------	-----

Plastic Ceiling Tiles

Laminated Rigid Vinyl.....	762-764
Thermoplastic PVC.....	759-761

Steel Ceiling Tiles

Premium Finished.....	754-756
Premium Steel.....	754-756

Recycled Unfinished Steel.....	757
Steel Coffered.....	756

CHANDELIER LIGHT LIFT.....775

CORBELS

Contemporary Beam Collection

Classic Raised Grain	748
Mesa.....	749
Modern	747
New World.....	750
Rough Sawn.....	751

Rustic Beam Collection

Hand Hewn.....	743
Vintage	744

PANELS

Rustic Beam Collection

Hand Hewn.....	746
----------------	-----

SEE PAGES 1007-1023 FOR A - Z INDEX

THE RUSTIC BEAM COLLECTION



* Closed on one end*

Hand Hewn Beam Series 13' Lengths



2 Finishes Available



Unfinished



Finished

Our **Rustic Beams** allow you to bring back that "Old World Style" and to any room with their rustic warmth and charm. These beams are lightweight and easy to install.

Rustic Beams were fallen logs, hewn into shape using a broad axe. Forging ahead and settling the new frontier, early settlers did not have access to mills and machinery. They shaped the beams used in their homes and business by hand, using their axes and small tools. This resulted in a beam with rugged texture and character.

PART #	WIDTH A	HEIGHT B	INSIDE WIDTH C	UPPER INSIDE WIDTH D
HH20-55*	5"	5"	3"	2-3/8"
HH30-85*	8"	5-1/8"	6"	6-1/4"
HH40-87*	7-1/2"	6-5/8"	5-3/8"	4-7/8"

* For unfinished add -UNF to the part number

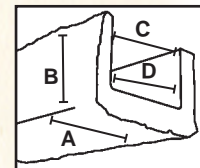

ACCESSORIES



CORBELS

HHCOR-120

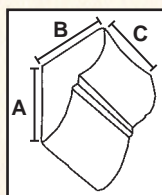

POLYURETHANE U-BRACKET

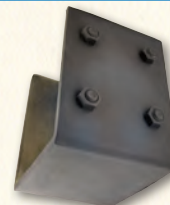

PART #	BOLTS PER SIDE	WORKS WITH	SIZE
HH20-BKT	4	HH20-55	5-1/2" H x 6-1/4" W x 3/8"
HH30-BKT	6	HH30-85	5-7/8" H x 9-1/4" W x 3/8"
HH40-BKT	6	HH40-87	7-7/8" H x 8-13/16" W x 3/8"

PART #	WORKS WITH	HEIGHT A	DEPTH B	WIDTH C
HHCOR-120	HH20-55	5-3/4"	4-1/16"	4-1/2"
HHCOR-120-U	HH20-55	5-3/4"	4-1/16"	4-1/2"
HHCOR-130	HH30-85 & HH40-87	9"	8-3/16"	6-3/4"
HHCOR-130-U	HH30-85 & HH40-87	9"	8-3/16"	6-3/4"

RUBBER BEAM STRAPPING

Single Strap
VINSTRAP

Double Strap
DB-STRAP

VINSTRAP (Black/Silver)
41" L x 1-1/2" W



DB-STRAP (Black/Silver)
42" L x 2-3/4" W



Due to photographic imaging, products may vary slightly in color. All sizes listed are approximate. Samples are available, please inquire.



3-1/2 oz.
TOUCH UP STAIN
HH-STAIN



THE RUSTIC BEAM COLLECTION



* Closed on both ends*

Vintage Beam Series

19' Lengths

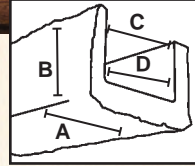

2 Finishes Available

PART #	WIDTH A	HEIGHT B	INSIDE WIDTH C	UPPER INSIDE WIDTH D
VINBEAM-50*	9"	9"	6"	6"
VINBEAM-60*	10"	12"	7-5/8"	7-5/8"
VINBEAM-70*	12"	15"	9"	9"

* For unfinished add -UNF to the part number



ACCESSORIES

VINTAGE CORBELS

VINCORBEL-5

VINCORBEL-10

VINCORBEL-15

VINCORBEL-20

VINCORBEL-25

VINCORBEL-30

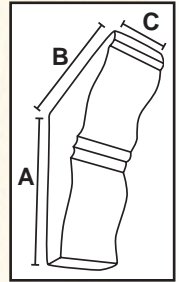

PART #	HEIGHT A	DEPTH B	WIDTH C
VINCORBEL-5*	18-1/8"	7"	4-3/4"
VINCORBEL-10*	18-5/8"	14"	6-5/8"
VINCORBEL-15*	18-1/2"	11"	6-5/8"
VINCORBEL-20*	10-5/8"	10-5/8"	6-1/2"
VINCORBEL-25*	12"	12"	7-5/8"
VINCORBEL-30*	21-1/4"	13-3/4"	9-1/2"

* For unfinished add -UNF to the part number

RUBBER BEAM STRAPPING

VINSTRAP

Single Strap
(Black/Silver)
41" L x 1-1/2" W



DB-STRAP

Double Strap
(Black/Silver)
42" L x 2-3/4" W



DB-70-STRAP

(Black)
(For VINBEAM-70)
44-1/2" L x 6" W

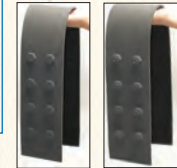

3-1/2 oz.
Touch-up Stain for
Vintage Beams
VINSTAIN

Due to photographic imaging, products may vary slightly in color.
All sizes listed are approximate. Samples are available, please inquire.



* Closed on both ends*

Colonial Log Beam Series

13' 9" Lengths



Finishes Available

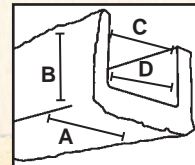

PART #	WIDTH A	HEIGHT B	INSIDE WIDTH C	UPPER INSIDE WIDTH D
CLB-76	7-1/2"	6-1/4"	4-1/8"	3-1/2"

THE RUSTIC BEAM COLLECTION



Old World Beam Series 16' & 20' Lengths

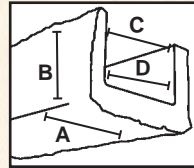

2 Finishes Available



Unfinished



Finished

PART #	WIDTH A	HEIGHT B	INSIDE WIDTH C	UPPER INSIDE WIDTH D	LENGTH
OWB-44*	4-1/2"	4-1/2"	2"	2"	16'
OWB-57*	5-1/4"	7-1/4"	3-3/8"	3-3/8"	20'
OWB-76*	7"	6-1/2"	4-1/4"	4-1/4"	16'
OWB-79*	7-1/4"	9"	4-1/4"	4-1/4"	20'
OWB-1513*	15-1/4"	13"	12"	12"	16'

* For unfinished add -UNF to the part number

ACCESSORIES



POLYURETHANE U-BRACKET



PART #	DESCRIPTION
OWB-U-44	4" W U-Bracket
OWB-U-57	5" W U-Bracket
OWB-U-76	5" W U-Bracket
OWB-UF-76	Flange - Bracket
OWB-U-79	6" W U-Bracket
OWB-UF-79	Flange - Bracket
OWB-U-1513	10" W U-Bracket
OWB-UCH-1513	Chevron Bracket

Due to photographic imaging, products may vary slightly in color.
All sizes listed are approximate. Samples are available, please inquire.



THE RUSTIC BEAM COLLECTION



** Open on both ends**

Tahoe Beam Series

19' 6" Lengths



PART #	WIDTH A	HEIGHT B	INSIDE WIDTH C	UPPER INSIDE WIDTH D
BMT8X10X234S	7-7/32"	8-31/32"	4-15/16"	4-1/4"

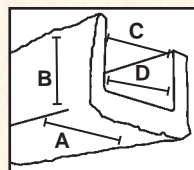

Finishes Available



Unfinished

ACCESSORIES



POLYURETHANE U-BRACKET



PART #	SIZE
BMSTRPT8X10	9-5/8" H x 8-3/8" W x 6" D



** Closed on both ends**

Hand Hewn Panels

130" Lengths



Our **Hand Hewn Panels** can be used for ceiling planking and rustic trim work throughout your decor.

PART #	WIDTH A	HEIGHT B
HH-PANEL-6	6-5/8"	1-1/4"
HH-PANEL-9	9"	2"
HH-PANEL-11	11"	2"

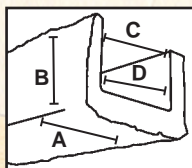

Finishes Available



Finished

Due to photographic imaging, products may vary slightly in color. All sizes listed are approximate. Samples are available, please inquire.

THE CONTEMPORARY BEAM COLLECTION



Modern Beam Series 13' Lengths

Finishes Available



Finished

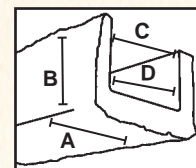

Our **Contemporary** offer a smooth milled appearance. Creating a sense of casual elegance adding visual interest with their clean lines.

PART #	WIDTH A	HEIGHT B	INSIDE WIDTH C	UPPER INSIDE WIDTH D
MOD-BEAM10	4-3/8"	2-1/4"	3"	2-3/4"
MOD-BEAM20	5-7/8"	3-7/8"	4-3/4"	4"
MOD-BEAM30	7-7/8"	5-7/8"	6-5/8"	4-1/2"

ACCESSORIES



CORBELS

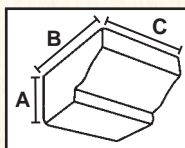

MOD-CORBEL10

PART #	HEIGHT A	DEPTH B	WIDTH C
MOD-CORBEL10	2-3/8"	4-3/4"	4-3/4"
MOD-CORBEL20	3-7/8"	6-1/8"	5-7/8"
MOD-CORBEL30	9-5/8"	12-5/8"	6-7/8"

POLYURETHANE U-BRACKET

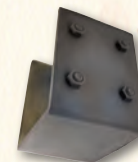

PART #	BOLTS PER SIDE	WORKS WITH	SIZE
MOD10-BKT	2	MOD-BEAM10	3" H x 7-7/8" W x 3/8"
MOD20-BKT	4	MOD-BEAM20	4-1/2" H x 7-7/8" W x 3/8"
MOD30-BKT	6	MOD-BEAM30	6-1/4" H x 10-1/4" W x 3/8"

RUBBER BEAM STRAPPING

Single Strap
VINSTRAP
Double Strap
DB-STRAP



VINSTRAP (Black/Silver)
41" L x 1-1/2" W

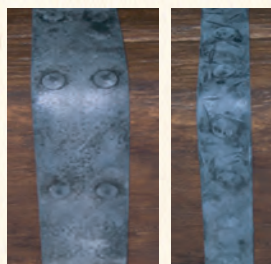

DB-STRAP (Black/Silver)
42" L x 2-3/4" W



3 oz. can of stain for touch ups
on Modern & Classic Raised
Grain Beams

MOD-BEAM-STAIN



Due to photographic imaging, products may vary slightly in color. All sizes listed are approximate. Samples are available, please inquire.

THE CONTEMPORARY BEAM COLLECTION



Classic Raised Grain Beam Series

16' & 19' Lengths

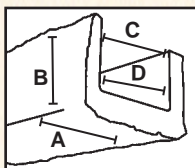

PART #	WIDTH	HEIGHT	INSIDE	UPPER INSIDE	LENGTH
	A	B	WIDTH C	WIDTH D	
CRB-54*	5-1/8"	4"	3-3/4"	3-3/4"	16'
CRB-66*	6"	6"	4-1/4"	4-1/4"	19'
CRB-810*	8"	10"	6-1/2"	6-1/2"	19'
CRB-86*	8-1/8"	6"	6-1/8"	6-1/8"	16'

* For unfinished add -UNF to the part number

2 Finishes Available

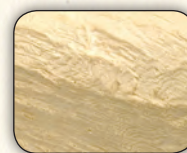

Unfinished

Finished

ACCESSORIES

CRB-54-COR

CORBELS

CRB-810-COR



CRB-66-COR

CRB-86-COR

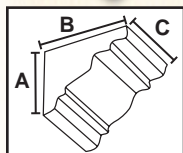
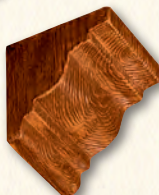

PART #	HEIGHT	DEPTH	WIDTH	WORKS
	A	B	C	WITH
CRB-54-COR*	5"	5"	4-1/2"	CRB-54
CRB-66-COR*	6"	6"	5-1/2"	CRB-66
CRB-86-COR*	5-3/4"	6"	7-1/4"	CRB-86
CRB-810-COR*	17-3/4"	11-3/4"	7-1/2"	CRB-810

* For unfinished add -UNF to the part number



RUBBER BEAM STRAPPING

VINSTRAP (Black/Silver)
41" L x 1-1/2" W

Single Strap
VINSTRAP

Double Strap
DB-STRAP

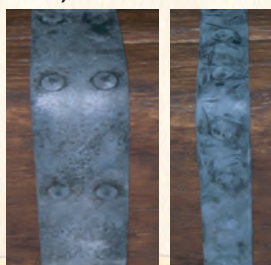

DB-STRAP (Black/Silver)
42" L x 2-3/4" W

Due to photographic imaging, products may vary slightly in color. All sizes listed are approximate. Samples are available, please inquire.

THE CONTEMPORARY BEAM COLLECTION



* Open on both ends*

Mesa Beam Series

12' & 19' 6" Lengths



PART #	WIDTH A	HEIGHT B	INSIDE WIDTH C	UPPER INSIDE WIDTH D	LENGTH
BMM6X8X144S	5-31/32"	7-17/32"	3-31/32"	3-3/4"	12'
BMM6X8X234S	5-31/32"	7-17/32"	3-31/32"	3-3/4"	19' 6"
BMM8X10X234S	7-1/4"	9"	4-31/32"	4-1/4"	19' 6"
BMM10X15X234S	9-1/8"	14-13/16"	6-21/32"	5-5/16"	19' 6"

Finishes Available

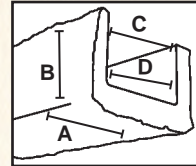

Unfinished

ACCESSORIES

CORBELS



COROG15X7S



COROGD15X7S



COROGA15X7S



COROGF15X7S

PART #	HEIGHT A	DEPTH B	WIDTH C
COROG15X7S	7-1/4"	14-1/2"	6"
COROGA15X7S	7-1/4"	14-1/2"	6"
COROGD15X7S	7-1/4"	14-1/2"	6"
COROGF15X7S	7-1/4"	14-1/2"	6"

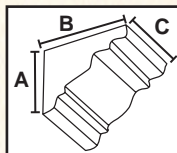

POLYURETHANE U-BRACKET



PART #	SIZE
BMSTRPM6X8	7-3/4" H x 7-1/16" W x 6" D
BMSTRPM8X10	9-5/8" H x 8-3/8" W x 6" D
BMSTRPM10X15	15-1/8" H x 10-1/4" W x 6" D



* Open on both ends*

Milled Style Beam Series

14' Lengths



PART #	WIDTH A	HEIGHT B
BMCDR4X3X168S	2-1/2"	3-1/2"
BMCDR8X6X168S	5-3/4"	7-1/4"

Finishes Available

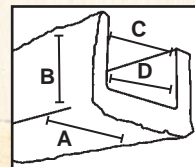

Unfinished

Due to photographic imaging, products may vary slightly in color.
All sizes listed are approximate. Samples are available, please inquire.

THE CONTEMPORARY BEAM COLLECTION



* Open on both ends*

New World Beam Series

56", 12', 14', 16', 20' & 22' Lengths

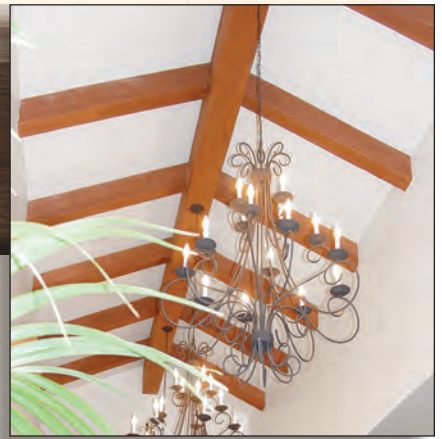

PART #	WIDTH A	HEIGHT B	INSIDE WIDTH C	UPPER INSIDE WIDTH D	LENGTHS
NWB-35*	3-1/2"	5-1/2"	1-1/8"	1-1/8"	22'
NWB-45*	4"	5-3/4"	2-1/8"	2-1/8"	16'
NWB-55*	5-1/2"	5-1/2"	2-5/8"	2-5/8"	20'
NWB-57*	5-1/2"	7-1/2"	3-3/8"	3-3/8"	20'
NWB-65*	6"	5"	3-1/2"	3-1/2"	20'
NWB-67*	6"	7-1/4"	3-1/2"	3-1/2"	12'
NWB-69*	6"	9"	3-1/8"	3-1/8"	56"
NWB-75*	7-3/4"	5-1/2"	6"	6"	14'
NWB-76*	7-1/2"	6-1/2"	5"	5"	20'
NWB-78*	6-1/2"	7-1/2"	4"	4"	20'
NWB-79*	7-1/4"	9-1/4"	4-1/8"	4-1/8"	20'
NWB-711*	7-1/4"	11"	4-3/8"	4-3/8"	20'
NWB-811*	8"	11-1/2"	4-7/8"	4-7/8"	14'
NWB-911*	9-1/4"	11"	6-1/2"	6-1/2"	20'
NWB-914*	9"	14-1/2"	6-3/4"	6-3/4"	20'
NWB-915*	9-1/2"	14-3/4"	6-3/4"	6-3/4"	14'
NWB-1114*	11-3/4"	14-3/4"	9"	9"	14'
NWB-1118*	11-1/2"	18-3/4"	8-1/4"	8-1/4"	16'
NWB-1515*	15-1/8"	15-1/8"	11-1/2"	11-1/2"	16'

* For unfinished add -UNF to the part number

2 Finishes Available



Unfinished



Finished

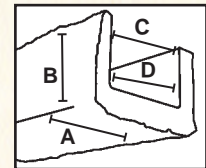

ACCESSORIES



Flat Plate

POLYURETHANE U-BRACKETS & FLAT PLATES



U-Bracket



CORBELS

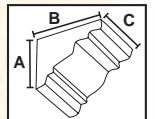

PART #	DESCRIPTION
NWB-FP-412A	Flat Plate: Nut Side 4" W x 12" L
NWB-FP-412B	Flat Plate: Bolt Side 4" W x 12" L
NWB-U-35	4" W U-Bracket
NWB-U-45	4" W U-Bracket
NWB-U-55	4" W U-Bracket
NWB-U-57	5" W U-Bracket
NWB-U-65	5" W U-Bracket
NWB-U-67	5" W U-Bracket
NWB-U-75	4" W U-Bracket
NWB-U-76	5" W U-Bracket
NWB-U-78	6" W U-Bracket
NWB-U-79	6" W U-Bracket
NWB-U-711	6" W U-Bracket
NWB-U-811	6" W U-Bracket
NWB-U-911	6" W U-Bracket
NWB-U-914	6" W U-Bracket
NWB-U-915	6" W U-Bracket
NWB-U-1114	8" W U-Bracket
NWB-U-1118	8" W U-Bracket
NWB-U-1515	8" W U-Bracket

PART #	HEIGHT A	DEPTH B	WIDTH C
NWB-COR-7818	8"	18"	7-1/4"
NWB-COR-7830	7-1/4"	30"	7-1/4"
NWB-COR-8612	6"	12"	8"
NWB-COR-8818	8"	18-1/4"	7-3/4"
NWB-COR-11818	8"	18-1/4"	11-3/4"
NWB-COR-161824	18"	24"	16"
NWB-COR-121630	16"	30"	12"
NWB-COR-7924	9-1/4"	24"	7-1/4"
NWB-COR-9924	9-1/4"	24"	9-1/4"
NWB-COR-7948	9-1/4"	48"	7-1/4"
NWB-COR-3514	5-1/2"	14"	3-1/2"
NWB-COR-7728	7-3/8"	28-3/8"	7-3/8"
NWB-COR-5917	9-1/4"	17-3/4"	5-1/4"
NWB-COR-52322	23"	22-3/4"	5-7/8"
NWB-COR-71624	16"	24"	7-3/8"
NWB-COR-71833	18-1/2"	33-3/4"	7-1/4"

Due to photographic imaging, products may vary slightly in color. All sizes listed are approximate. Samples are available, please inquire.

THE CONTEMPORARY BEAM COLLECTION

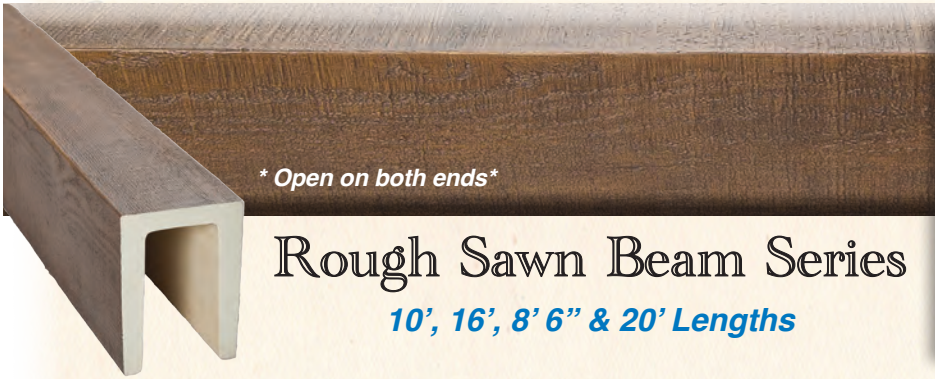

* Open on both ends*

Rough Sawn Beam Series

10', 16', 8' 6" & 20' Lengths



2 Finishes Available



Unfinished



Finished

PART #	WIDTH	HEIGHT	INSIDE	UPPER INSIDE	LENGTHS
	A	B	WIDTH C	WIDTH D	
RSB-33*	3-3/4"	3"	2-1/4"	2-1/4"	20'
RSB-34*	3-1/2"	4-1/2"	1-3/4"	1-3/4"	20'
RSB-57*	5-1/4"	7"	3-1/2"	3-1/2"	16'
RSB-511*	5-1/4"	11"	3-1/4"	3-1/4"	8' 6"
RSB-77*	7-1/2"	7-1/2"	5-7/8"	5-7/8"	20'
RSB-88*	8-1/2"	8-1/2"	6-1/2"	6-1/2"	10'
RSB-815*	8-1/2"	15-1/4"	6-3/8"	6-3/8"	10'

* For unfinished add -UNF to the part number

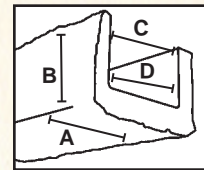

ACCESSORIES

CORBELS

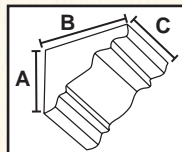

PART #	HEIGHT	DEPTH	WIDTH
	A	B	C
RSB-COR-5917	9-1/4"	17-3/4"	5-1/4"
RSB-COR-71130	11-1/2"	30"	7-1/4"
RSB-COR-7924	9-1/2"	24"	7-1/4"
RSB-COR-61612	16"	12"	6-3/4"



Due to photographic imaging, products may vary slightly in color. All sizes listed are approximate. Samples are available, please inquire.

POLYURETHANE U-BRACKET

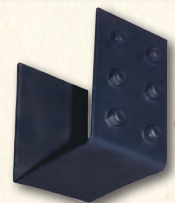

PART #	DESCRIPTION
RSB-U-33	4" W U-Bracket
RSB-U-34	4" W U-Bracket
RSB-U-57	5" W U-Bracket
RSB-U-511	5" W U-Bracket
RSB-U-77	6" W U-Bracket
RSB-U-88	6" W U-Bracket
RSB-U-815	6" W U-Bracket



Vintage Box Beam Series

1 Piece / 11' 6" Lengths

Our **Box Beams** are ideal for applications where all 4 sides of the beam can be viewed, such as cross beams in a room with cathedral ceilings and rooms with balconies.

For VINSTRAP & DB-STRAP See Page 748

PART #	WIDTH	HEIGHT
	A	B
VINBOXB-66	6"	6"

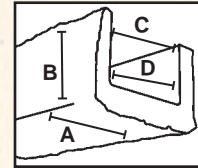

Finishes Available



Finished



Classic Raised Grain Beam Series

1 Piece / 11' 6" Lengths

For VINSTRAP & DB-STRAP See Page 748

PART #	WIDTH	HEIGHT
	A	B
CRBOXB-66	6"	6"

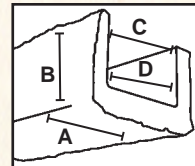

Finishes Available

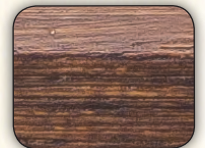

Finished



New World Beam Series

2 Pieces: 3 Sides + Cap / 20' Lengths

Allows installation around an existing item.

PART #	WIDTH	HEIGHT
	A	B
NWBOXB-22	2-1/2"	2-1/2"
NWBOXB-55*	5-1/2"	5-1/2"
NWBOXB-711*	7-1/4"	11"

★ Comes in 1 piece.

* For unfinished add -UNF to the part number

2 Finishes Available



Unfinished



Finished

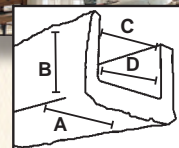

Due to photographic imaging, products may vary slightly in color. All sizes listed are approximate. Samples are available, please inquire.

Unfinished Beam Program

Create your own color

Simply make your selection from the many gel stain finishes that best suits your room.

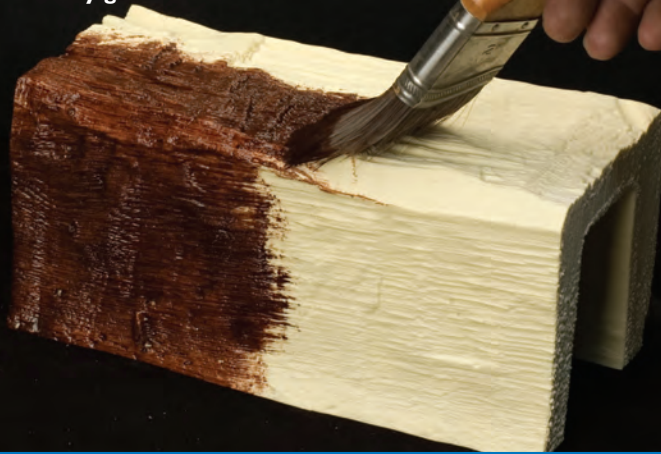

Brush on your stain and enjoy the Beauty

Why limit your choices of color?

Sample piece
Approx. 6"-8"



MINWAX GEL STAIN

One can of MINWAX Gel Stain will stain approximately 5 to 8 Beams (13 ft. beams).



Visit your Home Centers for endless color selections

Hint:
Water Base Gel Stains have a low gloss (flat) appearance.

Exterior Use:

It is Recommended when BEAMS are used for Entrance Ways or Over Terraces that an outdoor deck stain is applied.

- High Density Polyurethane.
- Light weight & Easy to install.
- Coordinating corbels and accessories available.
- Virtually impossible to distinguish from real wood.
- Will not rot, warp, decay or split.
- Our beams can be used indoors and outdoors. When using outdoors, a UV coating must be applied to prevent the pre-finished product from fading over time.

EASY INSTALLATION

Instructions:

1. Secure a wood block to the ceiling every 4-5 ft.
2. Slide the opening of the beam over the wooden blocks.
3. Place a line of silicone caulk on the beam.
4. Attach two screws/nails to the side of the beam. This will secure the beam to the ceiling.

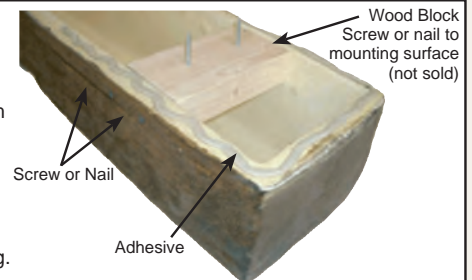

PREMIUM DECORATIVE STAMPED STEEL CEILING PANELS

Our New Stamped Ceiling Panels are an exciting interior mix of texture and nostalgia. Patterns drawn from the past enliven contemporary and traditional styling with their finely crafted detail.

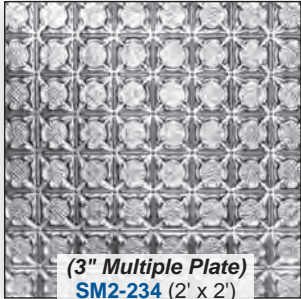

(3" Multiple Plate)
SM2-234 (2' x 2')
SM4-234 (2' x 4')

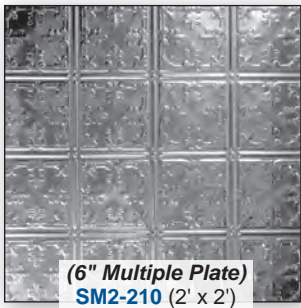

(6" Multiple Plate)
SM2-210 (2' x 2')
SM4-210 (2' x 4')

- Lightweight, non-combustible panels and accessories are manufactured from tin free steel 30 gauge, .010 thick.
- Chromium treated for superior paint retention.
- When material is properly coated, little or no maintenance is required and cleans with soap and water.
- Ceiling panels and cornices are shipped uncoated to allow custom on-site finishing.
- To prevent corrosion, panel must be coated.
- Recommended paints are RUST-O-LEUM to maintain the natural metal appearance, semi-gloss or high gloss oil base paints.
- **DO NOT USE WATER-BASED PAINT.**
- **HEAVY DUTY SAFETY GLOVES SHOULD BE WORN WHEN HANDLING PANELS AND CORNICES - EDGES ARE EXTREMELY SHARP.**
- **DUE TO PRODUCTION DYE LOTS, FINISH MAY VARY ON COLORED TILES & CORNICES.**

CUSTOM ORDERS
• If acoustics are a concern, all 2' x 2' tiles are available perforated. Custom order - 6 week lead time.

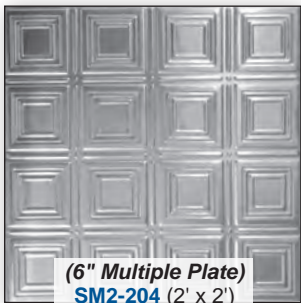

(6" Multiple Plate)
SM2-204 (2' x 2')
SM4-204 (2' x 4')

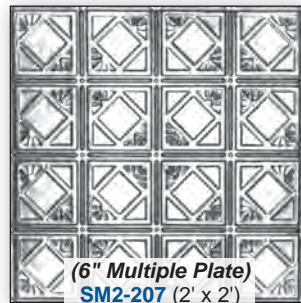

(6" Multiple Plate)
SM2-207 (2' x 2')
SM4-207 (2' x 4')

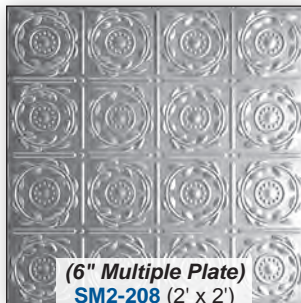

(6" Multiple Plate)
SM2-208 (2' x 2')
SM4-208 (2' x 4')

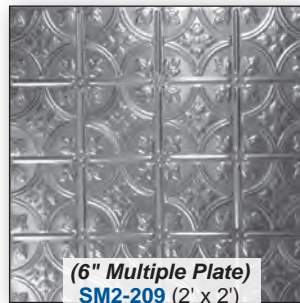

(6" Multiple Plate)
SM2-209 (2' x 2')
SM4-209 (2' x 4')

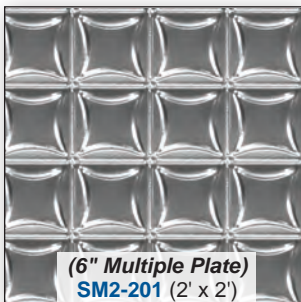

(6" Multiple Plate)
SM2-201 (2' x 2')
SM4-201 (2' x 4')

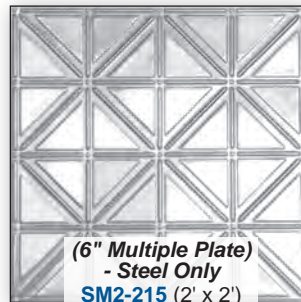

(6" Multiple Plate) - Steel Only
SM2-215 (2' x 2')
SM4-215 (2' x 4')

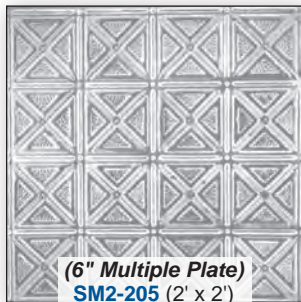

(6" Multiple Plate)
SM2-205 (2' x 2')
SM4-205 (2' x 4')

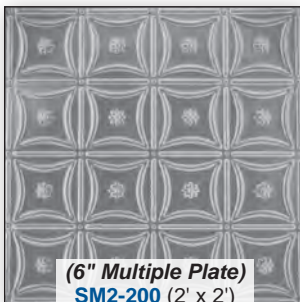

(6" Multiple Plate)
SM2-200 (2' x 2')
SM4-200 (2' x 4')

When ordering different finishes, please add the following to the end of the part #: Copper = C, Brass = B, Chrome = CH, White = WH, Lacquer = LAQ.

- PREMIUM**
- FINISH**
- Steel
 - Lacquered
 - White
 - Brass
 - Copper
 - Chrome

FINISHES AVAILABLE



All Brass, Copper, Chrome and White Panels and Cornices are shipped with a clear baked on enamel finish. Additional finishing is **NOT RECOMMENDED**.

PREMIUM DECORATIVE STAMPED STEEL CEILING PANELS

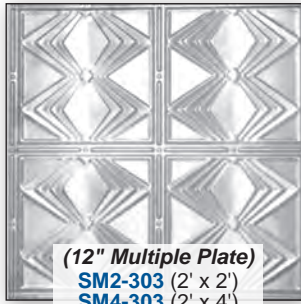

(12" Multiple Plate)
SM2-303 (2' x 2')
SM4-303 (2' x 4')

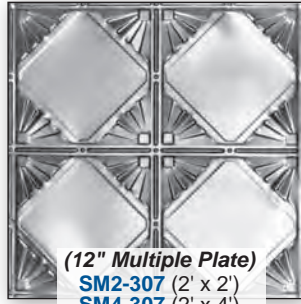

(12" Multiple Plate)
SM2-307 (2' x 2')
SM4-307 (2' x 4')

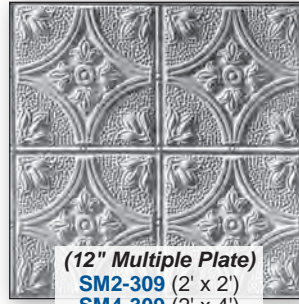

(12" Multiple Plate)
SM2-309 (2' x 2')
SM4-309 (2' x 4')

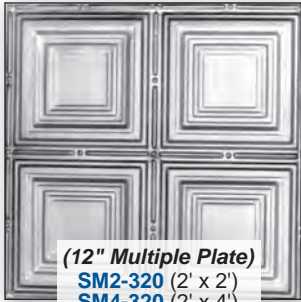

(12" Multiple Plate)
SM2-320 (2' x 2')
SM4-320 (2' x 4')

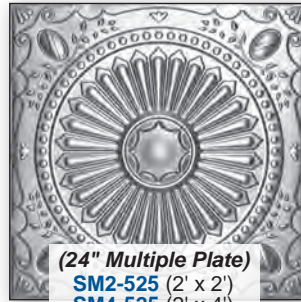

(24" Multiple Plate)
SM2-525 (2' x 2')
SM4-525 (2' x 4')

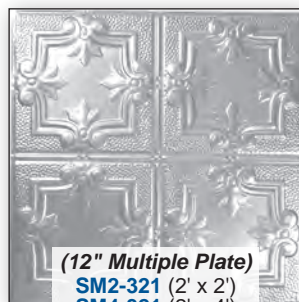

(12" Multiple Plate)
SM2-321 (2' x 2')
SM4-321 (2' x 4')

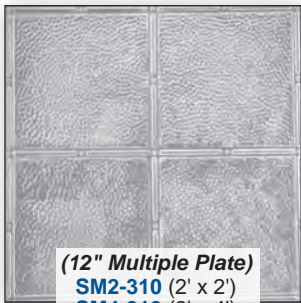

(12" Multiple Plate)
SM2-310 (2' x 2')
SM4-310 (2' x 4')

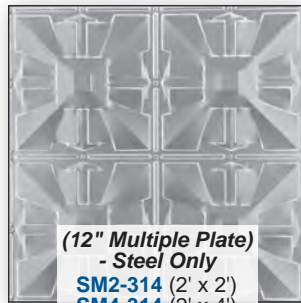

(12" Multiple Plate)
- Steel Only
SM2-314 (2' x 2')
SM4-314 (2' x 4')

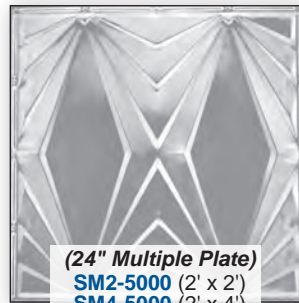

(24" Multiple Plate)
SM2-5000 (2' x 2')
SM4-5000 (2' x 4')

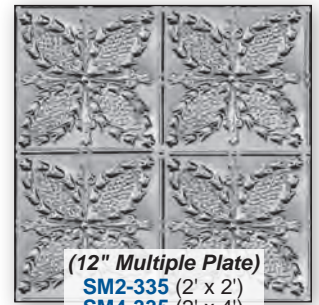

(12" Multiple Plate)
SM2-335 (2' x 2')
SM4-335 (2' x 4')



(24" Multiple Plate)
SM2-504 (2' x 2')
SM4-504 (2' x 4')

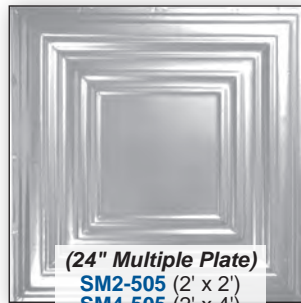

(24" Multiple Plate)
SM2-505 (2' x 2')
SM4-505 (2' x 4')

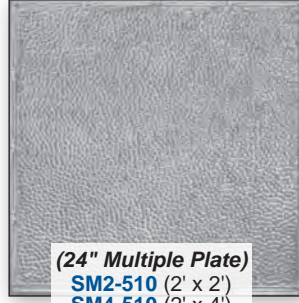

(24" Multiple Plate)
SM2-510 (2' x 2')
SM4-510 (2' x 4')



(24" Multiple Plate)
SM2-503 (2' x 2')
SM4-503 (2' x 4')



(24" Multiple Plate)
SM2-501 (2' x 2')
SM4-501 (2' x 4')

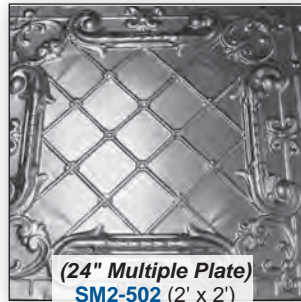

(24" Multiple Plate)
SM2-502 (2' x 2')
SM4-502 (2' x 4')

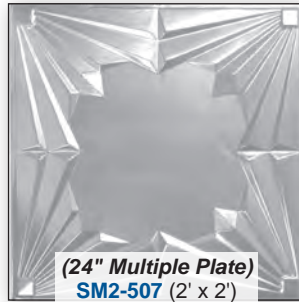

(24" Multiple Plate)
SM2-507 (2' x 2')
SM4-507 (2' x 4')

PREMIUM

When ordering different finishes, please add the following to the end of the part #: Copper = C, Brass = B, Chrome = CH, White = WH, Lacquer = LAQ.

FINISH

- Steel
- Lacquered
- White
- Brass
- Copper
- Chrome

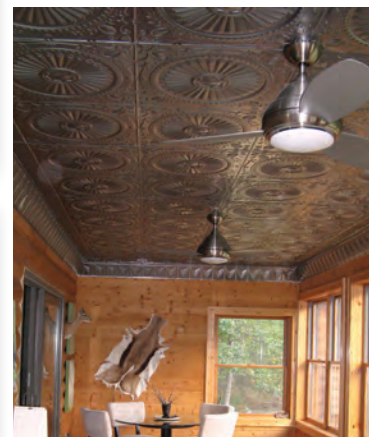

PREMIUM DECORATIVE STAMPED STEEL CEILING PANELS



(24" Multiple Plate)
SM2-509 (2' x 2')
SM4-509 (2' x 4')

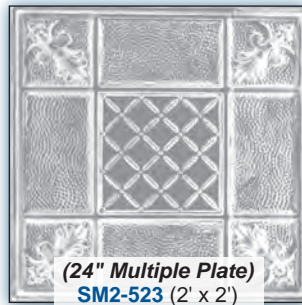

(24" Multiple Plate)
SM2-523 (2' x 2')
SM4-523 (2' x 4')



(24" Multiple Plate)
SM2-515 (2' x 2')
SM4-515 (2' x 4')

When ordering different finishes, please add the following to the end of the part #: Copper = C, Brass = B, Chrome = CH, White = WH, Lacquer = LAQ.

PREMIUM	FINISH
	Steel
	Lacquered
	White
	Brass
	Copper
	Chrome

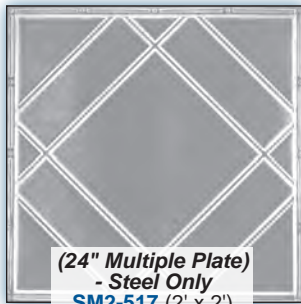

(24" Multiple Plate)
 - Steel Only
SM2-517 (2' x 2')
SM4-517 (2' x 4')



(24" Multiple Plate)
SM2-500 (2' x 2')
SM4-500 (2' x 4')

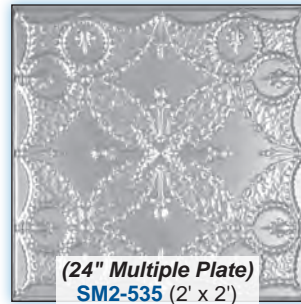

(24" Multiple Plate)
SM2-535 (2' x 2')
SM4-535 (2' x 4')

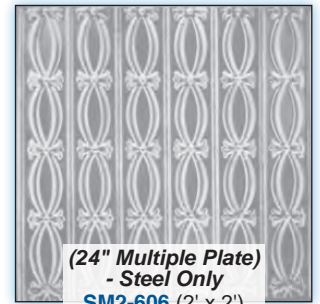

(24" Multiple Plate)
 - Steel Only
SM2-606 (2' x 2')
SM4-606 (2' x 4')

FILLERS

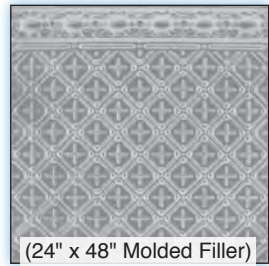

(24" x 48" Molded Filler)
SM4-4574

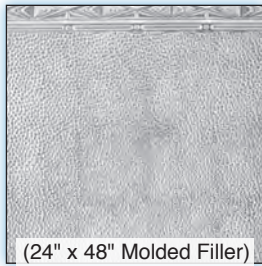

(24" x 48" Molded Filler)
SM4-5007

When ordering different finishes, please add the following to the end of the part #: Copper = C, Brass = B, Chrome = CH, White = WH.

ACCESSORIES

CONE HEAD NAILS

1-1/4" LONG
 1 LB. BOX
 Coverage approx.
 200 sq. ft. per box
 or (25) 4 ft. sections
 of cornice

HOLD DOWN CLIPS

200 PCS. PER BOX

PART

SM-CLIP

SM-NAIL - Steel -
SM-NAIL-B - Brass -
SM-NAIL-C - Copper -
SM-NAIL-CH - Chrome -
SM-NAIL-WH - White -
SM-PAINT - White spray paint for touch ups



24" x 24"

FOR THE LOOK OF A COFFERED CEILING:



A



B

2' x 4'

12" x 24"

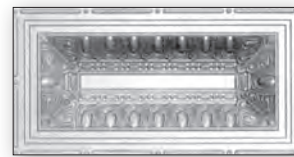

C

12" x 12"

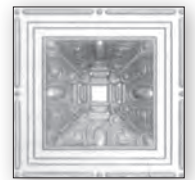

D

AVAILABLE IN 2' x 2' AND 2' x 4' NAIL-UP AND LAY-IN

LAY-IN

PART #	FINISH	DIMENSIONS
A SM-508	Steel	24" x 24" Plate, 1-1/2" Deep
B SM4-508	Steel	2' x 4'
C SM-508B	Steel	12" x 24" Plate, 1-1/2" Deep
D SM-508A	Steel	12" x 12" Plate, 1-1/2" Deep

NAIL-UP

PART #	FINISH	DIMENSIONS
A SM2-508-N	Steel	2' x 2'
B SM4-508-N	Steel	2' x 4'
C SM-508B-N	Steel	12" x 24" Plate, 1-1/2" Deep
D SM-508A-N	Steel	12" x 12" Plate, 1-1/2" Deep

COFFERED CEILING TILES ONLY AVAILABLE IN STEEL

RECYCLED UNFINISHED STEEL CEILING PANELS

**Build
Green**

**RECYCLED
UNFINISHED STEEL**

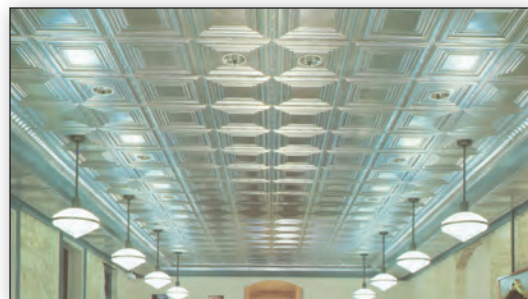
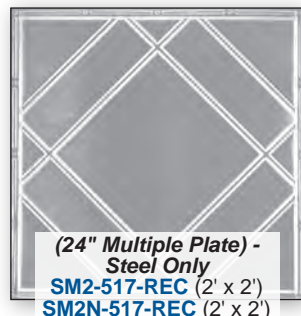
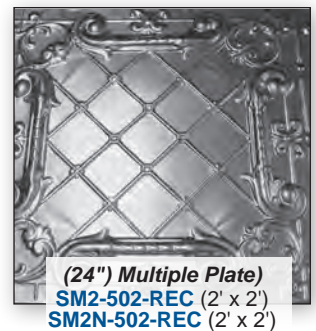
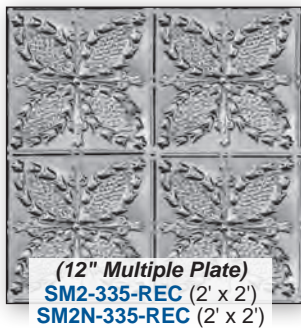
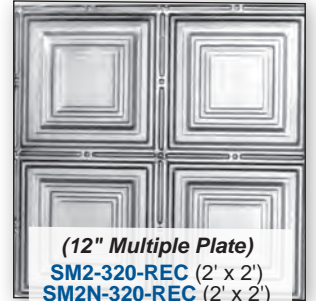
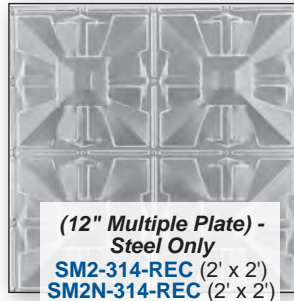
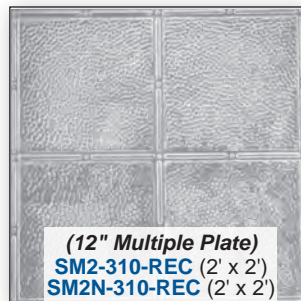
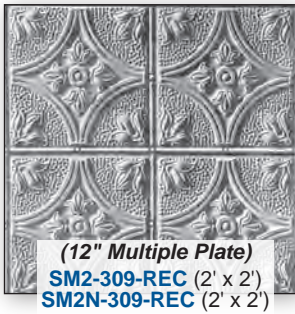
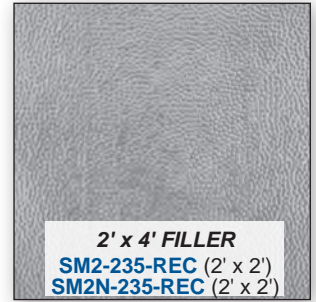
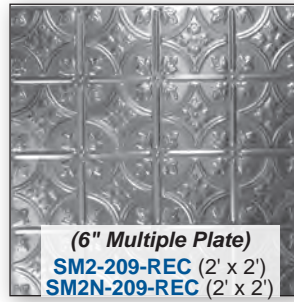
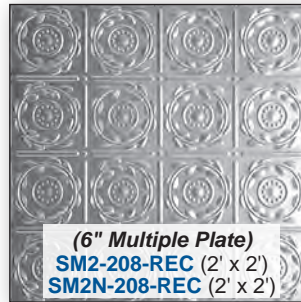
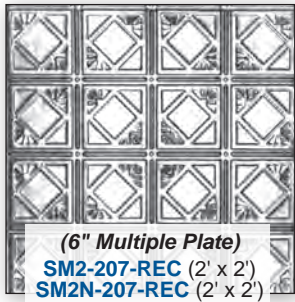
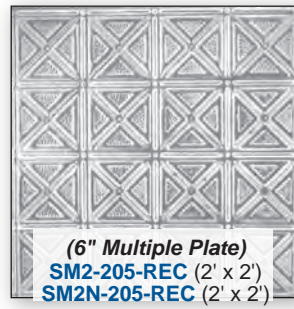
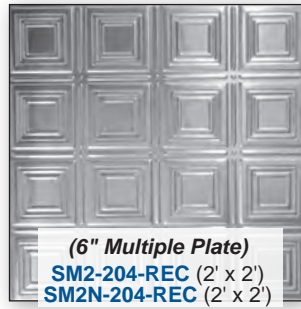
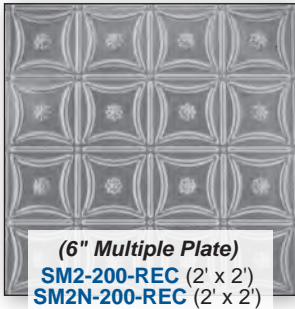

NOTE: This moulding is a right angle girder nosing.

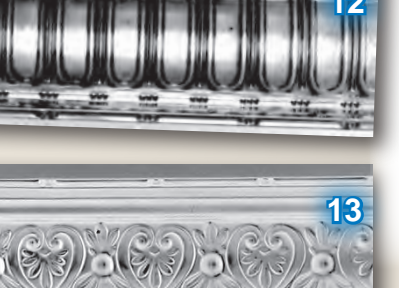
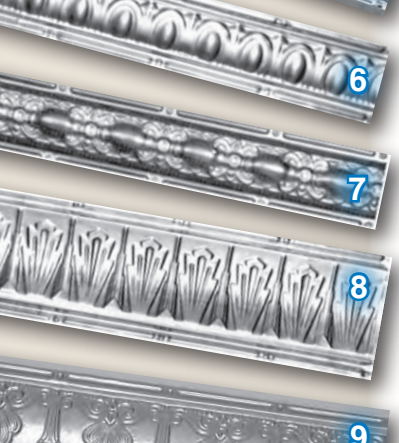

DECORATIVE STAMPED STEEL CORNICE

Available in 4 ft. lengths



	PART #	A	B	C
1	SM-800	1-1/2"	1-1/2"	1-1/2"
2	SM-810	2-5/8"	2"	2"
3	SM-803	3-1/2"	2-1/2"	2-1/2"
4	SM-801	3-5/8"	2-1/2"	2-1/2"
5	SM-909	3-1/2"	3"	3"
6	SM-802	4-1/2"	3-1/2"	3-1/2"
7	SM-804	4-1/2"	4"	4"
8	SM-905	7-1/4"	4"	4"
9	SM-705	6-1/2"	4"	4"
10	SM-904	7-1/4"	6"	6"
11	SM-906	9-1/4"	6"	6"
12	SM-806	9-1/4"	6"	6"
13	SM-707	9"	6-1/4"	6-5/8"
14	SM-808	11-1/4"	8-3/4"	8-3/4"
15	SM-807	13"	9-1/2"	9-1/2"
16	SM-706	14"	9"	9"
17	SM-907	15-5/8"	9"	9"

RECYCLED CORNICE

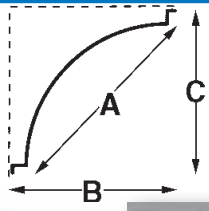

	PART #
2	SM-810-REC
6	SM-802-REC
9	SM-705-REC

When ordering different finishes, please add the following to the end of the part #: Copper = C, Brass = B, Chrome = CH, White = WH, Laquer = LAQ.



Don't Replace
RE-FACE



Thermoplastic PVC Ceiling Tiles
2' x 2' & 2' x 4'
.030" Thick Lay-In or Glue-Up Tiles

- A cost efficient and unique alternative to real metal
- **Class A Fire Rated**
- High Impact
- Chemical and scratch resistant properties



COMMERCIAL APPLICATION
LAY-IN TILE
Boston tile shown in
Cracked Copper finish

Our **Lay-In Tiles** are designed to install over existing tiles. They work with standard T-grid suspension systems. **It is recommended that a standard tile (old or new) be used on top of our 2' x 4' lay-in tiles to hold them in place.** The 2' x 2' size would produce no sag but the 2' x 4' might require a small amount of panel adhesive to eliminate this.

There are no special tools or skilled labor required for installation. In fact all tiles can be easily fabricated using a simple utility knife or scissors.

These extremely lightweight panels have an impervious waterproof surface, are mildew resistant and will not harbor germs or bacteria. They are low maintenance and can be washed with mild soap and water.

Do Not Use Abrasive Cleaners!
You will never have to replace again.



RESIDENTIAL APPLICATION
GLUE-UP TILE
Boston tile shown in
Cross Hatch Silver finish

Our **Glue-Up Tiles** are to be adhered directly to an existing ceiling. They are designed with an overlap system to make installation easy.

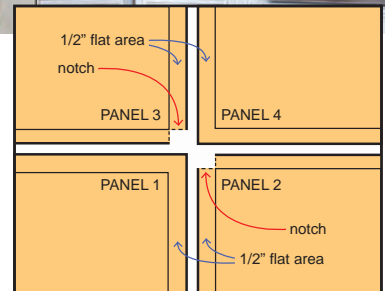

When overlapping four MirroFlex panels, it is necessary to cut a 1/2" notch in panels 2 and 3 to avoid a bulge where the panels meet.

CEILING TILES

Thermoplastic PVC Ceiling Tiles 2' x 2' & 2' x 4' .030" Thick Lay-In or Glue-Up Tiles

*ADD FINISH CODE TO END OF PART NUMBER
Example- **PCT22L-ROS-AS**

Finishes are shown on the next page

BALTIMORE

PCT22G-BAL* 2' x 2' Glue Up
PCT22L-BAL* 2' x 2' Lay In
PCT24G-BAL* 2' x 4' Glue Up
PCT24L-BAL* 2' x 4' Lay In



BOSTON

PCT22G-BOS* 2' x 2' Glue Up
PCT22L-BOS* 2' x 2' Lay In
PCT24G-BOS* 2' x 4' Glue Up
PCT24L-BOS* 2' x 4' Lay In



CHARLESTON

PCT22L-CHA* 2' x 2' Lay In
PCT24G-CHA* 2' x 4' Glue Up
PCT24L-CHA* 2' x 4' Lay In



COLONIAL

PCT22G-COL* 2' x 2' Glue Up
PCT22L-COL* 2' x 2' Lay In



GEORGIAN

PCT22G-GEO* 2' x 2' Glue Up
PCT22L-GEO* 2' x 2' Lay In



STRIKE *Formerly Hammered*

PCT22L-HAM* 2' x 2' Lay In
PCT24G-HAM* 2' x 4' Glue Up
PCT24L-HAM* 2' x 4' Lay In



MADISON

PCT22L-MAD* 2' x 2' Lay In
PCT24G-MAD* 2' x 4' Glue Up
PCT24L-MAD* 2' x 4' Lay In



QUADRO

PCT22L-QUA* 2' x 2' Lay In
PCT24L-QUA* 2' x 4' Lay In

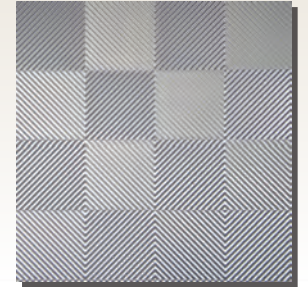

REGENCY

PCT22G-REG* 2' x 2' Glue Up
PCT22L-REG* 2' x 2' Lay In



ROSETTE

PCT22L-ROS* 2' x 2' Lay In
PCT24G-ROS* 2' x 4' Glue Up
PCT24L-ROS* 2' x 4' Lay In



SAHARA

PCT22L-SAH* 2' x 2' Lay In
PCT22G-SAH* 2' x 2' Glue Up



You can achieve a checkerboard effect by alternating between (vertical) and (horizontal) tiles. Please specify when ordering.

SAVANNAH

PCT22G-SAV* 2' x 2' Glue Up
PCT22L-SAV* 2' x 2' Lay In
PCT24G-SAV* 2' x 4' Glue Up
PCT24L-SAV* 2' x 4' Lay In



CEILING TILES

Thermoplastic PVC Ceiling Tiles 2' x 2' & 2' x 4' .030" Thick Lay-In or Glue-Up Tiles

CORE FINISHES

Lay-In or Glue-Up: 2' x 2'

Lay-In or Glue-Up: 2' x 4'

Core finishes available to ship normally within 3-5 business day

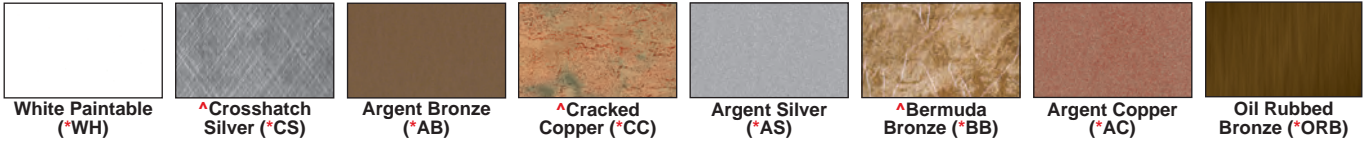

ALL OTHER FINISHES

**Lay-In or Glue-Up
2' x 2'**

**Lay-In or Glue-Up
2' x 4'**

All other finishes may have a minimum order requirement and extended lead time. Please inquire.



Argent finishes have color throughout so scratches are less visible. They are perfect for walls in high traffic areas.

^ Now available Tuffcote™ on selected finishes. A revolutionary protection shield that offers superior durability and scratch resistance.

MATCHING GRID COVER FOR CEILINGS



SNAP-ON COVER FOR 15/16" T-BAR SUSPENSION GRID SYSTEMS

- Low cost alternative to replacing or repainting rusted, stained, or deteriorated metal grid.
- Eliminates costly facility downtime from demolition and replacement.
- Easy, one-person installation.
- Works on 2' x 2' or 2' x 4' ceiling grid systems.
- High grade vinyl is easy to cut and work with.
- Main covers are pre-notched to provide seamless transitions at cross tee intersections.
- Components are factory cut to standard grid dimensions.

**FITS ANY
15/16" GRID
SYSTEM**



CORE FINISHES



NOTE: Also available in all other finishes. Minimums apply. Please inquire.

*ADD FINISH CODE TO END OF
PART NUMBER: Example- GM210-CC

PART #	DESCRIPTION
GM210-*	4' Main Cover
GM220-*	2' Tee Cover
GM230-*	4' Tee Cover
GM250-*	4' Wall Moulding Cover



Laminated Rigid Vinyl Ceiling Tiles
2 Ft. x 2 Ft.

.030" Thick Drop In, Glue or Staple Up Tiles (1" T-bar grid required for drop in)

Available in White/Paintable (*WTP), Tin/Pewter (*PBR), Copper (*CBR), or Bronze (*BBR)
Please specify color code when ordering

Enjoy a magnificent antique ceiling. Create the look of historical pressed metal for a fraction of the time and price.

Better Than Tin Ceiling Tiles!

Decorative reproductions of classic tin styles that turn any ceiling into a work of art.



Alexander Style

- ❖ Remarkable Value and Versatility
- ❖ Fully recyclable
- ❖ Greenguard certified for "Indoor Air Quality" and "Children & Schools"
- ❖ FDA compliant
- ❖ **Class A Fire Rated**



Fleur-De-lis Style



- **Won't absorb moisture or stain**
- **Won't harbor dust, mold or mildew**
- **Easy to install**

CEILING TILES



Laminated Rigid Vinyl Ceiling Tiles 2 Ft. x 2 Ft.

.030" Thick Drop In, Glue or Staple Up Tiles (1" T-bar grid required for drop in)

Available in White/Paintable (*WTP), Tin/Pewter (*PBR), Copper (*CBR), or Bronze (*BBR)
Please specify color code when ordering

Stock Styles Available:



V3-MAD-22-*
Madison *Coffered*
(recommended 5" clearance)
(shown in White)



V3-FLEUR-22-*
Fleur-De-Lis ■▲
(shown in Copper)



V3-CAMB-22-*
Cambridge
(shown in Tin)
Available In 2' x 4', Please Inquire

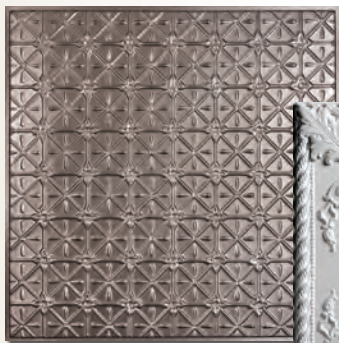

V3-CONT-22-*
Continental ■▲
(shown in Tin)



V3-ALEX-22-*
Alexander
(shown in White)



V3-EVANG-22-*
Evangeline
(shown in Bronze)



- Great for full-ceiling direct use, and as border tiles in drop ceiling applications.
- ▲ This tile may be trimmed and installed along ceiling borders.

CEILING TILES



Laminated Rigid Vinyl Ceiling Tiles 2 Ft. x 2 Ft.

.030" Thick Drop In, Glue or Staple Up Tiles (1" T-bar grid required for drop in)

Available in White/Paintable (*WTP), Tin/Pewter (*PBR), Copper (*CBR), or Bronze (*BBR)

Please specify color code when ordering

Decorative Tape & Strip



Decorative Grid Tape
1" x 100' rolls.
Approximately 1 roll per 20 tiles.
Grid mount installation only.

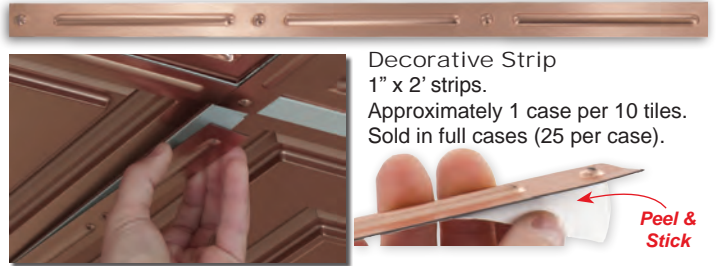

Decorative Strip
1" x 2' strips.
Approximately 1 case per 10 tiles.
Sold in full cases (25 per case).

PART #	FINISH
AC-DECOTAPE-WTP	White
AC-DECOTAPE-*	Others

PART #	FINISH
V3-DECOSTRP-WTP	White
V3-DECOSTRP-*	Others

Stock Styles Available:



V3-ORL-*



V3-BENT-*



V3-AVAL-*



V3-BELLA-*



V3-EMP-*



V3-JACK-*



V3-RAT-*



V3-BISTRO-*



- Great for full-ceiling direct use, and as border tiles in drop ceiling applications.
- ▲ This tile may be trimmed and installed along ceiling borders.

VERSATILE

THE CEILING SOLUTION

2 ft. x 2 ft. HIGH DENSITY POLYURETHANE

FILLER PANELS AVAILABLE

Versa Tile 2 ft. x 2 ft. are hand finished by skilled craftsmen resulting in a product that far surpasses the competition. Available in a variety of patterns.



CFP-WH (Primed White)
12" x 24" x 1/2" thick

CWP-WH (Primed White)
24" x 24" x 1/2" thick

ONE PANEL DOES IT ALL!



CP10F-WH (Primed White)

Use this side for 6" to 12" (x 24") openings Use this side for 3" to 5-7/8" (x 24") openings



- 12" x 24" double sided, decorative filler panel.
- For use on ceiling perimeter on less than full tile widths.
- Can be trimmed using standards carpentry tools to fit 3" to 12" (x 24") openings.

- Easier to install than plaster tiles.
- Ideal for cameo or specific highlighted areas.
- Highly insulated for savings on heating/cooling costs.
- Water and insect proof.
- Lifetime warranty against any manufacturing defects.
- Allows complete accessibility to all above ceiling utilities.

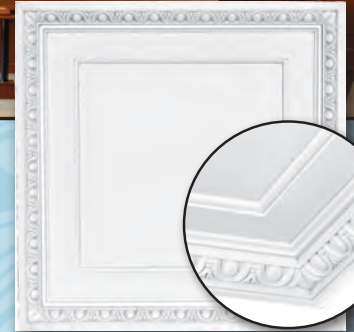

CP9-WH-SP (Primed White)
3" Projection



CP10-WH-SP (Primed White)
1.375" Projection

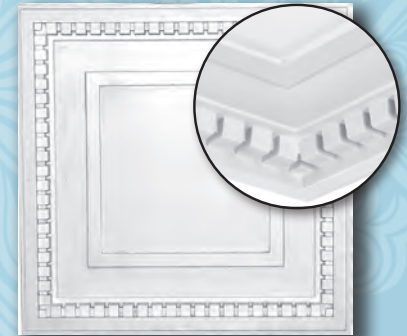

CP11-WH-SP (Primed White)
2" Projection



CP13-WH-SP (Primed White)
3.25" Projection



CP17-WH-SP (Primed White)
3" Projection



CP19-WH-SP (Primed White)
3" Projection

2' x 2' Polyurethane primed white drop in ceiling tiles ready to paint oil based preferred can use latex. Do not use lacquer based paint.

This product does not contain any mineral fibers, formaldehyde or cancer causing agents

COMMERCIAL SUSPENDED ORNAMENTAL PLASTER CEILING TILES

- 2 ft. x 2 ft. lay-in panels for use with standard commercial 15/16" T-bar suspension grid. Grid must be suspended by 12 gauge pre-straightened steel wire at 4 ft. on center.
- Cuts as easily as dry wall for down lights, sprinklers and vents.



- No need for hold down clips & no rattling in the grid.
- Tested in accordance with ASTM-E84. Results were zero smoke spread, zero flame spread and zero fuel contribution.

These tiles are composed of gypsum cement, glass fibers and other non combustible aggregates. All tiles are finished with a ceiling white satin latex. A nominal 1/2" thick, and consistently weigh only 2 - 2.25 lbs. per square ft. The tiles satisfy ASTM Spec.C-635 for L/360, based on hanger wire at 4' on center. The relief on the tiles varies from 1/4" - 3" according to the design.



24 pc. minimum

Class A Fire Rating;
will not sustain combustion
or release toxic fumes.

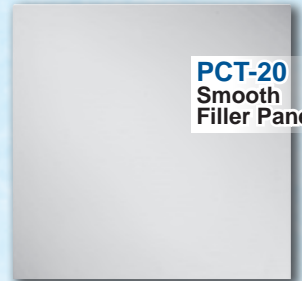
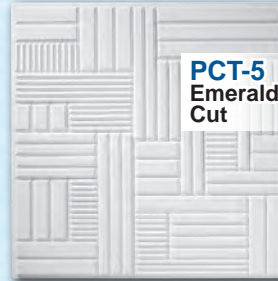
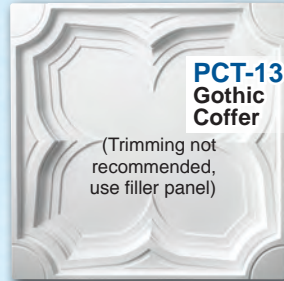
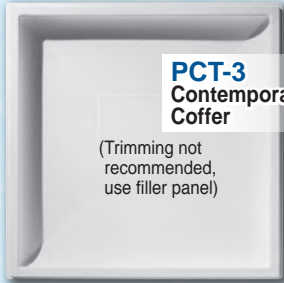

ACRYLIC CEILING PANELS

SIX DESIGNS • 2' x 2' or 2' x 4' x .080" TILES

Bring the look of the outdoors inside your home or business. These tiles transmit up to 70% of available light ensuring both a bright space, and high style!

- .080" thick non-yellowing acrylic.
- Environmentally responsible using 99.9% VOC-free inks and 100%  acrylic!
- High light transmission lens material.
- High impact resistance.
- Approximately 1/2 lb. per square foot.
- Use with fluorescent light sources. Best results are achieved with full spectrum lamps.
- Supplied with protective film on one side.

EASY TO INSTALL!

- Use existing grid systems.
- Panels drop right in.



Used with all warm white lamps

Summer Sky

Used with all cool white lamps



Green Elm Leaves



White Elm Leaves

PART #	SIZE	DESIGN
APSS-22	2' x 2'	Summer Sky
APSS-24	2' x 4'	Summer Sky
APWEL-22	2' x 2'	White Elm Leaves
APWEL-24	2' x 4'	White Elm Leaves
APGEL-22	2' x 2'	Green Elm Leaves
APGEL-24	2' x 4'	Green Elm Leaves
APTH-22	2' x 2'	Thatch
APTH-24	2' x 4'	Thatch
APPLW-22	2' x 2'	White Palm Leaves [^]
APPLTG-22	2' x 2'	Tan/Grey Palm Leaves [^]

[^]Available in 2' x 2' only

- Applications:
- Restaurants • Conference Rooms • Classrooms
 - Doctor's office • Waiting rooms • Home Decor



Thatch



White Palm Leaves



Tan/Grey Palm Leaves



See page 738 for additional Luminous Ceiling Tiles

MIRROFLEX™ LIGHT DIFFUSERS

MirroFlex™ Light Diffusers are designed to replace existing prismatic panels in suspended ceiling systems. Our diffusers are ideal for office work environments because the light is directed from side to side and does not shine downward onto computer stations.

The panels are tegular which means the embossed part of the design is lower than the suspension grid and the 4 edges are flat to fit nicely into the grid.

2' x 4' Sheets
(23-5/8" x 46-1/2")
Tolerance +/- 1/4"

.030"
Thickness

PRODUCT FEATURES:

- Thermoplastic Panels
- Finish: Frosted Clear
- **Class A Fire Rated**
- 30% more light at eye level.
- Brighter light around perimeter.
 - Softer light at desk height.
- Lightweight approximately 1.17 lbs each.

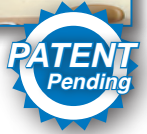

APPLICATIONS:

- Offices
- Hallways
- Schools
- Homes
- Medical Facilities



Wavation: LD24-WAV-FC

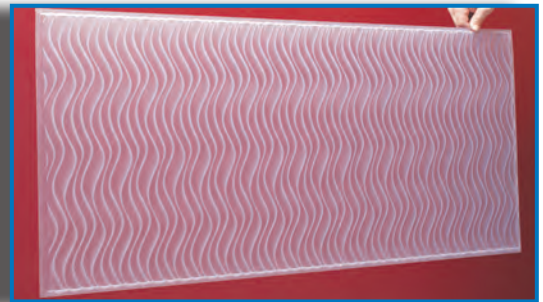

Basketweave: LD24-BAS-FC



Revolution: LD24-REV-FC

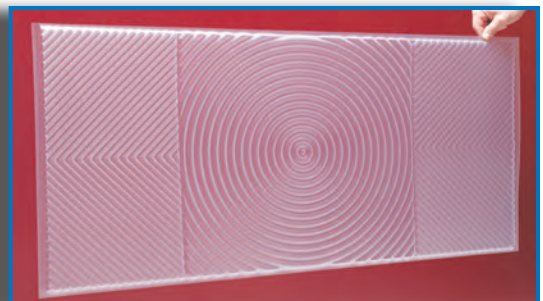

See page 738 for additional
Luminous Ceiling Tiles

POLYURETHANE NON-TEXTURED ORNAMENTS

SMOOTH CEILING ORNAMENTS

Manufactured of high density polyurethane, these plaster-like decorative ornaments are lightweight, primed and ready to paint.



DSA-109
5" Dia.
3/4" Depth

SHOWN:
DSA-165, DSA-167



DSA-167
6-5/8" H x 16-3/4" W
7/8" Depth



DSA-165
10" H x 16" W
5/8" Depth



DSA-154
12-1/4" H x 9" W
1-1/4" Depth

DSA-159
13" H x 8-1/2" W
1-1/4" Depth



SHOWN:
DSA-154,
DSA-159,
DSA-109

❖ To See Our Full Line
See Pages 458-461 ❖



Ceiling Corner

DSA-170
18-1/4" H x 18-1/4" W
2-1/4" Depth



Polyurethane Architectural Elements

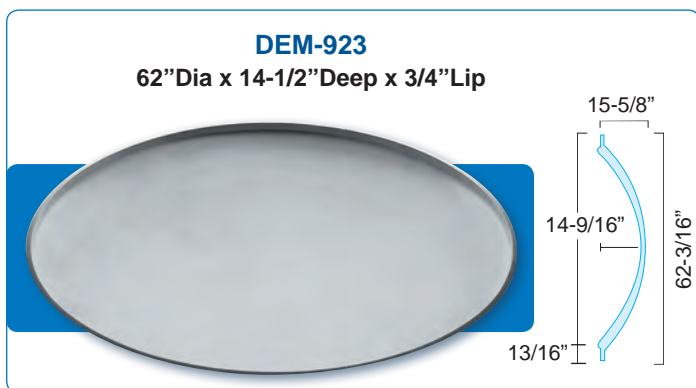
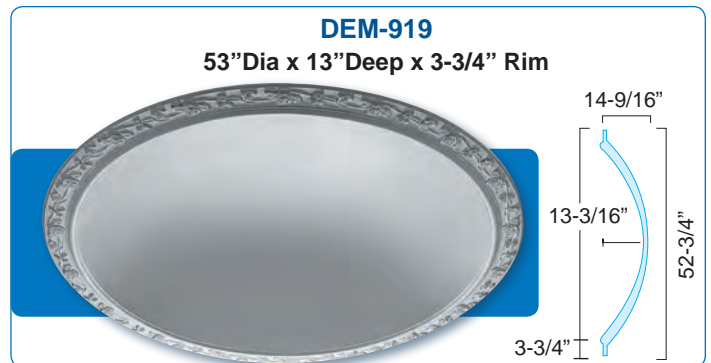
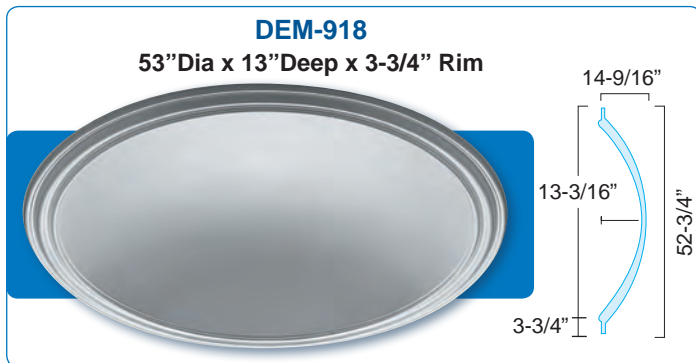
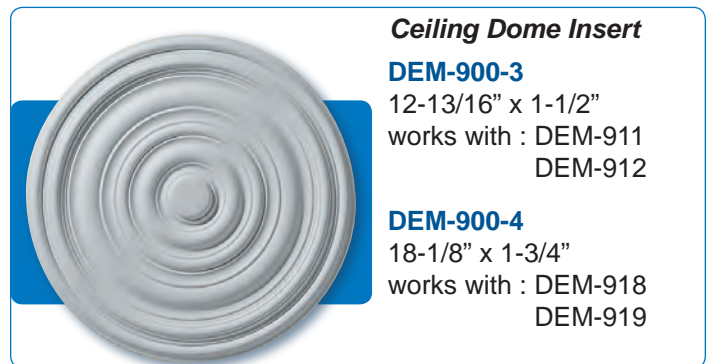
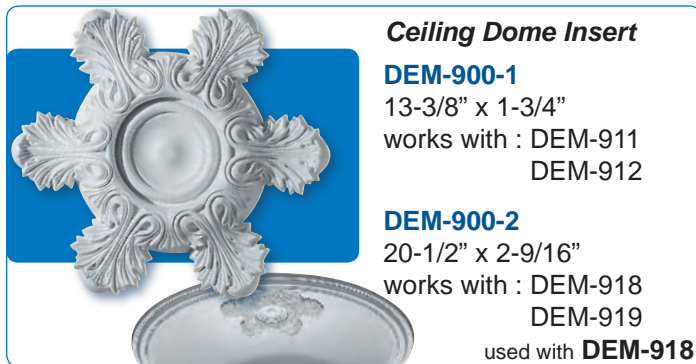
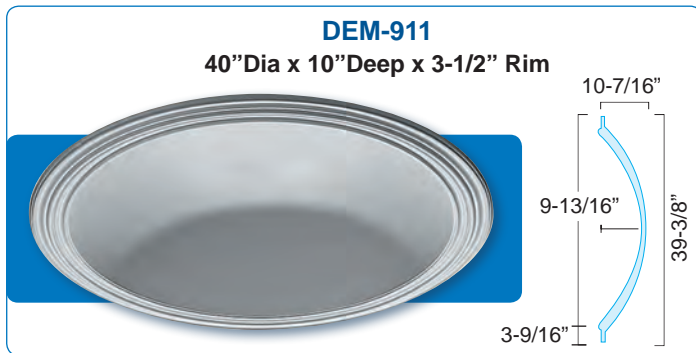

❖ **Orac Domes To Be Found On Page 774** ❖

All dimensions are approximate.

DECORATIVE RECESSED CEILING DOMES



Polyurethane Architectural Elements

DEM-905
27" Dia x 3" Deep x 1" Rim

DEM-908
36" Dia x 3" Deep x 4" Rim

DEM-915
44" x 36" Elliptical x 3" Deep x 4" Rim

DEM-922
60" Dia x 14" Deep x 5-1/2" Rim

DEM-926
71" Dia x 10" Deep x 3-1/2" Rim
28" *Medallion is Part of Mold

DEM-929
80" Dia x 18" Deep x 5" Rim
28" *Medallion is Part of Mold

SURFACE MOUNT CEILING DOMES

DEM-940
27-7/8" Dia x 4-5/16" Deep

Hole Dia: 4-3/8"
Hole Thickness: 1-3/4"
Inside Dia: 22-1/8"

❖ *Orac Domes To Be Found On Page 774* ❖

All dimensions are approximate.

FIBERGLASS DOMES



Create mystique within a room by changing the very shape and feel with a curved dome. Primarily decorative, domes increase the height of a room and allow for larger light fixtures.

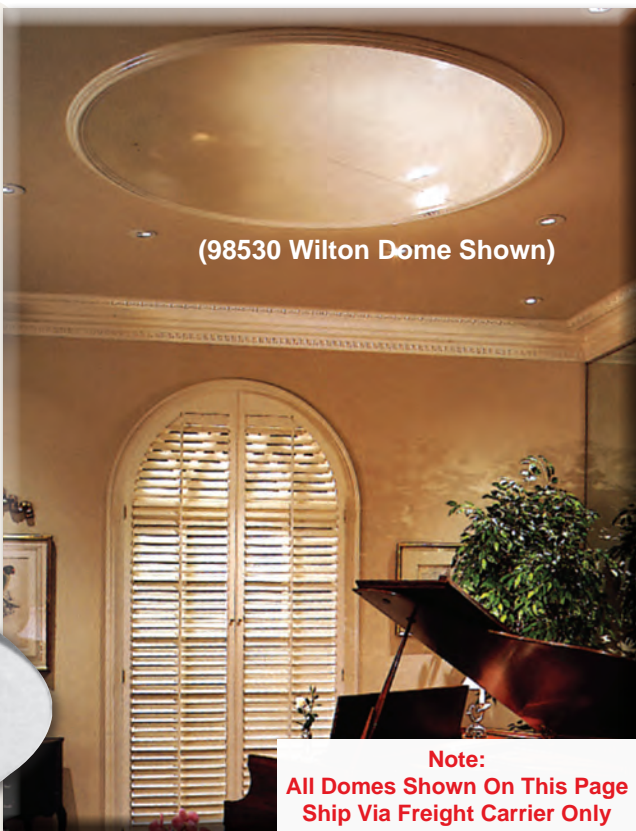
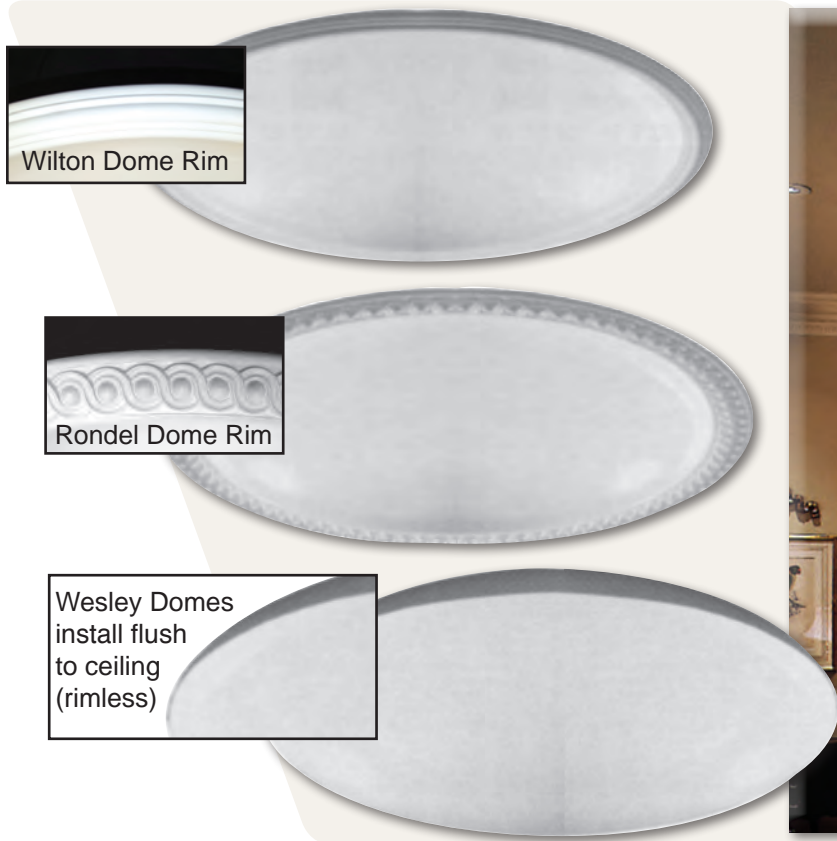

(98530 Wilton Dome Shown)

Note:
All Domes Shown On This Page
Ship Via Freight Carrier Only

PART #	SHAPE	OUTSIDE DIAMETER	ROUGH OPENING	OPENING DEPTH	MAXIMUM MEDALLION SIZE	WEIGHT
WILTON DOMES						
98520	Round	40-1/4"	36-1/2"	7-1/4"	12"	10.1 lbs.
98522	Round	52-1/4"	49-1/2"	15"	15"	16 lbs.
98530	Round	65-1/8"	60-3/4"	12-3/4"	18"	29 lbs.
98531	Round	77-3/8"	75-1/2"	16-1/2"	18"	48 lbs.
98540	Round	89-1/4"	84-3/4"	14-3/4"	24"	42 lbs.
98560	Elliptical	41" x 54"	35-1/2" x 48-1/2"	7-1/2"	12"	22 lbs.
98570	Elliptical	58-3/4" x 78"	54" x 73-1/2"	10-1/4"	18"	34 lbs.
RONDEL DOMES						
98523	Round	41-7/8"	36-1/2"	7-1/4"	12"	11.1 lbs.
98533	Round	65-3/4"	60-3/4"	12-3/4"	18"	35 lbs.
98563	Elliptical	41" x 54"	35-1/2" x 48-1/2"	7-1/2"	12"	17 lbs.
98573	Elliptical	58-3/4" x 78"	54" x 73-1/2"	10-1/4"	18"	33 lbs.
WESLEY DOMES (NO RIM)						
98525	Round	35-7/8"	36"	7-1/4"	12"	10 lbs.
98526	Round	47-3/8"	47-5/8"	15"	12"	12 lbs.
98535	Round	60"	60-1/4"	12-3/4"	18"	28 lbs.
98536	Round	72"	72-3/8"	15-1/2"	18"	42 lbs.
98545	Round	84"	84-3/4"	14-3/4"	24"	42 lbs.

Note: We offer the complete line of **Focal Point** products. If you do not see the **Focal Point** part you are looking for, Please inquire.



FIBERGLASS DOMES WITH ATTACHED LIGHT COVE

We introduce a dome with a manufactured light cove as one lightweight fiberglass unit that's easy to install and uniquely designed with a hidden light cove feature. All cove domes include white rope light - 25,000 hour life. Supplied with a light channel (or cove attached to domes) simply drop in the rope light.

The cove has a flat surface that can be left plain for a contemporary look or allows for the addition of flexible millwork designs. This allows the dome to blend with the decor of the home.

Additional Decorative Millwork options available below. Pricing includes domes and factory installed millwork, *but not painted.*

ROUND DECORATIVE BOW & SWAG COVE DOME (Pre-Molded)

PART #	OUTSIDE DIAMETER	ROUGH OPENING	OPENING DEPTH	RIM WIDTH	MAXIMUM MEDALLION SIZE
98521	78-5/8"	75-1/2"	15-1/2"	1-1/2"	20"



PLAIN COVE DOMES

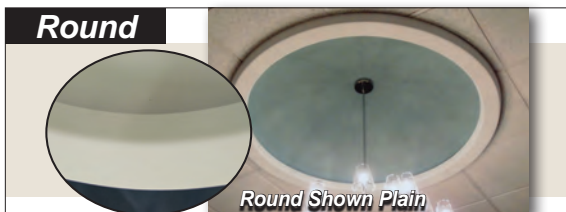

ROUND PLAIN COVE DOMES

PART #	OUTSIDE DIAMETER	ROUGH OPENING	OPENING DEPTH
98520-COVE*	42"	36-1/2"	6-1/4"
98522-COVE*	54"	49-1/2"	14"
98530-COVE*	67"	60-3/4"	11-3/4"
98550-COVE*	78-5/8"	73-1/2"	15-1/2"
98540-COVE*	91-1/4"	84-3/4"	13-3/4"

ELLIPTICAL PLAIN COVE DOMES

PART #	OUTSIDE DIAMETER	ROUGH OPENING	OPENING DEPTH
98560-COVE*	43" x 56"	35-1/2" x 48-1/2"	6-1/2"
98570-COVE*	61" x 80"	54" x 73-1/2"	9-1/4"

OPTIONAL DECORATIVE RIM MILLWORK

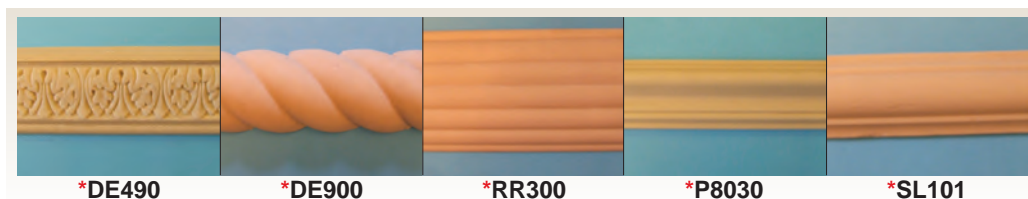

* ADD MILLWORK PART NUMBER ABOVE TO COVE DOME PART #. FOR EXAMPLE 98520-COVE-DE490

All cove domes with applied millwork are **special order - there are no cancellations or returns.**

Note: We offer the complete line of Focal Point products.

If you do not see the Focal Point part you are looking for, Please inquire.

“Europe’s #1 Choice for Interior Design”

NOTE: MEASUREMENTS ARE APPROXIMATE.



All the decorative elements in the ORAC DECOR Collection are produced in high density polyurethane, primed white. This material is extremely durable and easy to work with. It is tough, dimensionally stable, lightweight and easy to install using common woodworking tools and the Orac Decor adhesives. Adding elements from the ORAC DECOR Collection will enhance any new construction, renovation or redecoration project making a distinctive impression. The ORAC DECOR Collection offers a full range of decorative products reproduced from popular classic to contemporary designs.



F10

Surface Mount

(Item F10 requires no cutting - perfect for remodeling!)



F11

Recessed Mount



F12

Recessed Mount

PART #	STYLE	INSIDE DIA.	OUTSIDE DIA.	ROUGH OPENING	OVERALL DEPTH	INTERIOR DEPTH	WEIGHT
F10	Surface Mount	24-13/16"	35-1/4"	N/A	4-5/16"	3-7/8"	13 lbs.
F11	Small Recessed Mount	24-3/16"	29-5/16"	26-15/16"	3-3/4"	3-3/16"	8 lbs.
F12	Large Recessed Mount	44-7/8"	51-15/16"	48-13/16"	13"	12-3/8"	18 lbs.



CHANDELIER LIGHT LIFT



Now available: **A motorized lift system for your chandelier.** Dangerous ladders and expensive cleaning services are things of the past as chandeliers are quickly and safely lowered within easy reach from the floor for cleaning or replacement of bulbs.



Just Turn The Key!

Our new light lifts come with a special key switch, which can be conveniently installed in any new or existing wall. Releasing the key stops the chandelier at the height you choose. It's that easy!

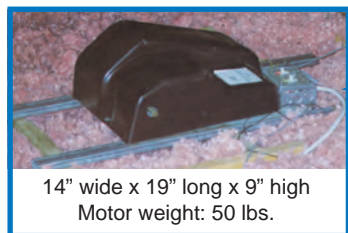

14" wide x 19" long x 9" high
Motor weight: 50 lbs.

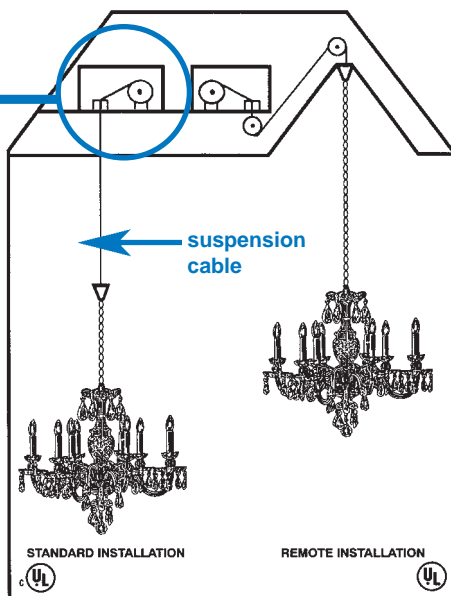

Place your order for a **"Standard Installation"** to be installed directly overhead; or....

....special order a **"Remote Installation"** unit for when you do not have enough overhead room, or for a sloped ceiling.

STANDARD INSTALLATION LIFTS

PART #	MAX. WEIGHT	MAX. WATTAGE
LL200	200 lbs.	1560 Watts
LL300	300 lbs.	1560 Watts

All "Standard Installation Lifts" include 120-volt motor with mounting brackets, all installation hardware, key switch with wall plate, 35 feet of suspension cable, and complete installation instructions.

For longer cable lengths, higher wattages, greater weight capacities, or remote installation kits, please inquire.

It is recommended that all electrical products be installed by a licensed electrician.

Ceiling Medallions

*For a complete line
see pages 809-812,
841-844, 854*



*The Chandelier Lift is
shown on page 775*

