

2014



BAR RAIL FITTINGS & COMPONENTS

BAR RAIL FITTINGS & COMPONENTS

Pgs. 895-909

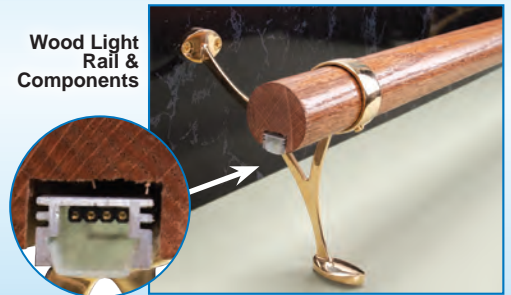

BAR RAIL FITTINGS & COMPONENTS

Ball Fittings.....	897
Cap Rail.....	904
Collars.....	902
Custom Bar Rails & Fittings.....	906
Dome Post Partitions & Components	
Center Post.....	904
Corner Post.....	904
Dome Post Partitions.....	904
End Post.....	904
Short Post Partitions.....	904
Tee Post.....	904
End Caps.....	902
Figurines.....	899
Flanges.....	901
Floor Mount Brackets.....	899-900
Flush Fittings.....	898
Glass Grips	
Economical Adjustable Zamac Metal.....	903

BAR RAIL FITTINGS & COMPONENTS

For Tubing.....	903
Standard Glass Grips.....	903
Glass Mount Handrail Bracket.....	903
Handrail Brackets.....	899-900
Handrail Mounting Brackets.....	900
Internal Splicer	
Overhead Glass Racks	
Custom Series.....	905
Stock Series.....	905
Saddles.....	902
Short Post Partitions & Components	
Center Post.....	904
Corner Post.....	904
End Post.....	904
Short Post Partitions.....	904
Tee Post.....	904
Waitress Station.....	904

BAR RAIL & RADIUS CORNERS

Corner.....	908-909
Rail.....	908-909

BAR RAIL TUBING..... 896

FOOT RAIL KITS

4-Foot Kits.....	895
6-Foot Kits.....	895
8-Foot Kits.....	895

HANDRAIL TUBING..... 896

SOLID WOOD HANDRAIL & FITTINGS

Easings.....	907
Level Quarter Turns.....	907
Rail Bolt Kit.....	907
Railing (Solid Wood).....	907
Returns.....	907
Rosettes.....	907

WOOD LIGHT RAIL & COMPONENTS

Wood Light Rail.....	896
----------------------	-----

SEE PAGES 1007-1023 FOR A - Z INDEX

FOOT RAIL KITS

FOOT RAIL KIT:



7 HIGH QUALITY FINISHES



2 WOOD FINISHES



Distinctive! Exclusive! Beautiful!

NOTE
 ALL COMPONENTS ARE FINISHED BY HAND. IT IS POSSIBLE THE PRODUCT FINISH WILL VARY FROM KIT TO KIT.



- High quality, commercial grade solid brass, 304 stainless steel, or perfectly doweled wood railing & components that will provide a professional and classic look!
- The railing is extremely durable, with a .050 wall thickness. The wood dowel has a solid core.
- The *Combination Brackets* can be attached to the face of the wall and rest on the floor for added support and stability.
- An *Internal Splicer* is included with the 8 ft. kit and will join together rails; simply space the combination bracket over the seam for a sleek look.
- *End Caps* included to complete the job!
- *Screws* supplied.

Includes 4 ft. 2" O.D. (.050 Wall Thickness) tube, 2 combination brackets, 2 end caps ^

4 Foot Kits:

PART #	RAIL	BRASS (*BR)	POLISHED STAINLESS (*CH) & SATIN STAINLESS STEEL (*SC)	ANTIQU BRASS (*ABRS), ANTIQU BRONZE (*ABRZ), ANTIQU COPPER (*ACOP) & OIL RUBBED BRONZE (*ORBZ)
S83-200-KIT4-*	Metal			
S83-200-K4-OK-*	Solid Oak			
S83-200-K4-MP-*	Solid Maple			

Includes 6 ft. 2" O.D. (.050 Wall Thickness) tube, 3 combination brackets, 2 end caps

6 Foot Kits:

PART #	RAIL	BRASS (*BR)	POLISHED STAINLESS (*CH)	ANTIQU BRASS (*ABRS), ANTIQU BRONZE (*ABRZ), ANTIQU COPPER (*ACOP) & OIL RUBBED BRONZE (*ORBZ)
S83-200-KIT6-*	Metal			

Includes (2) - 4 ft. 2" O.D. (.050 Wall Thickness) tube, 3 combination brackets, 2 end caps, 1 tube splicer ^

8 Foot Kits:

PART #	RAIL	BRASS (*BR)	POLISHED STAINLESS (*CH) & SATIN STAINLESS STEEL (*SC)	ANTIQU BRASS (*ABRS), ANTIQU BRONZE (*ABRZ), ANTIQU COPPER (*ACOP) & OIL RUBBED BRONZE (*ORBZ)
S83-200-KIT8-*	Metal			
S83-200-K8-OK-*	Solid Oak			
S83-200-K8-MP-*	Solid Maple			

^ Maple & Oak kits come with combination brackets only.

QUALITY TUBING FOR BAR RAIL AND HANDRAIL



Polished Brass
12 ft. Length Railing/Tubing

RAIL SIZE	PART #	WALL THICKNESS
1-1/2"	S82-150-BR	.050"
2"	S83-200-BR	.050"

304 Grade Polished Stainless Steel
12 ft. Length Railing/Tubing

RAIL SIZE	PART #	WALL THICKNESS
1-1/2"	S82-150-CH	.050"
2"	S83-200-CH	.050"

304 Grade (180 Grit) Satin Stainless Steel
4 ft. Length Railing/Tubing

RAIL SIZE	PART #	WALL THICKNESS
1-1/2"	SST-150-SC-4	.050"
2"	SST-200-SC-4	.050"

304 Grade (180 Grit) Satin Stainless Steel
8 ft. Length Railing/Tubing

RAIL SIZE	PART #	WALL THICKNESS
1-1/2"	SST-150-SC-8	.050"
2"	SST-200-SC-8	.050"

Solid Brass Lacquered
12 ft. Length Railing/Tubing

RAIL SIZE	PART #	WALL THICKNESS
1-1/2"	*S82-150LQ-BR	.050"
2"	*S83-200LQ-BR	.050"

Solid Brass Reeded
12 ft. Length Railing/Tubing

RAIL SIZE	PART #	WALL THICKNESS
1-1/2"	S82-150RDD-BR	.028"
2"	S83-200RDD-BR	.025"

Solid Brass Roped
12 ft. Length Railing/Tubing

RAIL SIZE	PART #	WALL THICKNESS
1-1/2"	S82-150RP-BR	.028"
2"	S83-200RP-BR	.032"

Maple
8 ft. Length Dowel

RAIL SIZE	PART #
1-1/2"	SWR-150-MP
2"	SWR-200-MP

Oak
8 ft. Length Dowel

RAIL SIZE	PART #
1-1/2"	SWR-150-OK
2"	SWR-200-OK

INTERNAL SPLICER

POLISHED BRASS FINISH
• For Joining 1-1/2" & 2" Railing



FITS RAIL	PART #
1-1/2"	S82-SPL-BR
2"	S83-SPL-BR

Polished Brass

Solid Brass Reeded

304 Grade Polished Stainless Steel

Solid Brass Roped

304 Grade (180 Grit) Satin Stainless Steel

Solid Maple (Unfinished)

Solid Brass Lacquered
*120 ft. Minimum

Solid Oak (Unfinished)

WOOD LIGHT RAIL

Works With All Standard Fittings

New

Maple	
8 ft. Length Dowel	
RAIL SIZE	PART #
1-1/2"	SWR-150-MP-LED
2"	SWR-200-MP-LED
Oak	
8 ft. Length Dowel	
RAIL SIZE	PART #
1-1/2"	SWR-150-OK-LED
2"	SWR-200-OK-LED



Solid Oak & Maple Rails are fitted with an aluminum channel & lens.

Your Choice of White or RGB LED

Close-Up Of Wood Foot Rail

Metal Channel

Lens

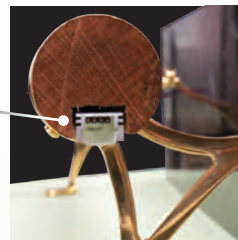

Works With LED's -

12V Eco Ribbon Flex (White)
For more details, see pgs. 658-659

24V Ribbon Flex (White)
For more details, see pgs. 648-649

24V Ribbon Flex (RGB)
For more details, see pgs. 650-651



Traditional Wood Meets Innovative Lighting & Ideas!

BAR RAIL FITTINGS & COMPONENTS

Finishes Available



Polished Brass (BN)



304 Grade (180 Grit) Satin Stainless Steel (SC)



304 Grade Polished Stainless Steel (CH)

Ball Single Outlet

Polished Brass

1-1/2" dia. **S82-199-BR** A: 3" B: 2-9/16"

2" dia. **S83-199-BR** A: 3-7/16" B: 3-1/4"

304 Grade (180 Grit) Satin Stainless Steel

1-1/2" dia. **SSF1-007-SC** A: 3" B: 2-9/16"

2" dia. **SSF2-007-SC** A: 3-3/8" B: 3-3/8"

304 Grade Polished Stainless Steel

1-1/2" dia. **S82-199-CH** A: 3" B: 2-9/16"

2" dia. **S83-199-CH** A: 3-3/8" B: 3-3/8"



Ball Side Outlet Elbow

Polished Brass

1-1/2" dia. **S82-205-BR** A: 2-13/16" B: 2-13/16"

2" dia. **S83-205-BR** A: 3-3/8" B: 3-3/8"

304 Grade (180 Grit) Satin Stainless Steel

1-1/2" dia. **SSF1-037-SC** A: 2-13/16" B: 2-13/16"

2" dia. **SSF2-037-SC** A: 3-3/8" B: 3-3/8"

304 Grade Polished Stainless Steel

1-1/2" dia. **S82-205-CH** A: 2-13/16" B: 2-13/16"

2" dia. **S83-205-CH** A: 3-3/8" B: 3-3/8"

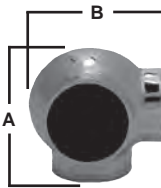

Ball Side Outlet Tee

Polished Brass

1-1/2" dia. **S82-206-BR** A: 3-1/4" B: 3-1/4"

2" dia. **S83-206-BR** A: 3-7/16" B: 3-7/16"

304 Grade (180 Grit) Satin Stainless Steel

1-1/2" dia. **SSF1-507-SC** A: 3-1/8" B: 3-1/2"

2" dia. **SSF2-507-SC** A: 3-3/8" B: 3-3/4"

304 Grade Polished Stainless Steel

1-1/2" dia. **S82-206-CH** A: 3-1/8" B: 3-1/2"

2" dia. **S83-206-CH** A: 3-3/8" B: 3-3/4"

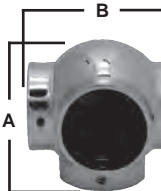

135° Ball Elbow

Polished Brass

1-1/2" dia. **S82-201-BR** A: 2-13/16" B: 2-13/16"

2" dia. **S83-201-BR** A: 4" B: 3-3/8"

304 Grade Polished Stainless Steel

1-1/2" dia. **S82-201-CH** A: 2-13/16" B: 2-3/8"

2" dia. **S83-201-CH** A: 4" B: 3-9/16"



BALL FITTINGS

90° Ball Elbow

Polished Brass

1-1/2" dia. **S82-202-BR** A: 2-13/16" B: 2-13/16"

2" dia. **S83-202-BR** A: 3-3/8" B: 3-3/8"

304 Grade (180 Grit) Satin Stainless Steel

1-1/2" dia. **SSF1-207-SC** A: 2-13/16" B: 2-13/16"

2" dia. **SSF2-207-SC** A: 3-3/8" B: 3-3/8"

304 Grade Polished Stainless Steel

1-1/2" dia. **S82-202-CH** A: 2-13/16" B: 2-13/16"

2" dia. **S83-202-CH** A: 3-3/8" B: 3-3/8"

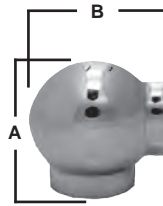

Ball Tee

Polished Brass

1-1/2" dia. **S82-203-BR** A: 2-15/16" B: 3-1/4"

2" dia. **S83-203-BR** A: 3-9/16" B: 3-11/16"

304 Grade (180 Grit) Satin Stainless Steel

1-1/2" dia. **SSF1-407-SC** A: 3-1/8" B: 3-1/2"

2" dia. **SSF2-407-SC** A: 3-3/8" B: 3-3/4"

304 Grade Polished Stainless Steel

1-1/2" dia. **S82-203-CH** A: 3-1/8" B: 3-1/2"

2" dia. **S83-203-CH** A: 3-3/8" B: 3-3/4"

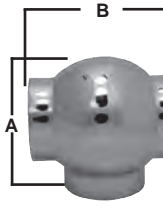

Ball Cross

Polished Brass

1-1/2" dia. **S82-204-BR** A: 3-1/4" B: 3-1/4"

2" dia. **S83-204-BR** A: 3-7/16" B: 3-7/16"

304 Grade (180 Grit) Satin Stainless Steel

1-1/2" dia. **SSF1-607-SC** A: 3-7/16" B: 3-7/16"

304 Grade Polished Stainless Steel

1-1/2" dia. **S82-204-CH** A: 3-7/16" B: 3-7/16"

2" dia. **S83-204-CH** A: 3-3/4" B: 3-3/4"

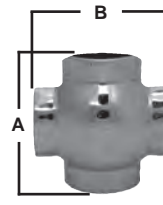

Ball Tee

304 Grade Polished Stainless Steel

2" dia. **S83-214-CH** A: 2-1/2" B: 1-1/4"



BAR RAIL FITTINGS & COMPONENTS

Finishes Available



Polished Brass (BN)



304 Grade (180 Grit) Satin Stainless Steel (SC)



304 Grade Polished Stainless Steel (CH)

FLUSH FITTINGS



Flush 135° Elbow

Polished Brass

1-1/2" dia.	S82-208-BR	A: 1-1/2"	B: 2"
2" dia.	S83-208-BR	A: 2"	B: 2"

304 Grade (180 Grit) Satin Stainless Steel

1-1/2" dia.	SSF1-307-SC	A: 1-1/2"	B: 1-1/2"
2" dia.	SSF2-307-SC	A: 1-3/4"	B: 1-3/4"

304 Grade Polished Stainless Steel

1-1/2" dia.	S82-208-CH	A: 1-1/2"	B: 1-1/2"
2" dia.	S83-208-CH	A: 1-3/4"	B: 1-3/4"

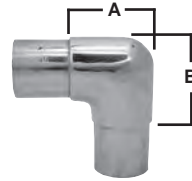

Flush 90° Elbow

Polished Brass

1-1/2" dia.	S82-209-BR	A: 2-5/16"	B: 2-5/16"
2" dia.	S83-209-BR	A: 2-3/8"	B: 2-3/8"

304 Grade (180 Grit) Satin Stainless Steel

1-1/2" dia.	SSF1-327-SC	A: 2-5/16"	B: 2-5/16"
2" dia.	SSF2-327-SC	A: 2-5/8"	B: 2-5/8"

304 Grade Polished Stainless Steel

1-1/2" dia.	S82-209-CH	A: 2-5/16"	B: 2-5/16"
2" dia.	S83-209-CH	A: 2-5/8"	B: 2-5/8"

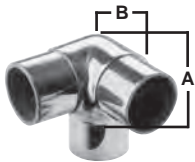

Flush Side Outlet Elbow

Polished Brass

1-1/2" dia.	S82-212-BR	A: 2"	B: 2"
304 Grade (180 Grit) Satin Stainless Steel			

1-1/2" dia.	SSF1-337-SC	A: 1-15/16"	B: 1-15/16"
2" dia.	SSF2-337-SC	A: 2-3/16"	B: 2-3/16"

304 Grade Polished Stainless Steel

1-1/2" dia.	S82-212-CH	A: 1-15/16"	B: 1-15/16"
-------------	------------	-------------	-------------

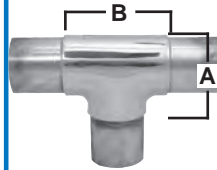

Flush Tee

Polished Brass

1-1/2" dia.	S82-210-BR	A: 2"	B: 2-5/16"
2" dia.	S83-210-BR	A: 2-7/16"	B: 2-9/16"

304 Grade (180 Grit) Satin Stainless Steel

1-1/2" dia.	SSF1-347-SC	A: 1-15/16"	B: 2-3/8"
2" dia.	SSF2-347-SC	A: 2-3/8"	B: 2-5/8"

304 Grade Polished Stainless Steel

1-1/2" dia.	S82-210-CH	A: 1-15/16"	B: 2-3/8"
2" dia.	S83-210-CH	A: 2-3/8"	B: 2-5/8"

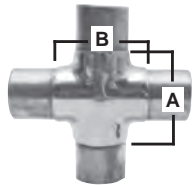

Flush Cross

Polished Brass

1-1/2" dia.	S82-211-BR	A: 2-3/8"	B: 2-3/8"
304 Grade (180 Grit) Satin Stainless Steel			

1-1/2" dia.	SSF1-365-SC	A: 2-3/8"	B: 2-3/8"
2" dia.	SSF2-365-SC	A: 2-13/16"	B: 2-13/16"



Flush Wall Return

Polished Brass

1-1/2" dia.	S82-243-BR	A: 3-1/8"	B: 3-1/8"
2" dia.	S83-243-BR	A: 3-1/16"	B: 3-1/16"

304 Grade (180 Grit) Satin Stainless Steel

1-1/2" dia.	SSF1-806-SC	A: 2-15/16"	B: 3-1/16"
2" dia.	SSF2-806-SC	A: 3-1/8"	B: 3-3/8"



Flush Wall Return

304 Grade (180 Grit) Satin Stainless Steel

1-1/2" dia.	SSF1-257-SC	A: 2-1/2"	B: 3"
2" dia.	SSF2-257-SC	A: 2-3/4"	B: 4"



Flush Radius Elbow

Polished Brass

1-1/2" dia.	S82-190-BR	A: 2-11/16"	B: 2-11/16"
2" dia.	S83-190-BR	A: 3-1/16"	B: 3-1/16"

304 Grade (180 Grit) Satin Stainless Steel

1-1/2" dia.	SSF1-317-SC	A: 2-1/2"	B: 2-1/2"
2" dia.	SSF2-317-SC	A: 3-15/16"	B: 3-15/16"

304 Grade Polished Stainless Steel

1-1/2" dia.	S82-190-CH	A: 2-1/2"	B: 2-1/2"
2" dia.	S83-190-CH	A: 3-15/16"	B: 3-15/16"



Flush 147° Elbow

304 Grade (180 Grit) Satin Stainless Steel

1-1/2" dia.	SSF1-730-SC	A: 1-3/4"	B: 1-3/4"
-------------	-------------	-----------	-----------



Flush Wall Mount Tee

304 Grade (180 Grit) Satin Stainless Steel

1-1/2" dia.	SSF1-457-SC	A: 2-1/4"	B: 3"
2" dia.	SSF2-457-SC	A: 3-1/8"	B: 4"



135° Flush Side Outlet Cross

304 Grade Polished Stainless Steel

2" dia.	S83-215-CH	A: 2-3/8"	B: 1-1/8"
---------	------------	-----------	-----------

FIGURINES

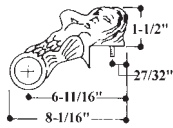

Mermaid
S83-MERM-BR

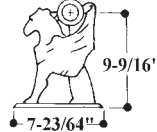

Pegasus
S83-PEGA-BR

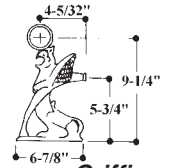

Griffin
S83-GRIF-BR

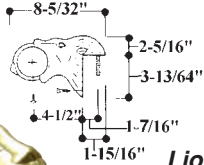

Lion
S83-LION-BR

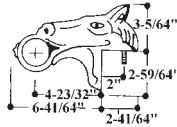

Horse
S83-HORS-BR

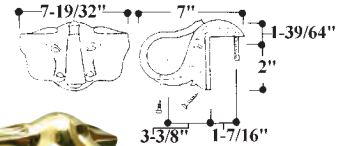

Elephant
S83-ELEP-BR

Finishes Available



Polished Brass (BN)



304 Grade (180 Grit) Satin Stainless Steel (SC)



304 Grade Polished Stainless Steel (CH)

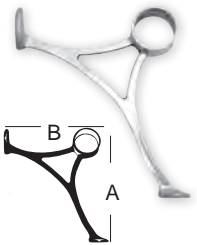

Combination Bracket

Polished Brass

1-1/2" dia. **S82-228-BR** A: 6-1/4" B: 6-1/64"
2" dia. **S83-228-BR** A: 5-13/16" B: 6-11/16"

304 Grade (180 Grit) Satin Stainless Steel

1-1/2" dia. **SSF1-104-SC** A: 5-5/16" B: 6-5/8"
2" dia. **SSF2-104-SC** A: 5-13/16" B: 6-11/16"

304 Grade Polished Stainless Steel

1-1/2" dia. **S82-228-CH** A: 5-5/16" B: 6-5/8"
2" dia. **S83-228-CH** A: 5-13/16" B: 6-11/16"



Victorian Footrail Bar Mount Bracket

Polished Brass

2" dia. **S83-247-BR** A: 6-3/16" B: 6-3/16"

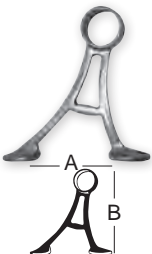

Footrail Floor Mount Bracket

Polished Brass

1-1/2" dia. **S82-230-BR** A: 6-3/4" B: 5-3/8"
2" dia. **S83-230-BR** A: 6-15/16" B: 6-15/16"

304 Grade (180 Grit) Satin Stainless Steel

1-1/2" dia. **SSF1-101-SC** A: 6-3/8" B: 6"
2" dia. **SSF2-101-SC** A: 7-5/16" B: 6-1/8"

304 Grade Polished Stainless Steel

1-1/2" dia. **S82-230-CH** A: 6-3/8" B: 6"
2" dia. **S83-230-CH** A: 7-5/16" B: 6-1/8"

FLOOR MOUNT & HANDRAIL BRACKETS

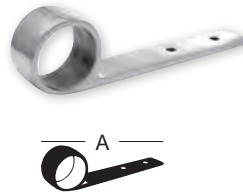

Elbow Rail Bracket

Polished Brass

1-1/2" dia. **S82-231-BR** A: 6-11/16" B: N/A
2" dia. **S83-231-BR** A: 7-3/32" B: N/A

304 Grade Polished Stainless Steel

1-1/2" dia. **S82-231-CH** A: 7-3/32" B: N/A

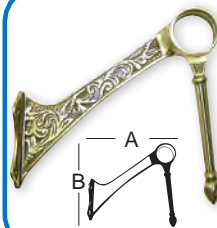

Footrail Floor Mount Bracket

Polished Brass

2" dia. **S83-254-BR** A: 8-5/16" B: 4-7/16"

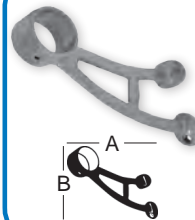

Footrail Bar Mount

Polished Brass

1-1/2" dia. **S82-229-BR** A: 7-1/16" B: 6-1/8"
2" dia. **S83-229-BR** A: 7-7/8" B: 6-5/16"

304 Grade (180 Grit) Satin Stainless Steel

1-1/2" dia. **SSF1-102-SC** A: 6-15/16" B: 6-1/8"
2" dia. **SSF2-102-SC** A: 8-1/8" B: 6-11/16"

304 Grade Polished Stainless Steel

1-1/2" dia. **S82-229-CH** A: 6-15/16" B: 6-1/8"
2" dia. **S83-229-CH** A: 8-1/8" B: 6-11/16"

BAR RAIL FITTINGS & COMPONENTS

Finishes Available



Polished Brass (BN)



304 Grade (180 Grit) Satin Stainless Steel (SC)



304 Grade Polished Stainless Steel (CH)

Handrail Bracket

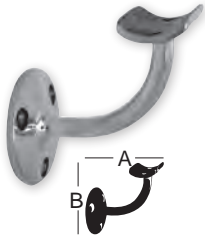

Polished Brass

1-1/2" dia. **S82-232-BR** A: 3-1/4" B: 3-1/4"
2" dia. **S83-232-BR** A: 3-1/4" B: 3-1/2"

304 Grade (180 Grit) Satin Stainless Steel

1-1/2" dia. **SSF1-103-SC** A: 3-1/4" B: 2-3/4"
2" dia. **SSF2-103-SC** A: 3-1/4" B: 3-1/2"

304 Grade Polished Stainless Steel

1-1/2" dia. **S82-232-CH** A: 3-1/4" B: 2-3/4"
2" dia. **S83-232-CH** A: 3-1/4" B: 3-3/8"

Curved Handrail Brackets



Polished Brass

1-1/2" dia. **S82-245-BR** A: 6-1/2" B: 6"
2" dia. **S83-245-BR** A: 6-7/8" B: 7"

Flat End Post

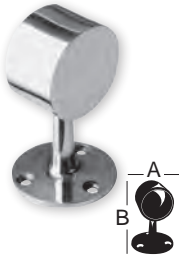

Polished Brass

1-1/2" dia. **S82-227-BRF** A: 1-3/4" B: 3-1/4"
2" dia. **S83-227-BRF** A: 2-1/4" B: 4-5/16"

304 Grade (180 Grit) Satin Stainless Steel

1-1/2" dia. **SSF1-403-SC** A: 1-3/4" B: 3-1/2"
2" dia. **SSF2-403-SC** A: 2-1/4" B: 4-1/2"

304 Grade Polished Stainless Steel

1-1/2" dia. **S82-227-CHF** A: 1-3/4" B: 3-1/2"
2" dia. **S83-227-CHF** A: 2-1/4" B: 4-1/2"

Ball End Post



Polished Brass

1-1/2" dia. **S82-227-BR** A: 2-1/4" B: 3-7/8"
2" dia. **S83-227-BR** A: 3-1/4" B: 4-1/4"

304 Grade (180 Grit) Satin Stainless Steel

1-1/2" dia. **SSF1-227-SC** A: 2-1/8" B: 3-7/8"
2" dia. **SSF2-227-SC** A: 2-11/16" B: 4-1/2"

304 Grade Polished Stainless Steel

1-1/2" dia. **S82-227-CH** A: 2-1/8" B: 3-7/8"
2" dia. **S83-227-CH** A: 2-11/16" B: 4-1/2"

FLOOR MOUNT & HANDRAIL BRACKETS

90° Handrail Bracket

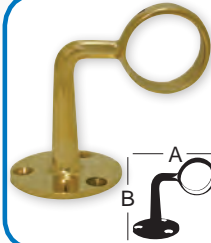

Polished Brass

1-1/2" dia. **S82-246-BR** A: 3-5/8" B: 4"
2" dia. **S83-246-BR** A: 4-1/4" B: 4-1/4"

Saddle Post



Polished Brass

1-1/2" dia. **S82-253-BR** A: 2-3/16" B: 2-1/4"
2" dia. **S83-253-BR** A: 2-5/8" B: 2-1/2"

304 Grade Polished Stainless Steel

1-1/2" dia. **S82-253-CH** A: 2-1/8" B: 2-1/4"
2" dia. **S83-253-CH** A: 2-5/8" B: 2-1/2"

Flush Center Post



Polished Brass

1-1/2" dia. **S82-226-BRF** A: 1-3/4" B: 3-3/8"
2" dia. **S83-226-BRF** A: 2-1/4" B: 4-5/16"

304 Grade (180 Grit) Satin Stainless Steel

1-1/2" dia. **SSF1-423-SC** A: 1-3/4" B: 3-1/2"
2" dia. **SSF2-423-SC** A: 2-1/4" B: 4-7/16"

304 Grade Polished Stainless Steel

1-1/2" dia. **S82-226-CHF** A: 1-3/4" B: 3-1/2"
2" dia. **S83-226-CHF** A: 2-1/4" B: 4-7/16"

Ball Center Post



Polished Brass

1-1/2" dia. **S82-226-BR** A: 2-1/4" B: 3-15/16"
2" dia. **S83-226-BR** A: 3-1/4" B: 4-1/4"

304 Grade (180 Grit) Satin Stainless Steel

1-1/2" dia. **SSF1-226-SC** A: 2-1/8" B: 3-3/16"
2" dia. **SSF2-226-SC** A: 2-11/16" B: 4-1/4"

304 Grade Polished Stainless Steel

1-1/2" dia. **S82-226-CH** A: 2-1/8" B: 3-13/16"
2" dia. **S83-226-CH** A: 2-11/16" B: 4-1/4"

HANDRAIL MOUNTING BRACKETS



Bracket

- Stocked In Rollbrite polished aluminum finish
- Hardware is included

WOOD HANDRAIL NOT INCLUDED

Clean, strong and unobtrusive, the unique two-piece design of these handrail mounting brackets reduces the cost and improves the quality of railing installation.

Heavy gauge cast aluminum brackets feature matching serrated surfaces that lock together eliminating slippage. These brackets meet or exceed OSHA and ADA standards. Brackets should be mounted at a maximum spacing of 36 inches into studs or blocking.

PART #	DESCRIPTION	SIZE
HR-203	For 7" Rail	1-3/4" x 2-7/8"
HR-303	For 5" Rail	2-1/2" x 1-3/4"

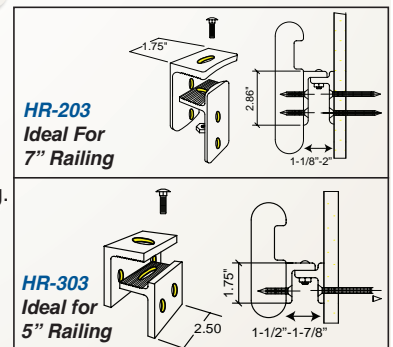

HR-203
Ideal For
7" Railing

HR-303
Ideal for
5" Railing

BAR RAIL FITTINGS & COMPONENTS

Finishes Available



Polished Brass (BN)



304 Grade (180 Grit) Satin Stainless Steel (SC)



304 Grade Polished Stainless Steel (CH)

Narrow Flange

Polished Brass

1-1/2" dia. **S82-221-BR** A: 1-7/8" B: 3"

2" dia. **S83-221-BR** A: 2-3/8" B: 3-7/8"

304 Grade (180 Grit) Satin Stainless Steel

1-1/2" dia. **SSF1-115-SC** A: 3-5/16" B: 2-3/16"

2" dia. **SSF2-115-SC** A: 4" B: 2-3/4"

304 Grade Polished Stainless Steel

1-1/2" dia. **S82-221-CH** A: 3-5/16" B: 2-3/16"

2" dia. **S83-221-CH** A: 4" B: 2-3/4"



Wall Flange

Polished Brass

1-1/2" dia. **S82-219-BR** A: 1-1/4" B: 3-15/16"

2" dia. **S83-219-BR** A: 1-7/16" B: 4-15/16"

304 Grade (180 Grit) Satin Stainless Steel

1-1/2" dia. **SSF1-105-SC** A: 1-3/16" B: 2-15/16"

2" dia. **SSF2-105-SC** A: 1-3/16" B: 3-15/16"

304 Grade Polished Stainless Steel

1-1/2" dia. **S82-219-CH** A: 1-3/16" B: 2-15/16"

2" dia. **S83-219-CH** A: 1-3/16" B: 3-15/16"

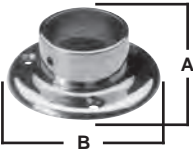

Half Flange

Polished Brass

1-1/2" dia. **S82-248-BR** A: 3" B: 1-1/4"

2" dia. **S83-248-BR** A: 4" B: 1-3/8"

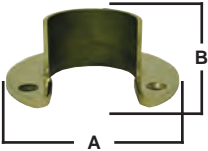

90° - 147° Adjustable Flange

Polished Brass

2" dia. **S83-251-BR** A: 2-15/16" B: 4"

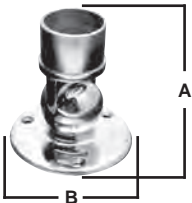

FLANGES

Floor Flange

Polished Brass

1-1/2" dia. **S82-220-BR** A: 1-3/16" B: 3"

2" dia. **S83-220-BR** A: 1-3/16" B: 4-1/16"

304 Grade (180 Grit) Satin Stainless Steel

1-1/2" dia. **SSF1-325-SC** A: 1-1/2" B: 4"

2" dia. **SSF2-325-SC** A: 1-1/2" B: 5"

304 Grade Polished Stainless Steel

1-1/2" dia. **S82-220-CH** A: 1-1/2" B: 4"

2" dia. **S83-220-CH** A: 1-1/2" B: 5"

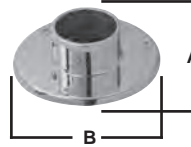

Angle Flange

Polished Brass

1-1/2" dia. **S82-250-BR** A: 2-3/16" B: 2-15/16"



Floor Canopy

Polished Brass

1-1/2" dia. **S82-218-BR** A: 1-9/16" B: 4"

2" dia. **S83-218-BR** A: 1-9/16" B: 4-15/16"

304 Grade (180 Grit) Satin Stainless Steel

2" dia. **SSF2-450-SC** A: 1-9/16" B: 4-13/16"

304 Grade Polished Stainless Steel

1-1/2" dia. **S82-218-CH** A: 1-9/16" B: 4-1/16"

2" dia. **S83-218-CH** A: 1-9/16" B: 4-13/16"

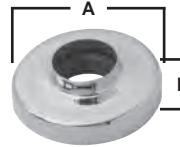

Steel Flange For Use With Canopy

- Provides extra support & strength.

1-1/2" dia. **S82-218SF-ST** A: 24" B: 3-1/2"

2" dia. **S83-218SF-ST** A: 12" B: 4-9/16"



Note: To be used with S82-218, S83-218*, & SSF2-450**

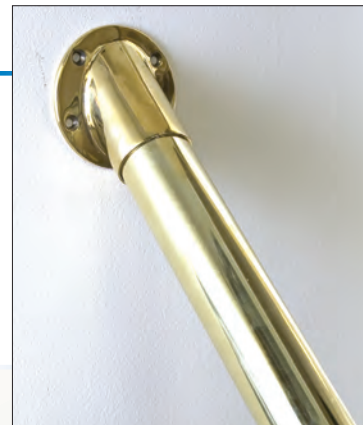
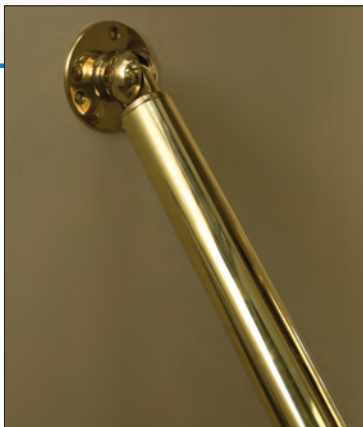

BAR RAIL FITTINGS & COMPONENTS

Finishes Available



Polished Brass (BN)



304 Grade (180 Grit) Satin Stainless Steel (SC)



304 Grade Polished Stainless Steel (CH)

Flush End Cap

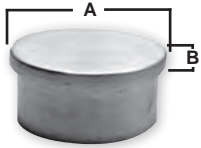

Polished Brass

1-1/2" dia.	S82-222-BR	A: 1-1/2"	B: 1/8"
2" dia.	S83-222-BR	A: 2"	B: 3/16"

304 Grade (180 Grit) Satin Stainless Steel

1-1/2" dia.	SSF1-206-SC	A: 1-1/2"	B: 1/8"
2" dia.	SSF2-206-SC	A: 2"	B: 3/16"

304 Grade Polished Stainless Steel

1-1/2" dia.	S82-222-CH	A: 1-1/2"	B: 1/8"
2" dia.	S83-222-CH	A: 2"	B: 3/16"

Ornate End Cap

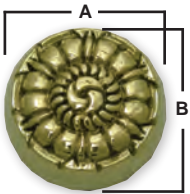

Polished Brass

1-1/2" dia.	S82-244-BR	A: 1-7/8"	B: 1"
2" dia.	S83-244-BR	A: 2-3/8"	B: 1-1/2"

Spring Caps



Polished Brass

1-1/2" dia.	S82-191-BR	A: 1-1/2"	B: 1/8"
2" dia.	S83-191-BR	A: 2"	B: 3/16"

304 Grade (180 Grit) Satin Stainless Steel

1-1/2" dia.	SSF1-106-SC	A: 1-1/2"	B: 1/8"
2" dia.	SSF2-106-SC	A: 2"	B: 3/16"

304 Grade Polished Stainless Steel

1-1/2" dia.	S82-191-CH	A: 1-1/2"	B: 1/8"
2" dia.	S83-191-CH	A: 2"	B: 3/16"

END CAPS

Domed End Cap



Polished Brass

1-1/2" dia.	S82-223-BR	A: 1-1/2"	B: 7/8"
2" dia.	S83-223-BR	A: 2"	B: 1"

304 Grade (180 Grit) Satin Stainless Steel

1-1/2" dia.	SSF1-602-SC	A: 1-1/2"	B: 3/4"
2" dia.	SSF2-602-SC	A: 2"	B: 1"

304 Grade Polished Stainless Steel

1-1/2" dia.	S82-223-CH	A: 1-1/2"	B: 3/4"
2" dia.	S83-223-CH	A: 2"	B: 1"

Outer End Cap



Polished Brass

2" dia.	S83-249-BR	A: 2-1/8"	B: 7/8"
---------	-------------------	-----------	---------

End Scroll



Polished Brass

1-1/2" dia.	S82-224-BR	A: 2-13/16"	B: 3"
2" dia.	S83-224-BR	A: 3"	B: 3-1/8"

304 Grade Polished Stainless Steel

1-1/2" dia.	S82-224-CH	A: 2-13/16"	B: 3"
2" dia.	S83-224-CH	A: 3"	B: 3-1/8"

Ball Top



Polished Brass

1-1/2" dia.	S82-225-BR	A: 3-5/16"	B: 2-7/16"
2" dia.	S83-225-BR	A: 4-1/2"	B: 3-1/8"

304 Grade Polished Stainless Steel

1-1/2" dia.	S82-225-CH	A: 3-5/16"	B: 2-7/16"
2" dia.	S83-225-CH	A: 4-1/2"	B: 3-1/8"

SADDLES & COLLARS

Perpendicular Collar



Polished Brass

2" dia.	S83-217-BR	A: 1-1/2"	B: 1"
---------	-------------------	-----------	-------

304 Grade (180 Grit) Satin Stainless Steel

2" dia.	SSF2-881-SC	A: 1-1/2"	B: 2-1/4"
---------	--------------------	-----------	-----------

304 Grade Polished Stainless Steel

2" dia.	S83-217-CH	A: 1-1/2"	B: 2-1/4"
---------	-------------------	-----------	-----------

Adjustable Saddle



Polished Brass

1-1/2" dia.	S82-234-BR	A: 3-1/2"	B: 1-1/2"
2" dia.	S83-234-BR	A: 4-3/8"	B: 2"

ECONOMIC ADJUSTABLE ZAMAC METAL GLASS GRIPS

BRUSHED STAINLESS STEEL

FITS RAIL	PART #	GLASS THICKNESS	"H"	"W"
A Flat Style	SSFZ-618F-SC	3/16" - 3/8"	2-9/64"	2-5/32"
B 1-1/2"	SSFZ1-618-SC	3/16" - 3/8"	2-9/64"	2-5/32"
C 2"	SSFZ2-618-SC	3/16" - 3/8"	2-9/64"	2-5/32"

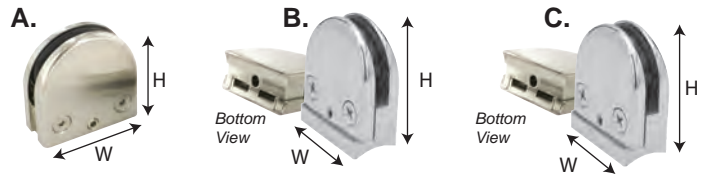

GLASS GRIPS FOR TUBING

POLISHED BRASS

FITS RAIL	GLASS THICKNESS	"H"	"W"	PART #
A 1-1/2"	1/4"	1-5/16"	2-1/2"	S82-108-BR
2"	1/4"	1-3/8"	2-1/2"	S83-108-BR

304 Grade (180 Grit) SATIN STAINLESS STEEL

FITS RAIL	GLASS THICKNESS	"H"	"W"	PART #
B 2"	1/2"	2"	1-3/4"	SSF2-813-SC
C 1-1/2"	1/4" - 5/16"	2"	1-9/16"	SSF1-618ADJ-SC
2"	1/4" - 5/16"	2-7/16"	1-3/4"	SSF2-618ADJ-SC

304 Grade POLISHED STAINLESS STEEL

FITS RAIL	GLASS THICKNESS	"H"	"W"	PART #
D 1-1/2"	1/4"	1-1/2"	2"	S82-108-CH
2"	1/4"	1-5/8"	2-9/16"	S83-108-CH

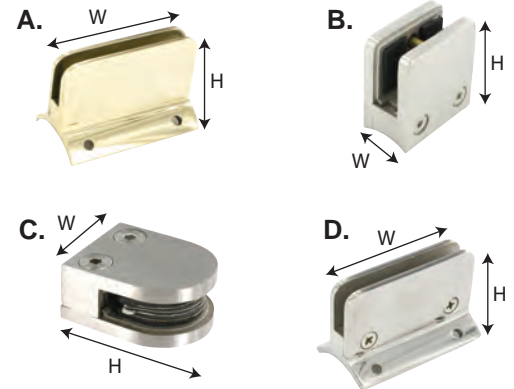

GLASS GRIPS

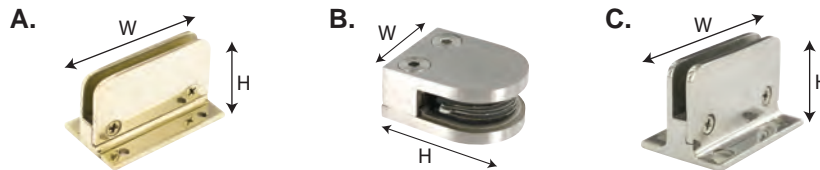

POLISHED BRASS

GLASS THICKNESS	"H"	"W"	PART #
A 1/4"	1-7/16"	2-1/2"	S83-108F-BR

304 Grade (180 Grit) SATIN STAINLESS STEEL

GLASS THICKNESS	"H"	"W"	PART #
B 1/4" - 5/16"	2"	1-9/16"	SSF-618FADJ-SC

304 Grade POLISHED STAINLESS STEEL

GLASS THICKNESS	"H"	"W"	PART #
C 1/4"	1-5/8"	2-9/16"	S83-108F-CH

GLASS MOUNT HANDRAIL BRACKET

304 Grade (180 GRIT) SATIN STAINLESS STEEL

FITS RAIL	GLASS THICKNESS	PART #
1-1/2"	1/2"	SSF1-340-SC
2"	1/2"	SSF2-340-SC



CAP RAIL & COMPONENTS

PART #	DESCRIPTION	FINISH	LENGTH
S82-700-BR	Solid Brass Channel for 1/4" glass	Polished Brass	6 ft.

SOLID BRASS CHANNEL

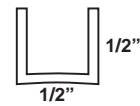

SHORT POST PARTITION

- 1-1/2" Diameter ONLY
- Recommended post spacing 36" to 48"



DOME POST PARTITION

- 1-1/2" or 2" Diameter
- Recommended post spacing 36" to 48"

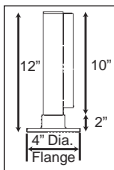
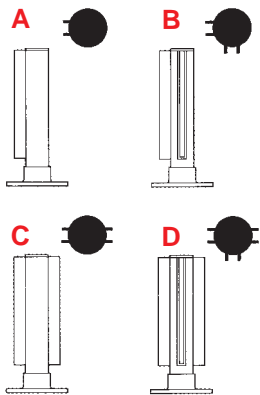
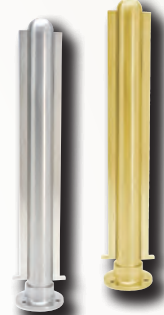

SHORT POST PARTITION SERIES

FITS RAIL	POLISHED BRASS	304 Grade (180 Grit) SATIN STAINLESS STEEL	304 Grade POLISHED STAINLESS STEEL
PART #	PART #	PART #	PART #
A. End Post			
1-1/2"	S82-SEND-BR	SSF-SEND-SC	S82-SEND-CH
B. Corner Post			
1-1/2"	S82-SCOR-BR	SSF-SCOR-SC	S82-SCOR-CH
C. Center Post			
1-1/2"	S82-SCEN-BR	SSF-SCEN-SC	S82-SCEN-CH
D. Tee Post			
1-1/2"	S82-STEE-BR	SSF-STEE-SC	S82-STEE-CH

WAITRESS STATION



Polished Brass
1-1/2" dia. S82-180E-BR
2" dia. S83-180E-BR



304 Grade Polished Stainless Steel
2" dia. S83-180E-CH

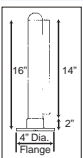
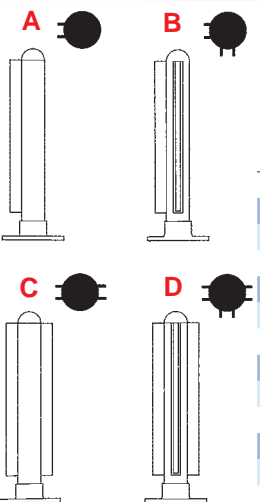

DOME POST PARTITION SERIES

FITS RAIL	POLISHED BRASS	304 Grade (180 Grit) SATIN STAINLESS STEEL	304 Grade POLISHED STAINLESS STEEL
PART #	PART #	PART #	PART #
A. End Post			
1-1/2"	S82-DEND-BR	SSF-DEND-SC	S82-DEND-CH
2"	S83-DEND-BR	SSF2-DEND-SC	S83-DEND-CH
B. Corner Post			
1-1/2"	S82-DCOR-BR	SSF-DCOR-SC	S82-DCOR-CH
2"	S83-DCOR-BR	SSF2-DCOR-SC	S83-DCOR-CH
C. Center Post			
1-1/2"	S82-DCEN-BR	SSF-DCEN-SC	S82-DCEN-CH
2"	S83-DCEN-BR	SSF2-DCEN-SC	S83-DCEN-CH
D. Tee Post			
1-1/2"	S82-DTEE-BR	SSF-DTEE-SC	S82-DTEE-CH
2"	S83-DTEE-BR	SSF2-DTEE-SC	S83-DTEE-CH

BAR RAIL FITTINGS & COMPONENTS



CHOOSE FROM OUR STOCK PROGRAM OR BUILD YOUR OWN!

OVERHEAD GLASS RACKS

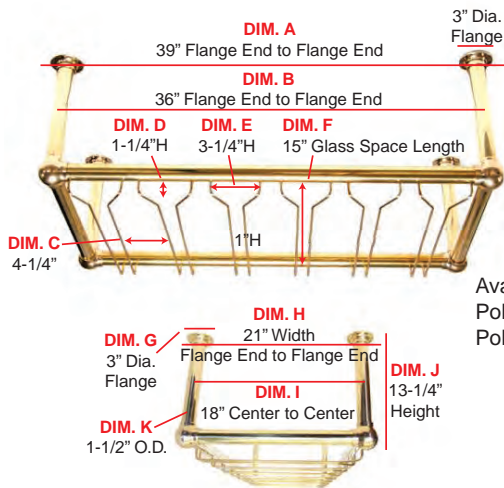

Great for all bars and kitchens!

Convenient, space-saving and stylish solution for Stemware.

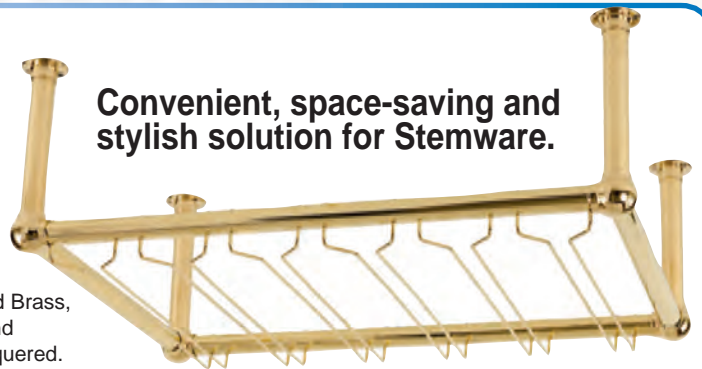

Available in Polished Brass, Polished Chrome and Polished Brass Lacquered.

PART #	FINISH	DESCRIPTION
S82-OHGR-BR	Polished Brass	3" base unit with 4 posts & 6 pairs of support rods - polished brass
S82-OHGR-CH	Polished Chrome	3" base unit with 4 posts & 6 pairs of support rods - polished chrome
S82-OHGR-LPB	Polished Brass Lacquered	3" base unit with 4 posts & 6 pairs of support rods - polished brass coated

CUSTOM OVERHEAD GLASS RACKS

////// We Can Customize Your Rack! ////

Please specify dimensions **A**, **I** (max. centerline width is 24") and **J** (max. height is 36") to meet your precise specifications. All other dimensions are as noted. Please call for quotation.

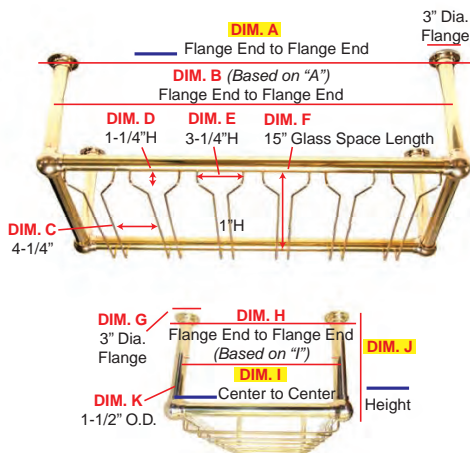

Custom Finishes Available:

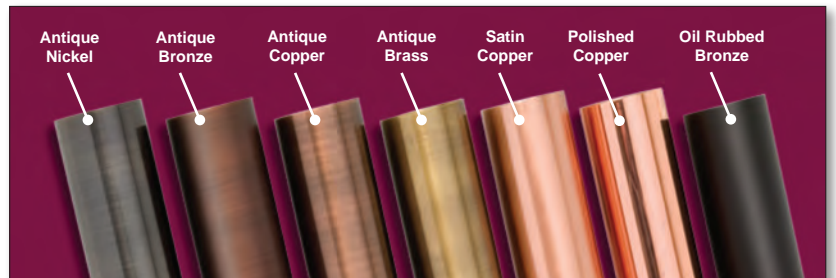

STANDARD RULE OF THUMB. THE DISTANCE FROM THE FLOOR TO THE BOTTOM OF THE GLASS RACK SHOULD BE 82".

BAR RAIL FITTINGS & COMPONENTS

CUSTOMIZE YOUR RAILS

CUSTOM BENDS

CUSTOMIZE YOUR RAILS!

We can create custom specified rails to meet your precise needs. Dimensions can be altered and additional finishes are available.

RADII

- 1. CHOOSE DIAMETER:**
1-1/2" or 2" Railing
- 2. CHOOSE A FINISH:**
Polished Brass,
Satin Stainless, or
Polished Stainless
- 3. BAR FACE LENGTH: A =**
- 4. BAR FACE RADIUS: B =**

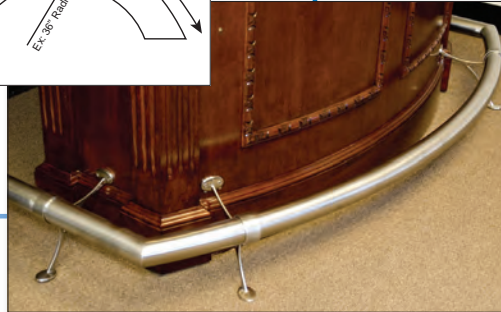
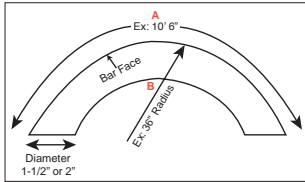

OTHER CUSTOM BENDS/MITRES

If your metal or steel railing requires fabrication such as a custom bent radius or custom mitred angles, please inquire

CUSTOM FINISHES

Custom Finishes Available:

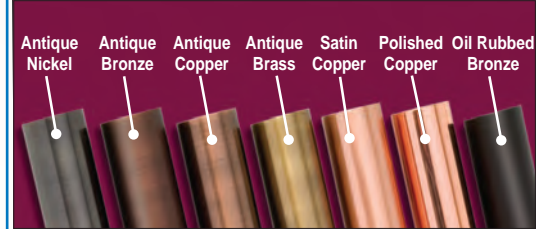

HELPFUL GUIDELINES FOR CUSTOM FINISHES

EXAMPLES ON CUSTOM FINISHES FOR TUBING & FITTINGS

- EXAMPLE 1:** 1½" O.D. or 2" O.D. Tube in any custom finish above
- EXAMPLE 2:** 2" O.D. Combination Bracket in any custom finish above
- EXAMPLE 3:** 2" O.D. Flat End Cap in any custom finish above

SEE OUR COMPLETE FLOOR MOUNT KITS ON PAGE 895

MANY CUSTOM COMPONENTS AVAILABLE

FLOOR MOUNTED SERVICE RAILS



OVERHEAD GLASS RACKS



DIVIDER RAILS



STAIR RISERS



SOLID WOOD HANDRAIL & FITTINGS



- Works with full round 1-1/2" & 2" railing
- 1-1/2" diameter fittings are fabricated from **SOLID STOCK**
- 2" diameter fittings are fabricated from **LAMINATED STOCK**
- Stocked in Red Oak and select sizes in Maple
- All components are finish sanded to 120 grit

RAIL BOLT KIT

Used to join fittings to wood railing.

INCLUDES:
5/16" x 3-1/2" bolt,
flange nut, curved washer
& oak plug.

RBK-WOOD



RETURNS

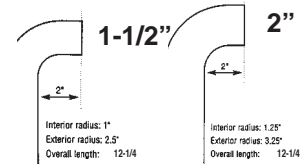

NEW UBC Code Requirements for handrail in commercial staircases designate an extra 12" of handrail past the joint at the top & bottom of staircase. In response to these requirements, we are now offering 12-1/4" returns.

DIAMETER	PART #	WOOD
1-1/2" x 12-1/4" L	S82W-RET-RO-12	Red Oak
	S82W-RET-MP-12	Maple
2" x 12-1/4" L	S83W-RET-RO-12	Red Oak
	S83W-RET-MP-12	Maple



SOLID WOOD RAILING
8 Ft. Lengths

DIAMETER	PART #	WOOD
1-1/2"	SWR-150-OK	Red Oak
	SWR-150-MP	Maple
2"	SWR-200-OK	Red Oak
	SWR-200-MP	Maple

LEVEL QUARTER TURNS

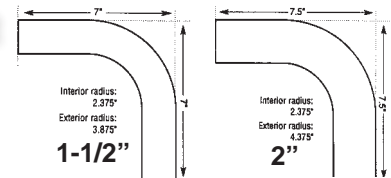

DIAMETER	PART #	WOOD
1-1/2"	S82W-LQT-RO	Red Oak
	S82W-LQT-MP	Maple
2"	S83W-LQT-RO	Red Oak

EASINGS

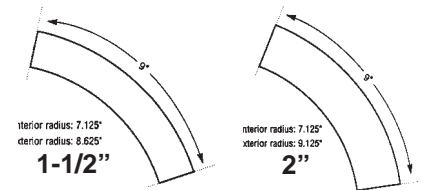

DIAMETER	PART #	WOOD
1-1/2"	S82W-EAS-RO	Red Oak
	S82W-EAS-MP	Maple
2"	S83W-EAS-RO	Red Oak
	S83W-EAS-MP	Maple

ROSETTES

Rosette for 1-1/2" Tube has a 3-1/2" Overall Dia.
Rosette for 2" has a 3-3/4" Overall Dia.



DIAMETER	PART #	WOOD
1-1/2"	S82W-ROS-RO	Red Oak
	S82W-ROS-MP	Maple
2"	S83W-ROS-RO	Red Oak



BAR RAIL & RADIUS CORNERS

**ALL PROFILES AVAILABLE
IN READY TO STAIN RED OAK**

***ALSO AVAILABLE IN CHERRY & MAPLE**

Introducing a line of bar rails and radius corners in the most popular profiles. These pieces coordinate beautifully with our full line of carvings, corbels and appliques.

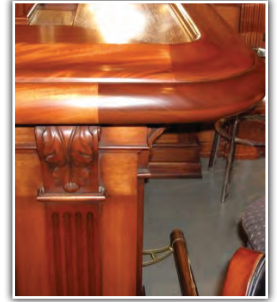

Wood Bar rails are typically installed at a slight downward angle by offsetting the edges of the bars top layers.

This creates a bold beautifully finished edge, not to mention a comfortable place to rest your arm.

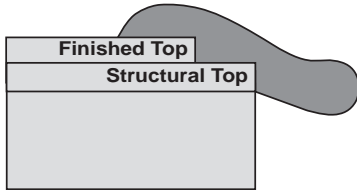

RAIL - 12' Lengths

BR-100-RO



CORNER

RC-100-RO

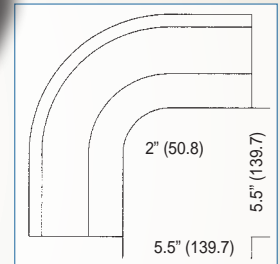
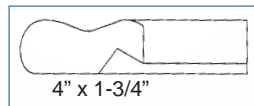

***Available In
Oak, Cherry
& Maple**

RAIL - 12' Lengths

BR-200-RO

BR-200-CH

BR-200-MP



CORNER

RC-200-RO

RC-200-CH

RC-200-MP

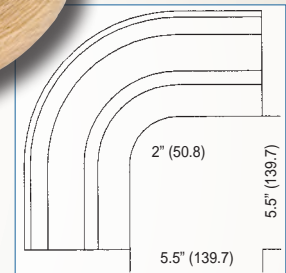
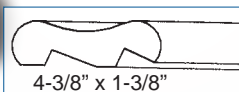

See Our Full Line of Brass Bar Rails & Fittings on pages 896-906

BAR RAIL & RADIUS CORNERS

ALL PROFILES AVAILABLE IN READY TO STAIN RED OAK
**ALSO AVAILABLE IN CHERRY & MAPLE*

**Available In
Oak, Cherry
& Maple*

RAIL - 12' Lengths

BR-300-RO
BR-300-CH
BR-300-MP

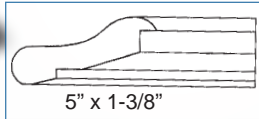

5" x 1-3/8"



CORNER

RC-300-RO
RC-300-CH
RC-300-MP

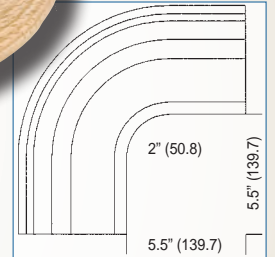

RAIL - 12' Lengths

BR-400-RO

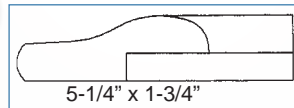

5-1/4" x 1-3/4"



CORNER

RC-400-RO

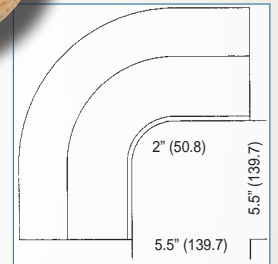

RAIL - 12' Lengths

BR-500-RO

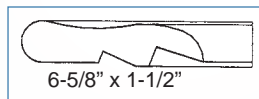

6-5/8" x 1-1/2"



CORNER

RC-500-RO

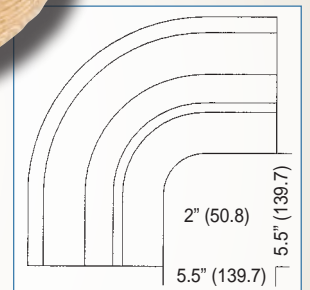

See Our Full Line of Brass Bar Rails & Fittings on pages 896-906